

PJ6KPS-CA

Installation, operational & maintenance manual
VOLUME 1





Notification of intended purpose and limitations of product use

This product is a FM transmitter intended for FM audio broadcasting. It utilises operating frequencies not harmonised in the intended countries of use. The user must obtain a license before using the product in intended country of use. Ensure respective country licensing requirements are complied with. Limitations of use can apply in respect of operating frequency, transmitter power and/or channel spacing.

Declaration of Conformity

Hereby, R.V.R. Elettronica SpA, declares that this FM transmitter is in compliance with the essential requirements and other relevant provisions of Directive 1999/5/EC.



Waste Electrical or Electronic Equipment (WEEE)



This symbol indicates that you should not discard waste electrical or electronic equipment (WEEE) in the trash. For proper disposal, contact your local recycling/reuse or hazardous waste center.



CAUTION

Do not discard waste electrical or electronic equipment (WEEE) in the trash. For proper disposal, contact your local recycling/reuse or hazardous waste center.

Index

1.	Preliminary instructions.....	1
2.	Warranty.....	2
3.	First Aid.....	2
3.1	Electric shock treatment.....	2
3.1.1	If the victim is unconscious.....	2
3.1.2	If the victim is conscious.....	2
3.2	Treatment of electric burns.....	2
3.2.1	Large burns and broken skin.....	2
3.2.2	Minor burns.....	2
4.	General Description.....	3
4.1	Composition.....	3
4.2	Technical specifications.....	4
4.3	Options.....	5
4.4	Operating principles.....	6
4.5	Module failure.....	7
5.	Control unit (CU).....	10
5.1	LCD Display.....	11
5.1.1	Overall status menu.....	12
5.1.2	Select menu.....	13
5.1.3	Control unit menu.....	13
5.1.4	Power supply menu.....	14
5.1.5	R.F. combiner menu.....	15
5.1.6	R.F. units menu.....	16
5.1.7	Alarms menu.....	17
5.1.8	Service menu.....	17
5.1.9	Settings menu.....	18
5.1.10	Exciters menu.....	19
5.1.11	Info menu.....	20
5.1.12	Release menu.....	21
5.1.13	Modem menu.....	22
5.2	Buttons, selector switches and LEDs.....	23
5.3	Alarms.....	25
6.	Details principal, Components and Sub-Systems.....	27
6.1	Control unit (CU).....	30
6.1.1	Settings motherboard control unit.....	31
6.2	RF module.....	33
6.2.1	Settings CPU board (RF Module).....	37
6.3	Electromechanical section.....	38
6.3.1	P.S. combiner (PF1ADPSPJ5KM).....	39
6.3.2	P.S. combiner trimmer.....	40
6.4	Parallel interface (INTREMPJ5K).....	42
6.4.1	Interlock dummy load / transmitter.....	46
6.5	RF Module box.....	47
6.5.1	Tray fans (CASVTLMPJ10KVC).....	48
6.5.1.1	PCB fan voltage.....	49
6.5.2	RF module address.....	51
6.5.3	Power distribution board tray fans (CSALVTL2KWPJ).....	52
6.5.4	Power supply tray fans.....	54

6.6	Combiner and Splitter.....	55
6.6.1	RF combiner schematic.....	56
6.6.2	Splitter board trimmers.....	57
6.7	Installation emergency CCU Board (SLCCUEMPJ5K1).....	58
6.8	Services supply.....	62
6.9	PJ6KPS-CA Ventilation.....	63
6.10	Input socket.....	64
6.11	Rejected load.....	65
6.11.1	Wiring diagrams.....	67
6.11.2	Settings Absorber misure board (SLADKDIPK5K3).....	69
6.11.3	Settings unbalancement measure board.....	70
6.12	Light current arrester.....	71
7.	Unpacking, installation and use.....	73
7.1	Assembly.....	73
7.2	First start.....	75
7.3	Preliminary operation.....	75
7.4	Power-on.....	76
7.5	Control unit settings.....	76
7.6	Management of the exciters.....	78
7.6.1	Start-up from power-on with exciters in manual mode.....	78
7.6.2	From OFF to ON with exciters in manual.....	78
7.6.3	Automatic changeover.....	79
7.6.4	Phase from ON to OFF.....	79
7.6.5	Start-up with exciters in automatic mode.....	80
7.6.6	Audio alarm.....	80
7.6.7	Protection and alarms.....	81
8.	Troubleshooting.....	82

IMPORTANT



The symbol of lightning inside a triangle placed on the product, evidences the operations for which is necessary gave it full attention to avoid risk of electric shocks.



The symbol of exclamation mark inside a triangle placed on the product, informs the user about the presence of instructions inside the manual that accompanies the equipment, important for the efficacy and the maintenance (repairs).

1. Preliminary Instructions

• General Warnings

This equipment should only be operated, installed and maintained by “trained” or “qualified” personnel who are familiar with risks involved in working on electric and electronic circuits. “Trained” means personnel who have technical knowledge of equipment operation and who are responsible for their own safety and that of other unqualified personnel placed under their supervision when working on the equipment. “Qualified” means personnel who are trained in and experienced with equipment operation and who are responsible for their own safety and that of other unqualified personnel placed under their supervision when working on the equipment.

⚡ WARNING: Residual voltage may be present inside the equipment even when the ON/OFF switch is set to Off. Before servicing the equipment, disconnect the power cord or switch off the main power panel and make sure the safety earth connection is connected. Some service situations may require inspecting the equipment with live circuits. Only trained and qualified personnel may work on the equipment live and shall be assisted by a trained person who shall keep ready to disconnect power supply at need.

R.V.R. Elettronica S.r.l. shall not be liable for injury to persons or damage to property resulting from improper use or operation by trained/untrained and qualified/unqualified persons.

⚡ WARNING: The equipment is not water resistant. Any water entering the enclosure might impair proper operation. To prevent the risk of electrical shock or fire, do not expose this equipment to rain, dripping or moisture.

Please observe local codes and fire prevention rules when installing and operating this equipment.

⚡ WARNING: This equipment contains exposed live parts involving an electrical shock hazard. Always disconnect power supply before removing any covers or other parts of the equipment.

Ventilation slits and holes are provided to ensure reliable operation and prevent overheating; do not obstruct or cover these slits. Do not obstruct the ventilation slits under any circumstances. The product must not be incorporated in a rack unless adequate ventilation is provided or the manufacturer’s instructions are followed closely.

⚠ WARNING: This equipment can radiate radiofrequency energy and, if not installed in compliance with manual instructions and applicable regulations, may cause interference with radio communications.

⚠ WARNING: This equipment is fitted with earth connections both in the power cord and for the chassis. Make sure both are properly connected.

Operation of this equipment in a residential area may cause radio interference, in which case the user may be required to take adequate measures.

The specifications and data contained herein are provided for information only and are subject to changes without prior notice. R.V.R. Elettronica S.r.l. disclaims all warranties, express or implied. While R.V.R. Elettronica S.r.l. attempts to provide accurate information, it cannot accept responsibility or liability for any errors or inaccuracies in this manual, including the products and the software described herein. R.V.R. Elettronica S.r.l. reserves the right to make changes to equipment design and/or specifications and to this manual at any time without prior notice.

• Notice concerning product intended purpose and use limitations.

This product is a radio transmitter suitable for frequency-modulation audio radio broadcasting. Its operating frequencies are not harmonised in designated user countries. Before operating this equipment, user must obtain a licence to use radio spectrum from the competent authority in the designated user country. Operating frequency, transmitter power and other characteristics of the transmission system are subject to restrictions as specified in the licence.

2. Warranty

La R.V.R. Elettronica S.r.l. warrants this product to be free from defects in workmanship and its proper operation subject to the limitations set forth in the supplied Terms and Conditions. Please read the Terms and Conditions carefully, as purchase of the product or acceptance of the order acknowledgement imply acceptance of the Terms and Conditions. For the latest updated terms and conditions, please visit our web site at WWW.RVR.IT. The web site may be modified, removed or updated for any reason whatsoever without prior notice. The warranty will become null and void in the event the product enclosure is opened, the product is physically damaged, is repaired by unauthorised persons or is used for purposes other than its intended use, as well as in the event of improper use, unauthorised changes or neglect. In the event a defect is found, follow this procedure:

- 1 Contact the seller or distributor who sold the equipment; provide a description of the problem or malfunction for the event a quick fix is available.

Sellers and Distributors can provide the necessary information to troubleshoot the most frequently encountered problems. Normally, Sellers and Distributors can offer a faster repair service than the Manufacturer would. Please note that Sellers can pinpoint problems due to wrong installation.

- 2 If your Seller cannot help you, contact R.V.R. Elettronica S.r.l. and describe the problem; if our staff deems it appropriate, you will receive an authorisation to return the equipment along with suitable instructions;
- 3 When you have received the authorisation, you may return the unit. Pack the unit carefully before shipment; use the original packaging whenever possible and seal the package perfectly. The customer bears all risks of loss (i.e., R.V.R. shall not be liable for loss or damage) until the package reaches the R.V.R. factory. For this reason, we recommend insuring the goods for their full value. Returns must be sent on a C.I.F. basis (PREPAID) to the address stated on the authorisation as specified by the R.V.R. Service Manager.



Units returned without a return authorisation may be rejected and sent back to the sender.

- 4 Be sure to include a detailed report mentioning all problems you have found and copy of your original invoice (to show when the warranty period began) with the shipment.

Please send spare and warranty replacement parts orders to the address provided below. Make sure to specify equipment model and serial number, as well as part description and quantity.



R.V.R. Elettronica S.r.l.
Via del Fonditore, 2/2c
40138 BOLOGNA ITALY
Tel. +39 051 6010506

3. First Aid

All personnel engaged in equipment installation, operation and maintenance must be familiar with first aid procedures and routines.

3.1 Electric shock treatment

3.1.1 If the victim is unconscious

Follow the first aid procedures outlined below.

- Lay the victim down on his/her back on a firm surface.
- the neck and tilt the head backwards to free the airway system (**Figure 1**).

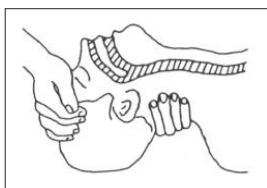

Figure 1

- If needed, open the victim's mouth and check for breathing.
- If there is no breathing, start artificial respiration without delay (**Figure 2**) as follows: tilt the head backwards, pinch the nostrils, seal your mouth around the victim's mouth and give four fast rescue breaths.



Figure 2

- Check for heartbeat (**Figure 3**); if there is no heartbeat, begin chest compressions immediately (**Figure 4**) placing your hands in the centre of the victim's chest (**Figure 5**).

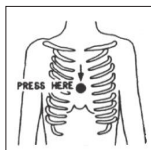
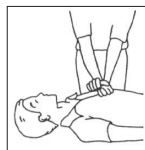
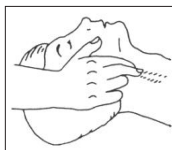

Figure 3

Figure 4

Figure 5

- One rescuer: give 2 quick rescue breaths after each 15 compressions.

- Two rescuers: one rescue breath after each 5 compressions.
- Do not stop chest compressions while giving artificial breathing.
- Call for medical help as soon as possible.

3.1.2 If the victim is conscious

- Cover victim with a blanket.
- Try to reassure the victim.
- Loosen the victim's clothing and have him/her lie down.
- Call for medical help as soon as possible.

3.2 Treatment of electric burns

3.2.1 Large burns and broken skin

- Cover affected area with a clean cloth or linen.
- Do not break any blisters that have formed; remove any clothing or fabric that is stuck to the skin; apply adequate ointment.
- Administer adequate treatment for the type of accident.
- Get the victim to a hospital as quickly as possible.
- Elevate arms and legs if injured.

If medical help is not available within an hour, the victim is conscious and is not retching, administer a solution of table salt and baking soda (one teaspoon of table salt to half teaspoon of baking soda every 250 ml of water).

Have the victim slowly drink half a glass of solution for four times during a period of 15 minutes.

Stop at the first sign of retching.

Do not administer alcoholic beverages.

3.2.2 Minor burns

- Apply cold (not ice cold) strips of gauze or dress wound with clean cloth.
- Do not break any blisters that have formed; remove any clothing or fabric that is stuck to the skin; apply adequate ointment.
- If needed, have the victim change into clean, dry clothing.
- Administer adequate treatment for the type of accident.
- Get the victim to a hospital as quickly as possible.
- Elevate arms and legs if injured.

4. General Description

The PJ6KPS-CA is a RF amplifier for frequency modulation sound broadcasting. It is a fully solid-state transmitter of modern design that uses LD MOSFET as active components in the FM amplifying modules. This chapter briefly describes the transmitter’s main features.

4.1 Composition

The TXF6K-0161 transmitter is made up of modules inserted in a 19” rack. The main devices are:

- 2x professional Exciter
- 3x RF amplifier modules at 2.2 kW nominal
- 1x Control unit (CU)
- 1x Splitter/Input RF
- 1x Rejected Load

In configuration standard it comes supplied with Rack from 40 unit.

RACK SIZE	A	B	C	D
40U	685 mm	1935 mm	1970 mm	1000 mm

FRONTAL VIEW

SIDE VIEW

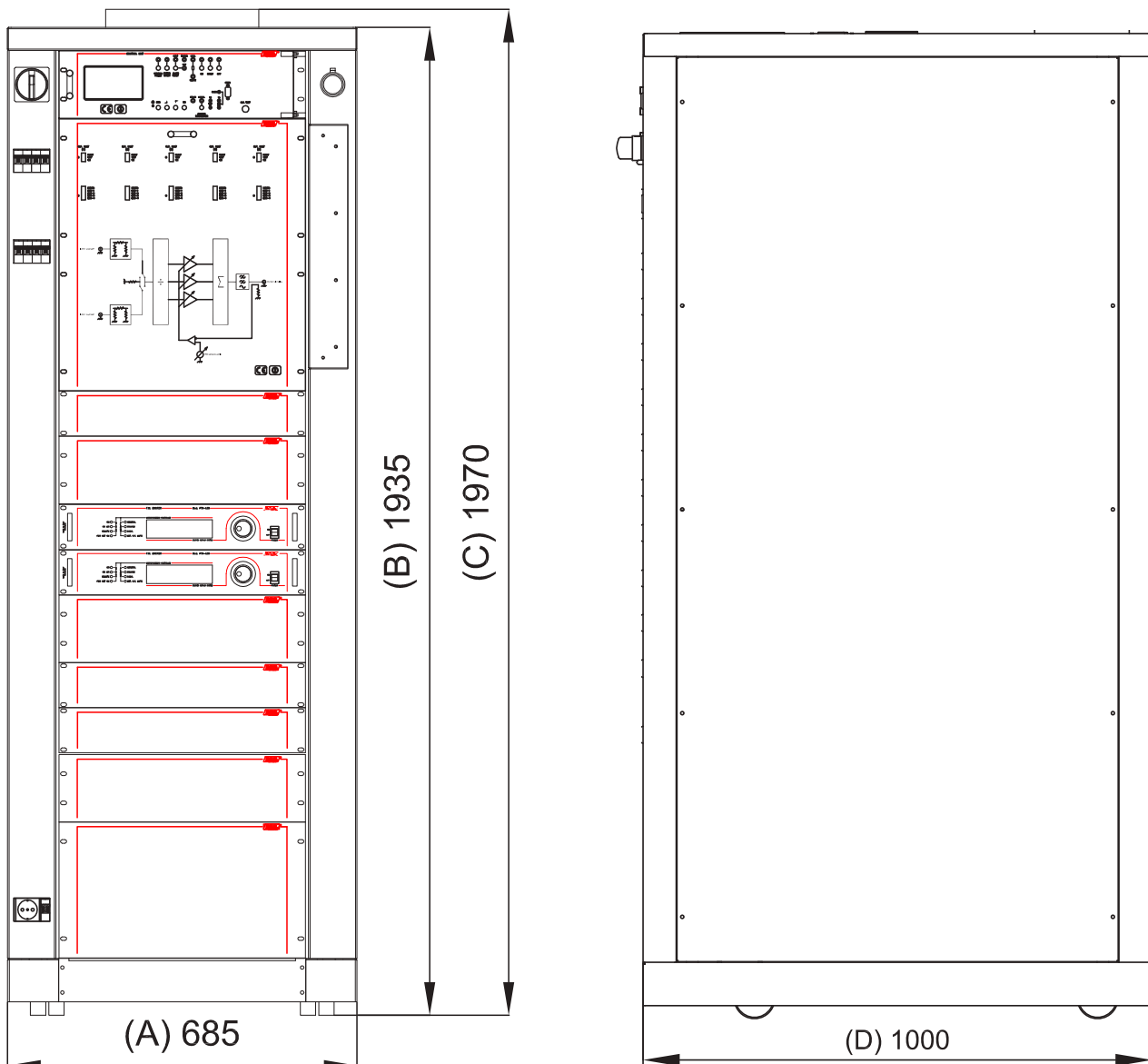

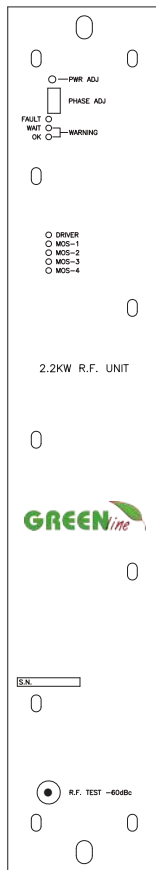

Amplifier module
(Front view)



Amplifier module
(Rear view)

The amplifier is supplied complete with all its parts, not really "modules", essential for its operation such as the fans for dissipating the heat generated by the transmitter inside the room and all the accessories for the electrical and RF wiring. As a rule, the amplifier is supplied as a complete transmitter therefore the two FM exciters that it manages will be provided and connected (a service exciter and a spare exciter).

4.2 Technical specifications

Frequency range:	87.5 to 108.0 MHz without any tunings
Nominal RF power:	6,000 W
Power supply voltage:	400V ±10% AC Three-phase, 3P+N 230V ±10% AC Three-phase, 3P+N 230V ±10% AC Mono-Phase 50/60 Hz
Frequency:	50/60Hz ±2Hz
Exciting power:	Max 30 W
Consumption:	about 8.5 KW Typical
Power factor:	> 0.95
Efficiency:	70 %
Weight:	~350 kg (rack) - 18 kg (module)
Nominal frequency deviation:	± 75 KHz (peak)
Maximum frequency deviation:	± 100 KHz (peak)
Rated output (load) impedance:	50 ohm unbalanced
Permissible VSWR:	The permissible VSWR is 1.5:1 with full power with foldback beyond 1.5:1.
Harmonics suppression and spurious:	Typically 85 dB
RF power output connector size:	1+5/8" or 3-1/8" with EIA flange

Max. frequency tolerance:	As per ITU (R)
Pilot tone stability:	As per ITU (R)
Ambient temperature range for operation:	0° C to + 45° C
Relative humidity:	95 %, non condensing.
Working altitude:	Up to 3000 meters AMSL *

* For working heights of over 3000 meters, there are (optionally) two possibilities, according to the particular needs of the site:

- extraction fan air
- fans to push the air inside the rack

Typical power consumption of the transmitter:

Transmitter Power (KW)	Phase Current (I _R) Amp.	Phase Current (I _S) Amp.	Phase Current (I _T) Amp.	Neutral Current (I _N) Amp.
1	8	7	7	1
2	10	9	9	1
3	12	11	11	1
4	13	14	13	1
5	14	14	14	1
6	15	15	14	1

Additional important features of the PJ6KPS-CA are as follows:

- The 2.2 kW amplifying modules are implemented by means of plug-in technology: the individual modules may be removed for performing maintenance operations, for instance, without having to turn off the transmitter. The transmitter keeps working at reduced power even if the module has been removed. This operation may be carried out without any risk of damaging the module itself, or the amplifier as a whole, thanks to the control system and to the RF connectors, the power supply and the purposely designed data-exchange. For further information refer to the maintenance section.
- Each module is controlled by a microprocessor-based card that checks and adjusts its operating mode. The resulting data are transmitted to the control unit.
- The control unit manages the changeover of the two exciters both in automatic and manual mode.
- The amplifier can work as usual even if the control unit is not present. In fact, the control unit may be substituted temporarily with an electromechanical interface by means of which the user may give the ON and OFF commands to the transmitter. However, in this case all the numeric type information will be missing and the power level remains the last one enabled before removing the control unit.
- Immediate power foldback under severe / damaging fault conditions of VSWR. The power of transmitter should automatically come down to a suitable safe design limit, so that the transmitter and its subsystem does not get damaged due to load mis match.

The foldback function, on the VSWR protection, works automatically on bias voltage and PA voltage, reducing them to ensure that the transmitter can work at maximum power, not to damage internal organs (mosfet, combiners and rejected load).

4.4 Operating principles

This description is based on the block diagram shown in Figure 4-1.

The PJ6KPS-CA amplifier essentially comprises of two blocks:

- The Splitter-Coupler section
- The RF amplifier section

The Splitter-Coupler section performs all the treatment of the RF signal except for the power amplification.

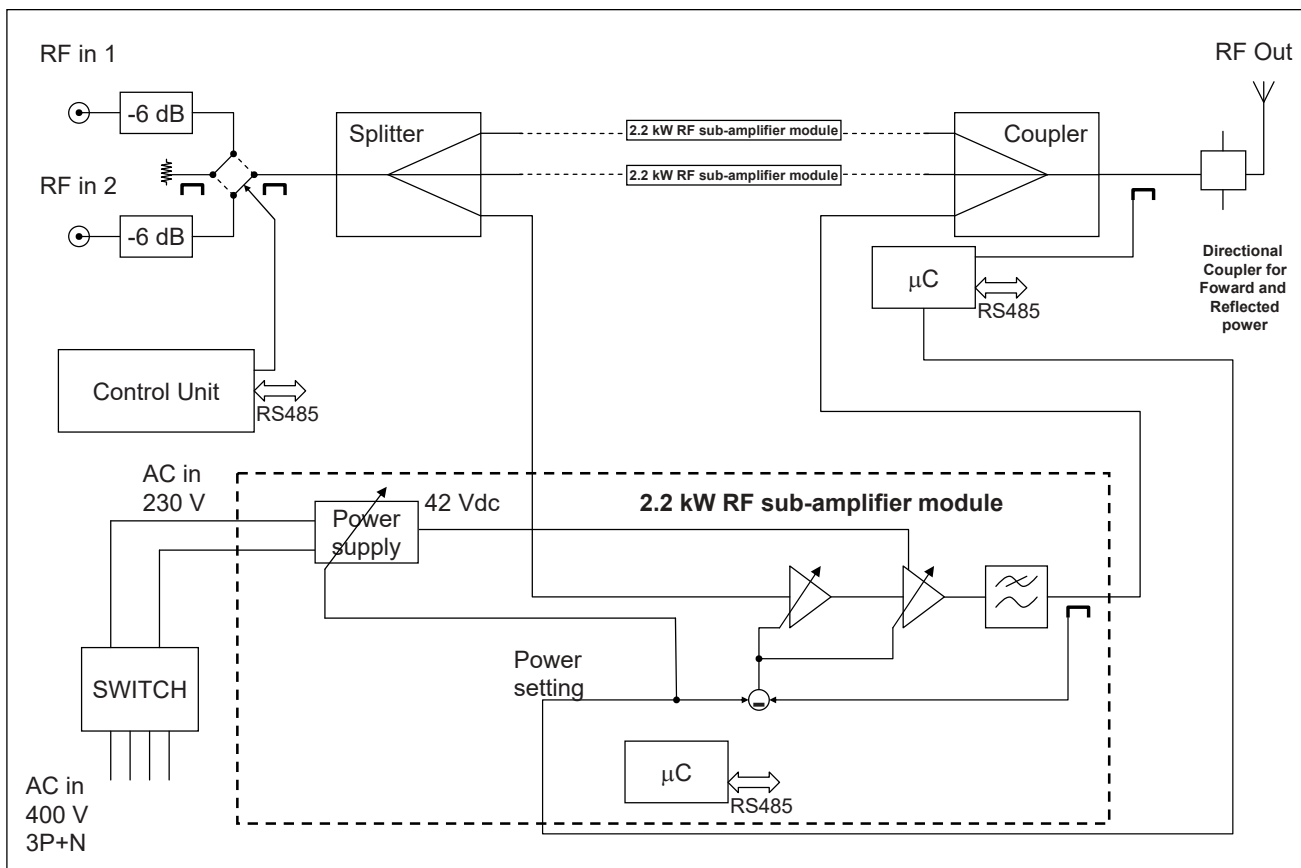

Figure 4-1 Block diagram of PJ6KPS-CA

The RF signals generated by two exciters (in the redundant configuration) are first attenuated by 6 dB to improve the uncoupling among the stages and then connected to a coaxial relay commanded by the control unit. One of the two signals is closed on a reject load built into the transmitter whereas the other signal is connected to the input splitter. The power of both signals is measured by specific directional couplers.

The RF signal of the selected exciter is divided into three branches, each of which is passed to the input of an amplifying module.

The three RF amplifiers branches are recombined by the coupler at the output of the amplifying modules. The overall amplified RF signal is filtered by a low-pass filter for eliminating the harmonics and is therefore available at the output connector.

The Splitter-Coupler section is controlled by a microprocessor-based card, which makes the values detected at the various measuring points available for the user and for the diagnostics functions.

The system contains three RF sub-amplifier modules each of which is capable of supplying a maximum of 2.2 kW RF and efficiency 80%. Each RF sub-amplifier module incorporate a PFC (Power Factor Corrector) power supply that provides the utmost power efficiency for enhanced energy savings and environmental protection.

Each RF sub-amplifier module contains a first stage with gain that varies (driver) according to the MOSFET MRFE6VS25NR1. The RF signal amplified by the driver is then separated into three branches, amplified by three LDMOS MRFE6VP61K25H or BLF188XR (planar pallet), recombined and filtered by a low-pass filter (Figure 4-2).

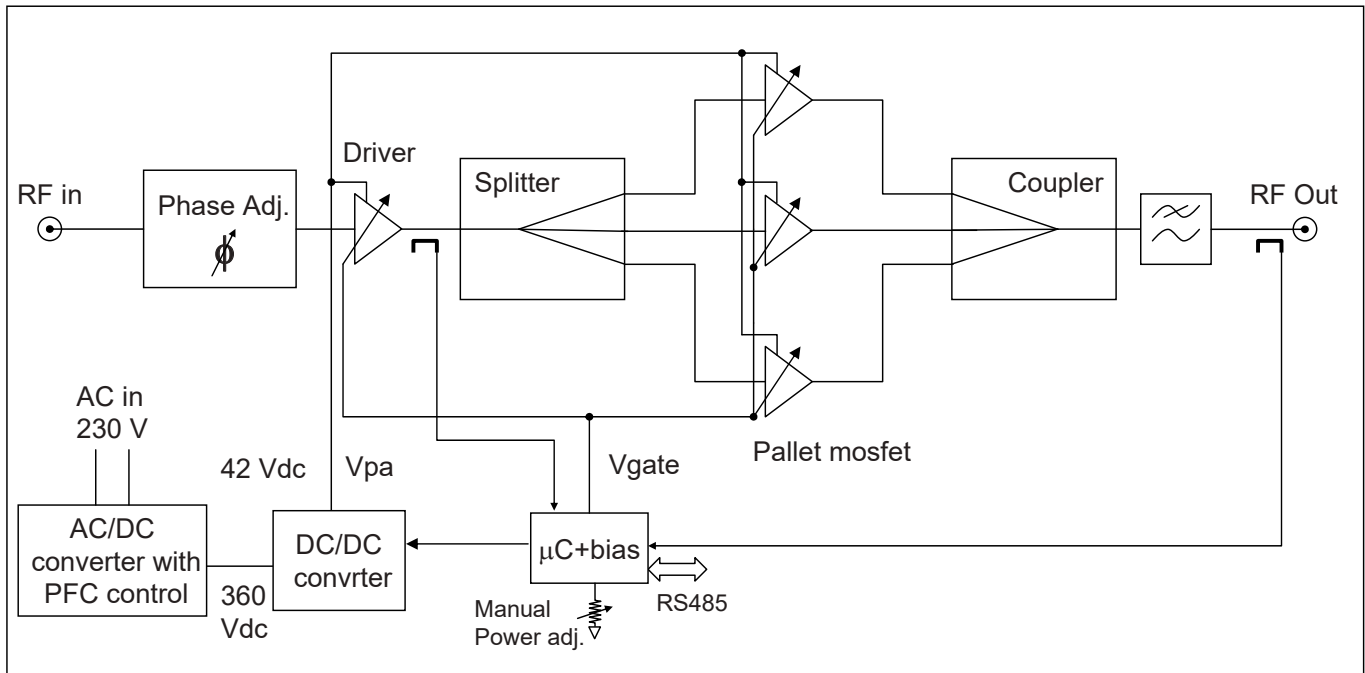

Figure 4-2 Block diagram of RF sub-amplifier module

Each RF sub-amplifier module is controlled by a microprocessor-based card, connected to the other microprocessor-based cards of the system by means of a RS485 type bus.

Each RF sub-amplifier module runs the Automatic Power Control function for regulating the supplied power: the gain of the amplifying stages and the voltage supplied by the switching power supply unit are regulated so that the power that is output from the RF sub-amplifier module corresponds, if possible, to the set level.

The overall power that the PJ6KPS-CA must supply is controlled by the microprocessorbased card of the splitter-combiner section according to the settings made on the control unit for the NOMINAL POWER and LOWER POWER parameters.

4.5 Module failure

In case of failure of one or more modules, as FAULT alarm, the 6 kw transmitter reduces the power and the antenna will have the following signal levels:

Number of PA modules / units failure	Transmitter RF output power in kW
One No.	3.2 kW
Two Nos.	500 W

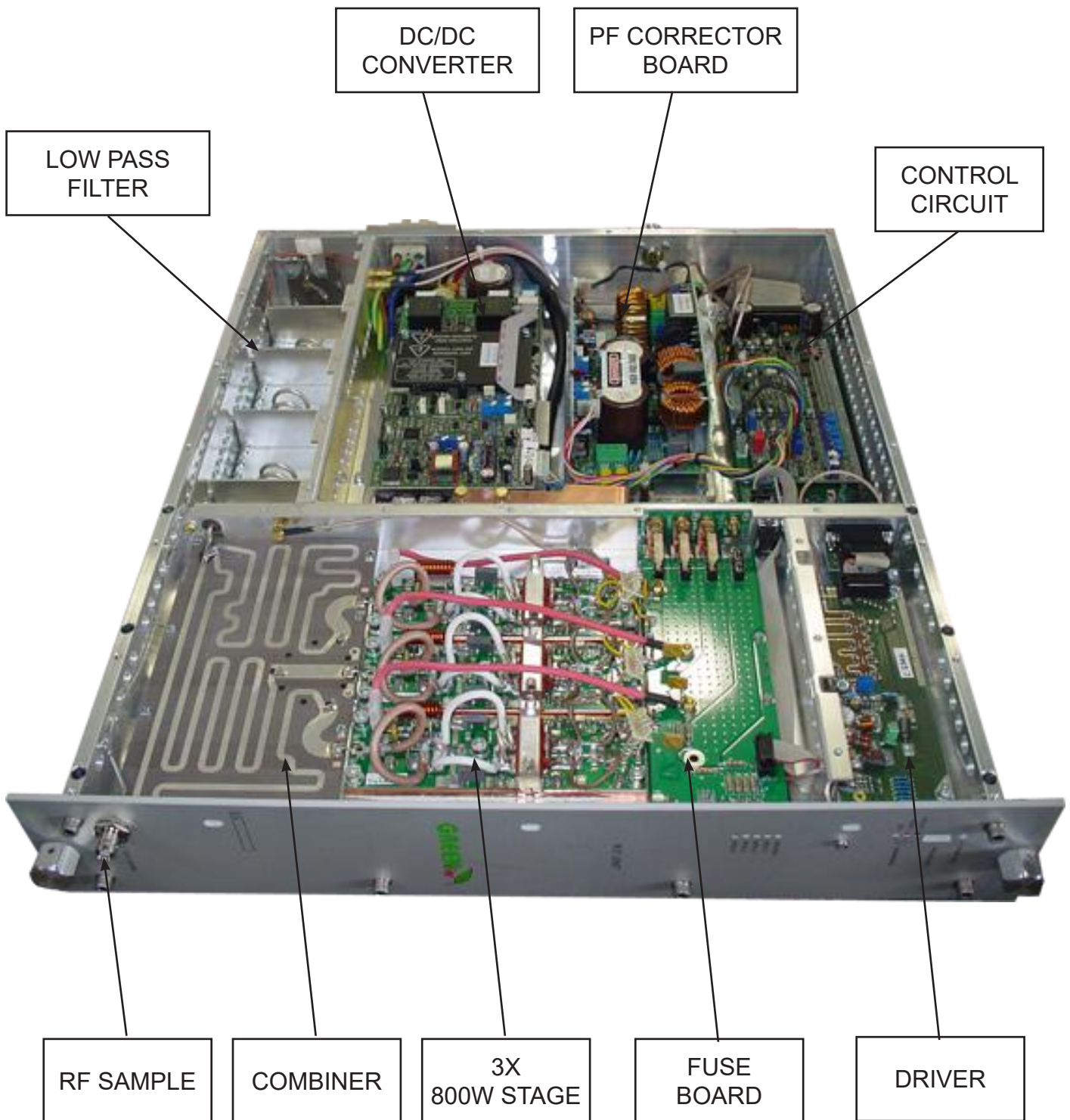

Figure 4-3a Internal view of RF sub-amplifier module (with MRFE6VP61K25H)

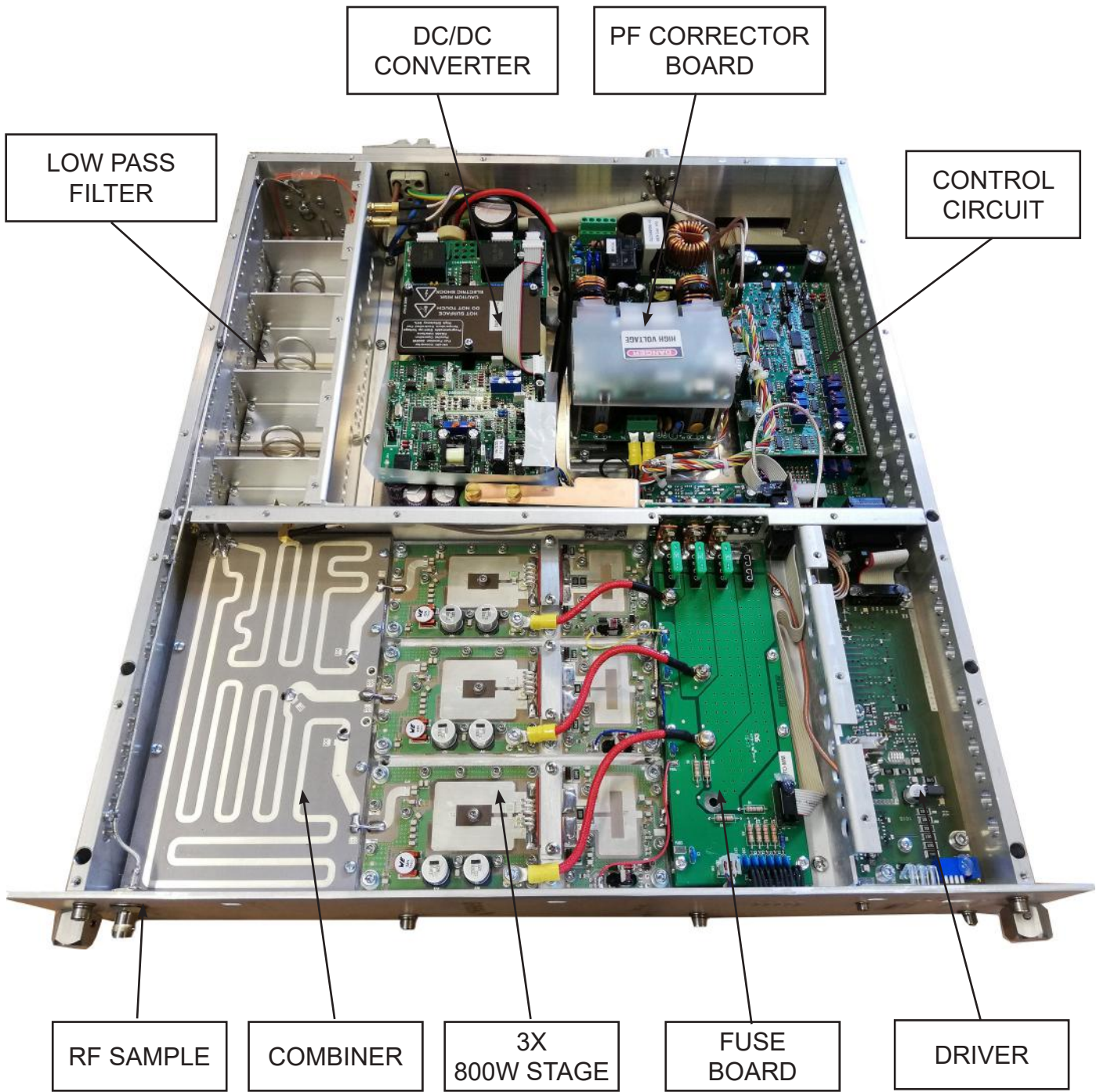

Figure 4-3c Internal view of RF sub-amplifier module (with BLF188XR)

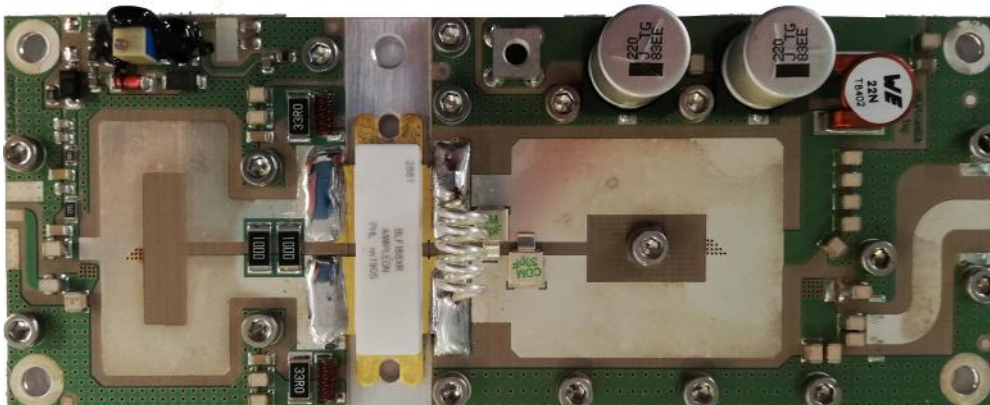
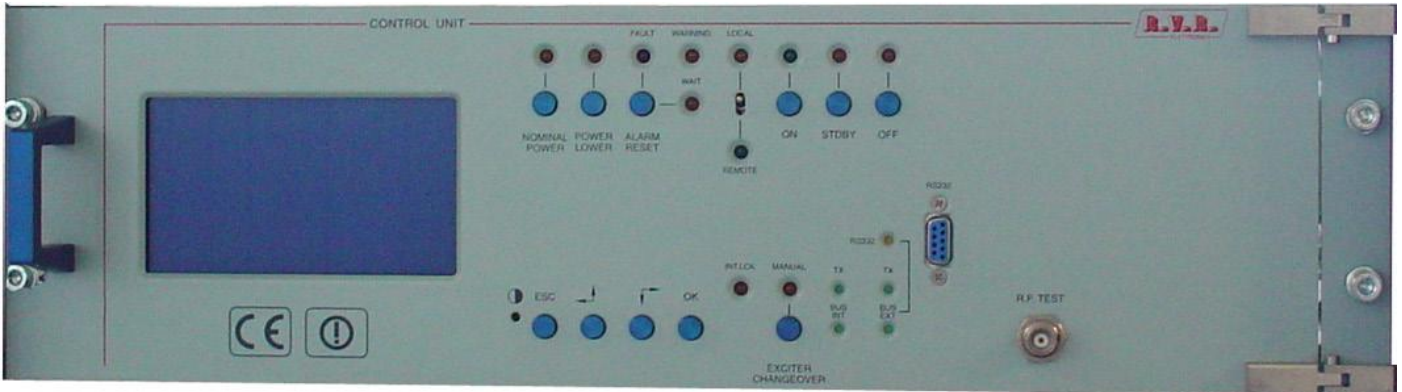

Figure 4-3d Planar pallet (with BLF188XR)

5. Control unit (CU)

The operator controls and checks the status of the PJ6KPS-CA by means of the control unit (CU).



Two control groups are present on this unit:

- LCD and scroll buttons

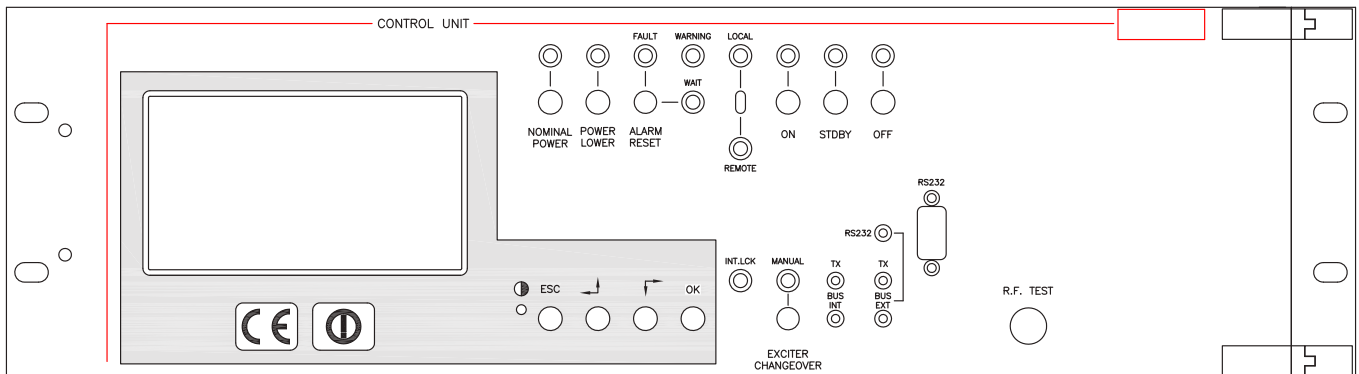

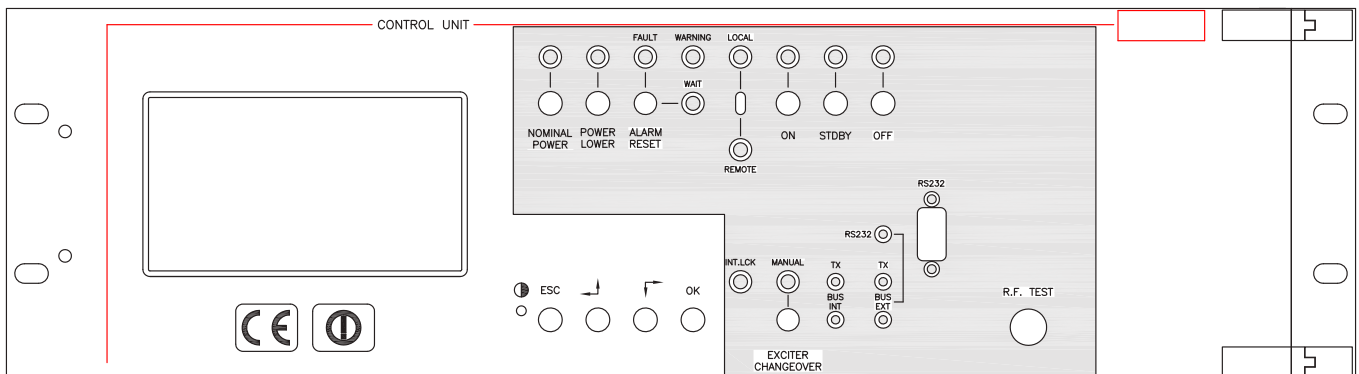

- Buttons, selector switches and LEDs



5.1 LCD Display

The operator uses the control software of the transmitter by means of a series of menus that are displayed on the LCD. Four specific keys are provided for scrolling through the menus, performing the settings and giving the commands:

Button	Description
OK	Click this button to access a sub-menu, to enter the editing mode or to confirm a modified value.
ESC	Click this button to exit from a menu or to cancel the modification of a value.
	Click this button to scroll inside a menu (to the right or down) or to reduce the value of a parameter being modified.
	Click this button to scroll inside a menu (to the left or up) or to increase the value of a parameter being modified.
	Trimmer for the regulation of the contrast of display the LCD

When the operator is not using the various buttons to navigate, the LCD displays the preset screenful that shows the “Output Power” that it indicates the forward and reflected output power (Figure 5-1).

As indicated on the preset screenful, push the ESC button to access at the “Overall Status” menu (Figure 5-2).



Figure 5-1

5.1.1 Overall Status Menu

This menu includes only indications, therefore the user cannot insert any input in its different lines.(Figure 5-2).

Menù Line	Description
Timer (when enabled)	Indication of the start and stop times of the automatic power reduction feature - see “Settings” menù
Control unit	Status of the control unit (Off or On) and indication of the exciter actually connected to the amplifier (Exct.1 or Exct.2)
Power supply	Status of the power supply board
R.F. Combiner	Status of the RF combiner
R.F. Unit - N	Status of the Rf power amplifier number N (1° from the left)
Hours	Timer counting the hours of operation of the transmitter. For example, this indication is useful in order to define when a maintenance operation can be made

By pressing the Esc key as indicated on the last line, you can shift to the exchange screen from which you can have access to the “Select” menu (Figure 5-3).



Figure 5-2

5.1.2 Select menu

This is the exchange menu from which you can select the different sub-menus that compose the software.(Figure 5-3).

In order to enter a sub-menu, select the correspondent line with the arrow buttons and press OK key.

Menu Line	Description
Control unit	General status of the PJ6KPS-CA
Power supply	Status of the power supply board
R.F. Combiner	Status of the RF combiner
R.F. Units	Status of the RF power amplifiers
Alarms	Summary of the occurred alarms
Service	Service menu for the switching on/off of the modules
Settings	Setting of the parameters (i.e. Power levels)
Exciters	Parameters of the exciters (i.e. output power, on air exciter)
Info	Information concerning the configuration of the PJ6KPS-CA
Release	Information concerning the hardware and software versions of the modules composing the unit
Modem	Settings related to the optional telemetry system

To return to the predefined menu press key ESC many times.



Figura 5-3

5.1.3 Control Unit menu

Informative menu on the inputs and the outputs of the CU of the transmitter.(Figure 5-4).

Menu Line	Description
Ext Intl	Input status “external interlock” (JP4/4 parallel interface)
Aux Intl	Input status “auxiliary interlock” (JP4/5)
Exc1 A.Audio	Input status “audio alarm exciter 1” (JP4/8)
Exc2 A.Audio	Input status “audio alarm exciter 2” (JP4/9)
L.P. Timer	Input status of the modality of automatic reduction of the power

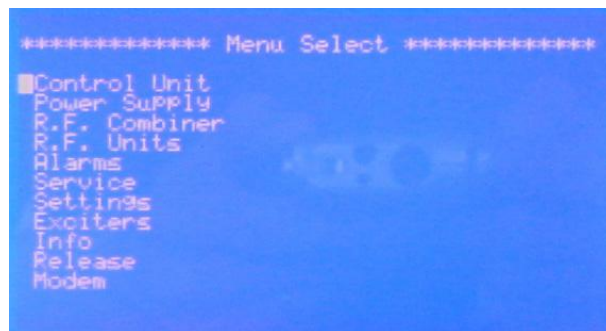
Reserve 2	Input status "Reserve 2" (JP8/3)
Reserve 3	Input status "Reserve 3" (JP8/4)
Reserve 4	Input status "Reserve 4" (JP8/5)
Relay Exc	Exciters exchange relay status (Off = exciter 1 on air)
Exc-1 Mute	Exciter 1 interlock status (Off = RF power enabled)
Exc-2 Mute	Exciter 2 interlock status (Off = RF power enabled)
Audio Alarm	Output Audio Alarm status (JP47/1)
Exc's Mains	Exciters power supply status (On = power supply enabled)
Stand_by (In)	"Stand by" input line status
Stand_by (Out)	"Stand by" output line status from the control unit
Total Eff	Total efficiency of the transmitter

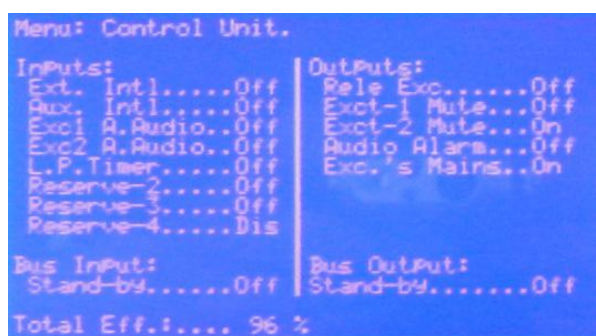

Figure 5-4

5.1.4 Power supply menu

informative menu of PJ6KPS-CA of the transmitter (Figure 5-5).

Menu Line	Description
Bus Fan	Supply voltage of the fans input
Room T	Temperature of the air at the input of the unit
Safety	Status of the safety arrest button. On indicates the functioning is enabled, Alr means the unit was arrested through the button
Mains	Status of the main voltage supply. Ok indicates the presence of all phases and that their sequence is corrected, Alr means that it must verify the presence of all phases, their sequence or the fuse of one or more phases, to protection of the threephase control *
Clk. Blower	Indicates the state of thermostat outlet air
C.B. Pwr. Fan	Indicates the state of motor protection switch input air
C.B. Blower	Indicates the state of motor protection switch output air
Top Blower	Indicates the state of the exhaust fan
K.M.G.	Indicates the status of the contactor general of the transmitter (not used)
Power Fan	Indicates the state of input fan

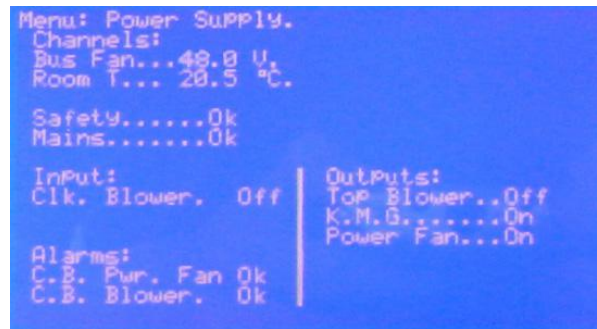

Figure 5-5

* The threephase control and the relative fuses are found on electromechanical section.

5.1.5 R.F. Combiner menu

This menu contains the information related to the RF part of the complete transmitter. (Figure 5-6).

Menu Line	Description
Fwd	Overall emitted RF power of the transmitter
Rfl	Reflected RF power of the antenna
Unbal	Unbalancement RF power: sum of the power dissipated on the internal resistors due to unbalancement in the RF modules
Rej.IT	Temperature of the load resistors dissipating the unbalancement power
Exhaust	Temperature of the exhaust air (top of the transmitter)
S.W.R.	Standing Wave Ratio, calculated by the Control Unit on the basis of the measured forward and reflected power
(External) Fwd	Forward power of an external transmitter (when configured for this function)
(External) Rfl	Reflected power of an external transmitter (when configured for this function)
(External) Unbal	Unbalancement power of an external transmitter (when configured for this function)
Main Exc	Output power of the exciter currently on air (the one connected to the input of the RF modules)
Stby Exc	Output power of the exciter currently on the internal dummy load
Temp	Status of the temperature alarm (sensor included in the combiner)
RF-Enb	RF output enable: "On" means that the RF combiner unit is giving its permission for the regular operation of the transmitter
Aux.Fan	Switch for an auxiliary fan (not used in the current configurations)
SET1	Status of the output "SET1". See the Settings Menu
SET2	Status of the output "SET2". See the Settings Menu
SET3	Status of the output "SET3". See the Settings Menu
SET4	Status of the output "SET4". See the Settings Menu



Figure 5-6

5.1.6 R.F. Units menu

Information menu showing the status of the RF power amplifier modules. (Figure 5-8). It is composed of 3 screens, one for each module, that can be scrolled using the arrow buttons.



Menu Line	Description
Fwd	Measurement of the forward power of the amplifier module
Rfl	Measurement of the reflected power of the amplifier module
Input	Measurement of the driving power at the input of the amplifier module
V.P.A.	Measurement supply voltage of the module (generated from the switching power supply included in each module)
Bias.V	Polarization voltage of the mosfet
Temp	Module temperature
Driver.I	Measurement of the current absorbed by the preamplifier stage
MOS-N (1-3)	Measurement of the current absorbed by the MOS N amplifier module (each RF module contains 3 MOS modules)
Total I	Measurement of the total current absorbed by the RF module
Eff	Efficiency of the amplifier module
(Alarms) Temp	Temperature alarm
(Alarms) PS-Alr	Anomaly in power supply
(Alarms) Unit.Intl	State of the RF module interlock micro-switch
(Alarms) Unbal	Not used
RF-Enb	Enabled of power distribution from part of the module
Fan	Percentage of fan speed of the cooling tray

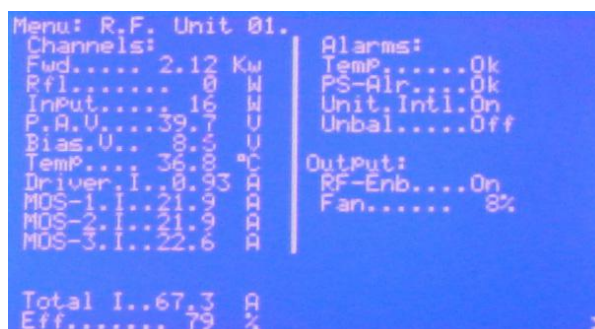

Figure 5-8

5.1.7 Alarms menu

This screen describes all the registered events which are relevant to determine the probable causes of any dysfunction. The screen is composed of a variable number of pages (up to 10) in function of the number of events occurred (Figure 5-9). The last events in chronological order are shown in the first page and so on. To shift to the different pages, use the arrow buttons

You can not delete the alarms displayed, if not employed by RVR

Menu Column	Description
Unit	Module of the system which generated the failure
Err	Type of failure and description. For more information see chapter 5.3
Time	Time (hrs and minutes) at which the failure occurred
Date	Date at which the failure occurred

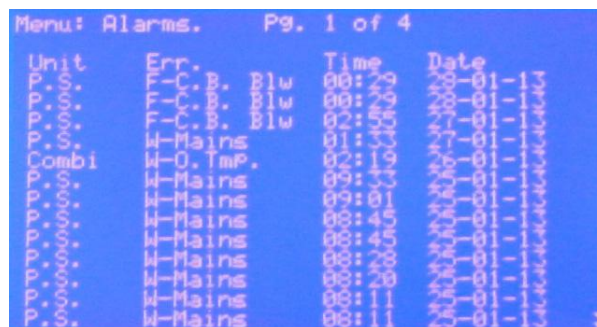

Figure 5-9

5.1.8 Service menu

This menu is normally used during the maintenance operations. When this screen is visualized, the Control Unit checks the status of the modules of the unit more frequently in order to have a visualization of the different parameters as fast as possible. When this menu is entered, all the secondary functions are interrupted, therefore a possible alarm may not be visualized and registered immediately; when exiting this menu all the alarms which were temporarily put in “stand-by” are registered. If the user sets some modules in OFF modality, these will be automatically reactivated when exiting the menu. This menu is deactivated after 60 minutes if no key is selected. (Figure 5-10).

Menu Line	Description
Fwd	Forward power globally emitted by the amplifier
Unb	Unbalancing power dissipated in the dummy load connected to the combiner
RF Unit1 - On	Fields used to switch ON and OFF the amplifier modules.
Fwd	Forward power generated by the RF module
Rfl	Reflect power from the RF module

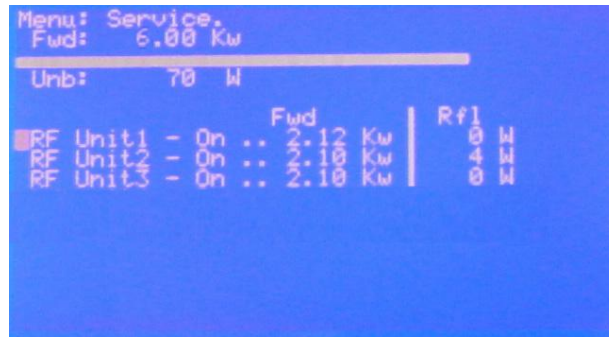

Figure 5-10

5.1.9 Settings menu

This menu is used for the settings of the unit. It is therefore the menu which is used more often apart from the possible maintenance operations.(Figure 5-11).

Menu Line	Description
Nominal Pwr	Setting of the level of nominal power, expressed as a percentage of the maximum power level. This is the level that the PJ6KPS-CA must reach when the Power Nominal button is pressed, except in case of dysfunction
Low Power	Setting of the reduced power level, expressed as a percentage of the maximum power level. This is the level that the PJ6KPS-CA must reach when the Power Lower button is pressed, except in case of dysfunction.
SET1	Level (Limit) at which the first “Power Good” level SET1 is launched. This level is expressed as a percentage of the full-scale to which SET1 is connected, indicated in the column Assign
SET2	Level (Limit) at which the second “Power Good” level SET2 is launched. This level is expressed as a percentage of the full-scale to which SET2 is connected, indicated in the column Assign
SET3	Level (Limit) at which the first “Reflected power” level SET3 is launched. This level is expressed as a percentage of the full-scale to which SET3 is connected, indicated in the column Assign
SET4	Level (Limit) at which the second “Reflected power” level SET4 is launched. This level is expressed as a percentage of the full-scale to which SET4 is connected, indicated in the column Assign
Exc' wait time	Delay before assuming the on air exciter is faulty
Talk Address	Address of the unit in the RS485 network
Time	Visualization and setting of the internal clock of the unit
Date	Visualization and setting of the internal calendar of the unit
L.P. Timer	Setting of the automatic power reduction feature: this can be “Auto” (enabled) or “Manual” (disabled). The feature consists in reducing the power to the low power level and then returning to the nominal power at fixed times. The start and stop times are set in this menu selecting “Auto”.
Write Config	Button for the registration of the configurations in each module of the unit.



Figure 5-11

5.1.10 Exciters menu

This menu is used to configure the settings of the exciters (Figure 5-12).

Menu Line	Description
Main Exc	Output power of the exciter currently on air
Stdby Exc	Output power of the exciter currently on the internal dummy load
Main Exciter	Visualization of the “on air” exciter. When positioning the cursor on this line, with the arrow buttons and by pressing Enter, it is possible to operate the switching between the on air exciter and the exciter on dummy load.
Exct.1	Status of the exciter 1. By positioning the cursor on this line with the arrow buttons and by pressing Enter it is possible to switch on and off the exciter.
Exct.2	Same as Exct.1 for the second exciter

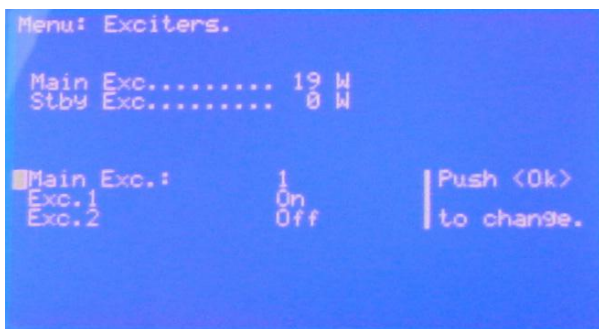

Figure 5-12



Note: the exchange of the exciter and the relative cursor are available only if the logic of exchange is set to manual and the yellow LED is lit.

5.1.11 Info menu

This screen informs the user about the configuration of the transmitter. (Figure 5-13).

Menu Line	Description
S.N.	Serial number of the transmitter
Talk Addr.	Address of the RS485 port of the transmitter, it must be obligatorily 3
Baud Rate	Baud rate of the serial port
Software V.	Software version installed in the CU
Exciter	Number of the exciters in the transmitter: this can be "Single" or "Dual"
Cfg. N+1	Configuration of the transmitter as a N+1 system
External	Checking of the external Fwd, Rfl, Unbal values (Enabled or Disabled)
Reset Safety	Reboot the transmitter after the intervention of the SAFETY alarm. It must always be "Auto"
Polarization	The transmitter is designed to be able to transmit in the future, even with digital signals. To do this we need to change parameters on both the tensions of active devices, both on the readings of the parameters. Activating the "Analog", the transmitter operates in classic analog configuration, putting "Digital" can process and transmit the digital signals.



Figure 5-13

5.1.12 Release menu

This menu is composed of 2 screens, that can be scrolled using the arrow buttons. The first show the address, the kind of configuration, the software version and the hardware version of all the microprocessor boards of the transmitter (Figure 5-14), the second shows the serial numbers of the modules (Figure 5-14a).



Menu Line	Description
Control unit	Information on the CU
Power supply	Information on the power supply
RF Combiner	Information of the RF combiner
RF Unit 1	Information on module 1
RF Unit 2	Information on module 2
RF Unit 3	Information on module 3

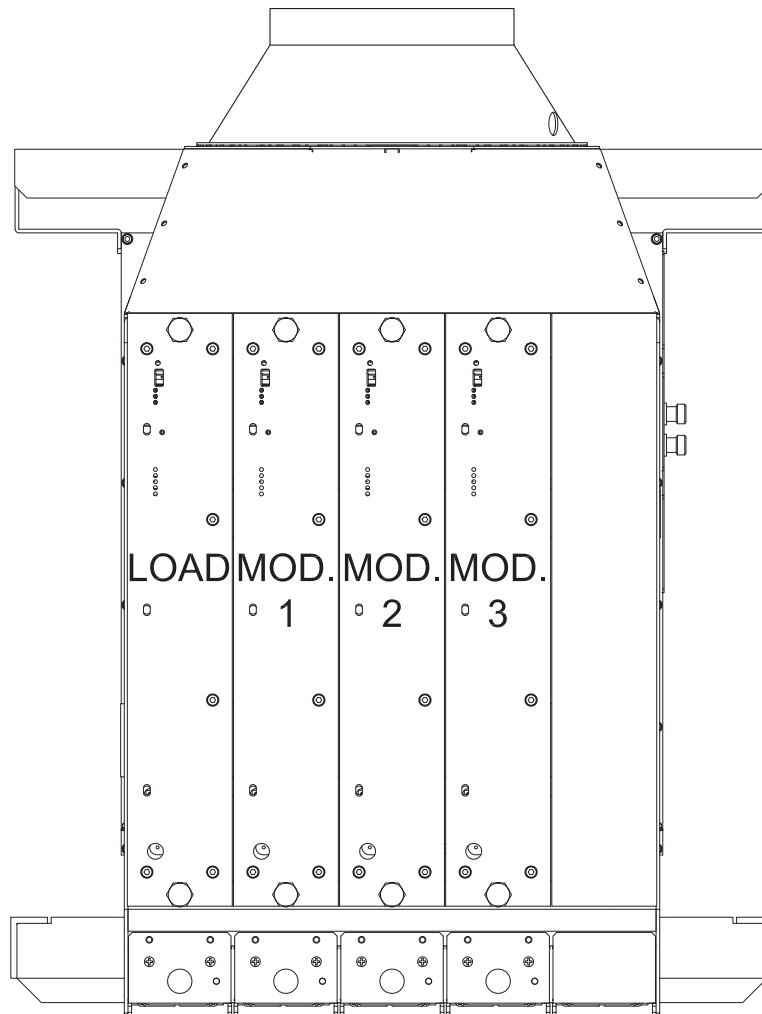

Menu Line	Description
S.N. -1	Year of production of the module
S.N. -2	Serial number of the module

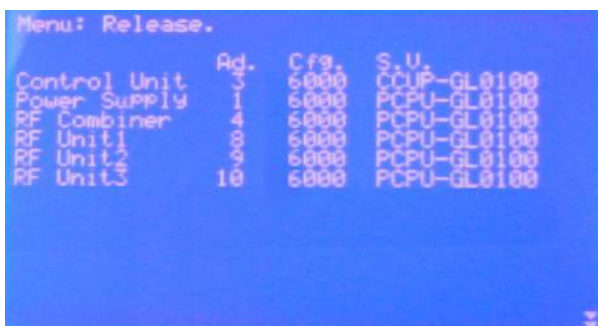

Figure 5-14

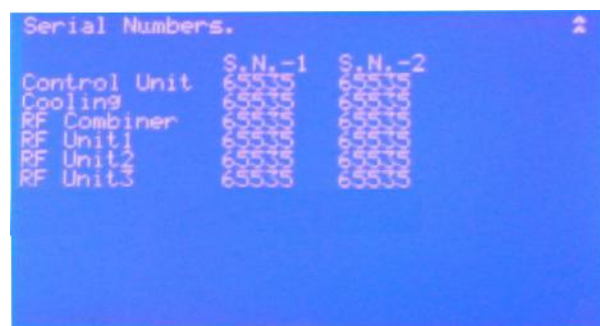

Figure 5-14a

5.1.13 Modem menu

This screen informs the user about the configuration of the optional telemetry GSM (Figure 5-15). The parameters on this screen can be displayed only if the selector switch on the CU is located at a REMOTE location, if it is placed in the LOCAL screen appears as in Figure 5-15a. If you have not installed the telemetry box, the screen will appear the figure 5-15b.

Menu Line	Description
I.D.	Identification of the address of the transmitter, usually 1. In the case of multiple transmitters in N +1 configuration will be given numbers in ascending order, one for each transmitter
Name	Mnemonic name of the station, like place or frequency
S.C.N	Service center number of your mobile operator
Info	Name of service provider
Dial	Normally, ATDT
Phone	Phone numbers that will receive the alert messages
Level	GSM signal level
Status	State Modem
Retry	Number of messages to send. We suggest to set this value to at least 2, in case of problems with the SMS Service Centre.
Type	Modem type, usually GSM

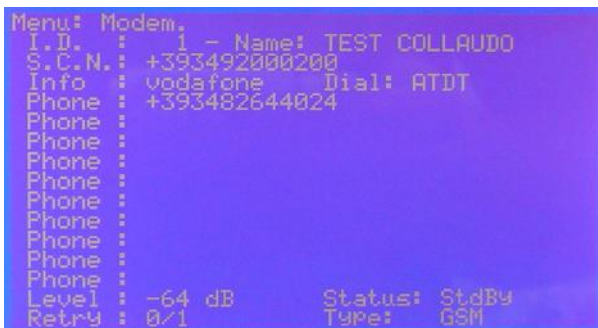

Figure 5-15



Figure 5-15a

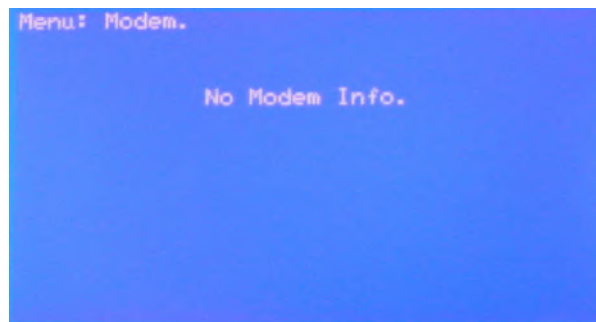

Figure 5-15b

5.2 Buttons, selector switches and LEDs

The typical transmitter-control operations are performed using the buttons of the control unit’s panel. Specific LEDs correspond to each button and selector switch for indicating the transmitter’s status.(Figure 5-16).



Figure 5-16

The functions performed by the controls are as follows:

Function	Description
OFF	Button for turning off the transmitter. A LED signals that the transmitter is OFF. In this status, the exciters and the blower, are off.
STDBY	Button for setting the transmitter in standby. In this status the transmitter does not emit any power, but is ready to start the transmission: the main blower is on, the RF modules are not powered, the exciters are on but locked by means of an interlock. The stand-by is used to test the exciters, in fact in manual modality the operator could arrange them in base to the own requirements; coming from an “On” in manual modality, the system does not touch the interlock. Stand-by status is signalled from a LED. In manual and in stand-by the inhibit of the device doesn’t intervene on the interlock of the exciters. This could necessary when the transmitter is in configuration n+1 for verify if the exciters are operational.
ON	Button for turning on the transmitter. The RF power supply is activated. If the command is set to MANUAL CHANGEOVER EXCITER (led on), exciters will block interlock and have to go through in “exciters menu” of CU to enable them manually. The exciters should deliver a power of at least 15 W to start the transmitter.

LOC/REM	Selector switch for setting the transmitter in remote or local mode. In local mode the buttons and the controls via the menus are active. In remote mode the buttons and the controls via the menus are inhibited and the commands may be given only remotely via the parallel interface or via the remote control software.
ALARM RESET	Button to reset the alarm type FAULT or WARNING.
POWER LOWER	Click this button to set the transmitter for supplying the nominal power level. A specific LED signals this setting. The value that corresponds to the nominal level is set by the operator using the menu settings (see 5.1.9)
NOMINAL POWER	Click this button to set the transmitter for supplying the reduced power level. A specific LED signals this setting. The value that corresponds to the reduced level is set by the operator using the menus. (see 5.1.9)
EXCITER CHANGEOVER	Use this button to set the changeover system in manual or automatic mode. The signaling LED turns on when the manual mode is selected. On performing a changeover, the exciter connected to the amplifier is deviated toward the internal dummy load and vice-versa. The operator must use the exciter menu to perform the changeover in manual mode.
LED WARNING	This LED indicates an attention condition (something is not working properly, but the amplifier is still running)
LED FAULT	This LED indicates a fault (the amplifier is blocked, and required the intervention of an operator for the restoration)
LED WAIT	This LED indicates the status of waiting (the amplifier is temporarily disabled, but will be reactivated automatically when the blockage is removed, or after a set period of time depending on the type of protection)
LED INT.LCK	This LED indicates an external inhibition. This check is run on the parallel interface (JP4/4)
LED TX-BUS INT	These LEDs indicate the activity of the serial bus 485 through which the CU acquires the status every second of the modules
LED RS-232 TX-BUS EXT	These LEDs indicate the communication between the CU and a PC connected to the RS-232

5.3 Alarms

The menu Alarms of the control unit reports all the events connected to possible malfunctioning of the equipment or due to external causes.

Each registration contains the reference to the concerned module, the kind of event and its date and hour.

The module that detected the event is indicated by one of the following acronyms:

- C.U. (Control Unit)
- P.S. (Power supply)
- R.F. X (RF module number X - from 1 to 3)
- Combi (Combiner/Splitter)

The type of event allows to identify the origin and the consequence of the fault. The first letter of the type of event can be one of the following:

- W “Wait” event that causes the temporary block of the piece of equipment that will be removed as soon as the problem is solved.
- R “Retry”, event that causes a temporary block of the piece of equipment, that will effect a restart attempt after a fixed lapse of time. (Max. 8 attempts)
- F “Fault”, event that causes the block of the equipment and requires the intervention of an operator for the restart.
- E “Error”, event that doesn’t cause the interruption of the supply of power, but can reduce the functions of the equipment (e.g cannot be done the changeover function of the exciters)

The possible event types are listed in the table below.

Code	Meaning
Control Unit	
-E.Intl	external interlock
-A.Intl	auxiliary interlock
-Audio-1	audio alarm of exciter 1 is active
-Audio-2	audio alarm of exciter 2 is active
-L.P.Tmr.	Low power timer active
-Ris-2	reserve 2 input is active
-Ris-3	reserve 3 input is active
-Ris-4	reserve 4 input is active
-Mute Flt	“Mute fault”: the mute commands (i.e. the interlock commands for the exciters) are not working, they are not connected or the connection is wrong
-Xchg Exc	a changeover of the exciters has been performed
-Cfg. N+1	The transmitter is in Fault status because three changeover attempts have been performed (N+1 configuration)
Power Supply	
-Tmp.	the air inlet temperature is too high
-Mains	the phase sequence is not correct
-C.B. Top	The circuit breaker of the air extractor motor blocked it
-C.B. Blw	The circuit breaker of the blowers transformer blocked it

Combiner	
-Fwd	forward power above its limit
-Rfl	reflected power above its limit
-O.dvr In	overdrive (main exciter)
-O.dvr Ld	Too much power dissipated on the internal dummy load (stand by exciter)
-Unbal	Unbalancement power above its limit
-Rej.I.T	Overheating of the unbalancement (rejection) load resistors
-Exhaust	Exhaust overheating
-S.W.R.	SWR above its limit
-Ext.Alr.	external alarm for future use
R.F. Unit	
-Fwd	forward power alarm module
-Rfl	reflected power alarm module
-In	alarm input power module
-Tmp.	high temperature alarm
-Drv. I	driver current above its limit
-Mos 1 I	high current alarm mos1
-Mos 2 I	high current alarm mos2
-Mos 3 I	high current alarm mos3
-Eff.	efficiency too low
-PS-Alr	the power supply is not supplied or is broken
-O.Tmp.	overheating on the module's heatsink
-Unbal	unbalancement power above its limit
General	
-Replay err.	wrong answer by the module interrogated
-Safety	emergency button pressed
Time-out	the module does not respond
Default Talk Address: 31	default address for configuration
Device not configured	control unit is not configured
Waiting for Retry: xxxx sec.	to reset the pause time, press ok
Start Up in Progress	starting up
Please Wait	please wait.....

6. Details principal, Components and Sub-Systems

FRONT VIEW

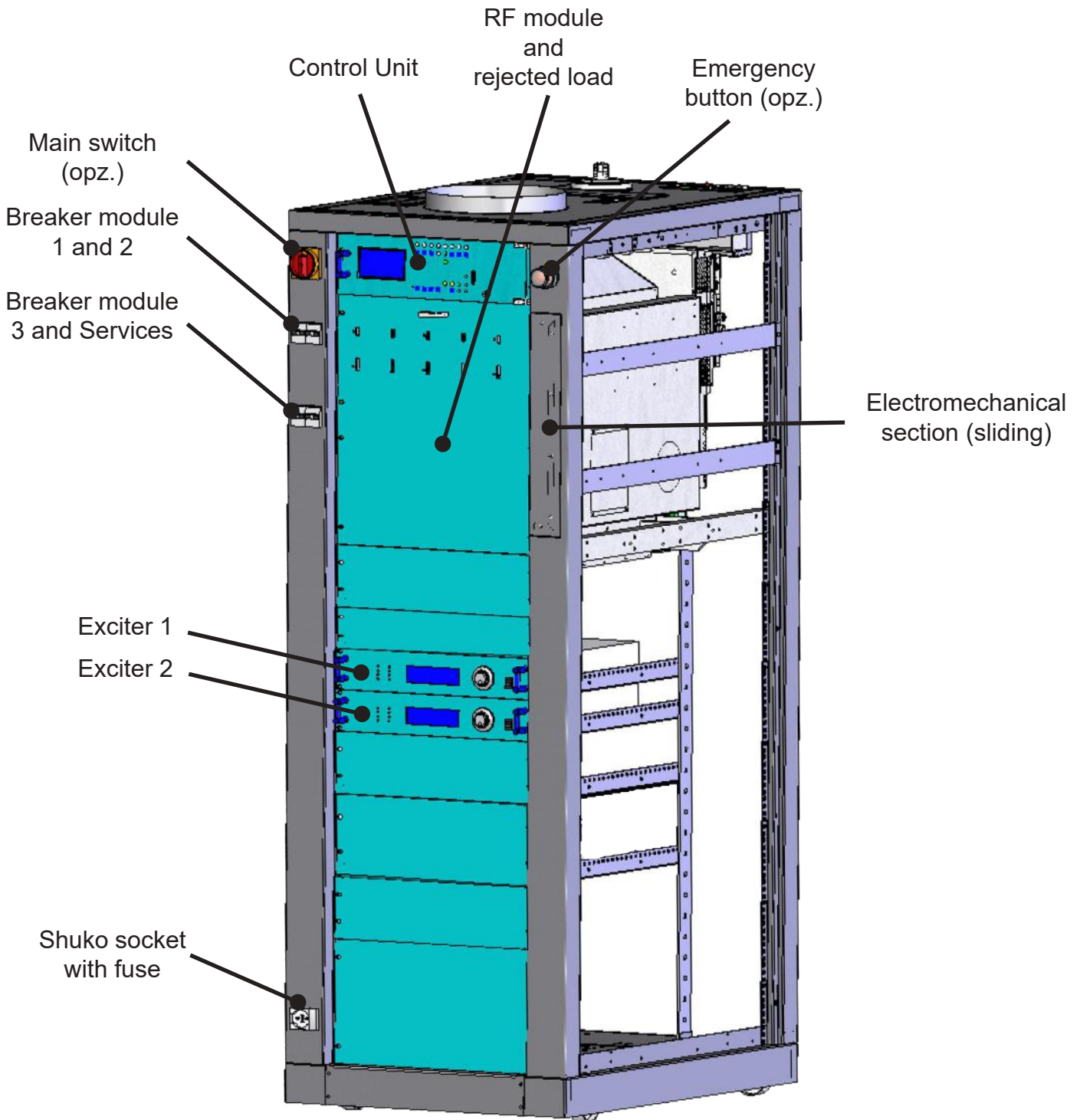

REAR-SIDE VIEW

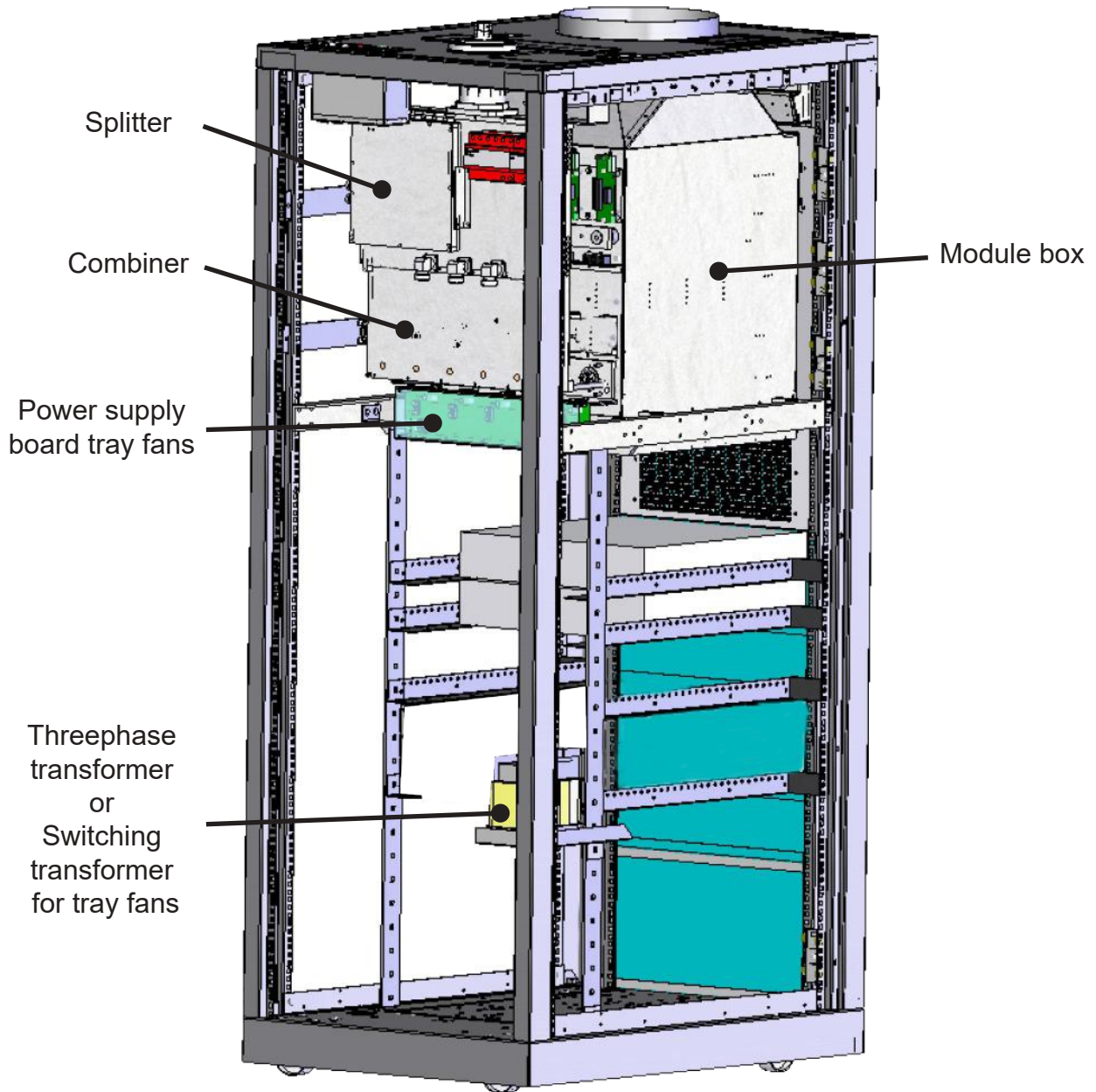

TOP VIEW

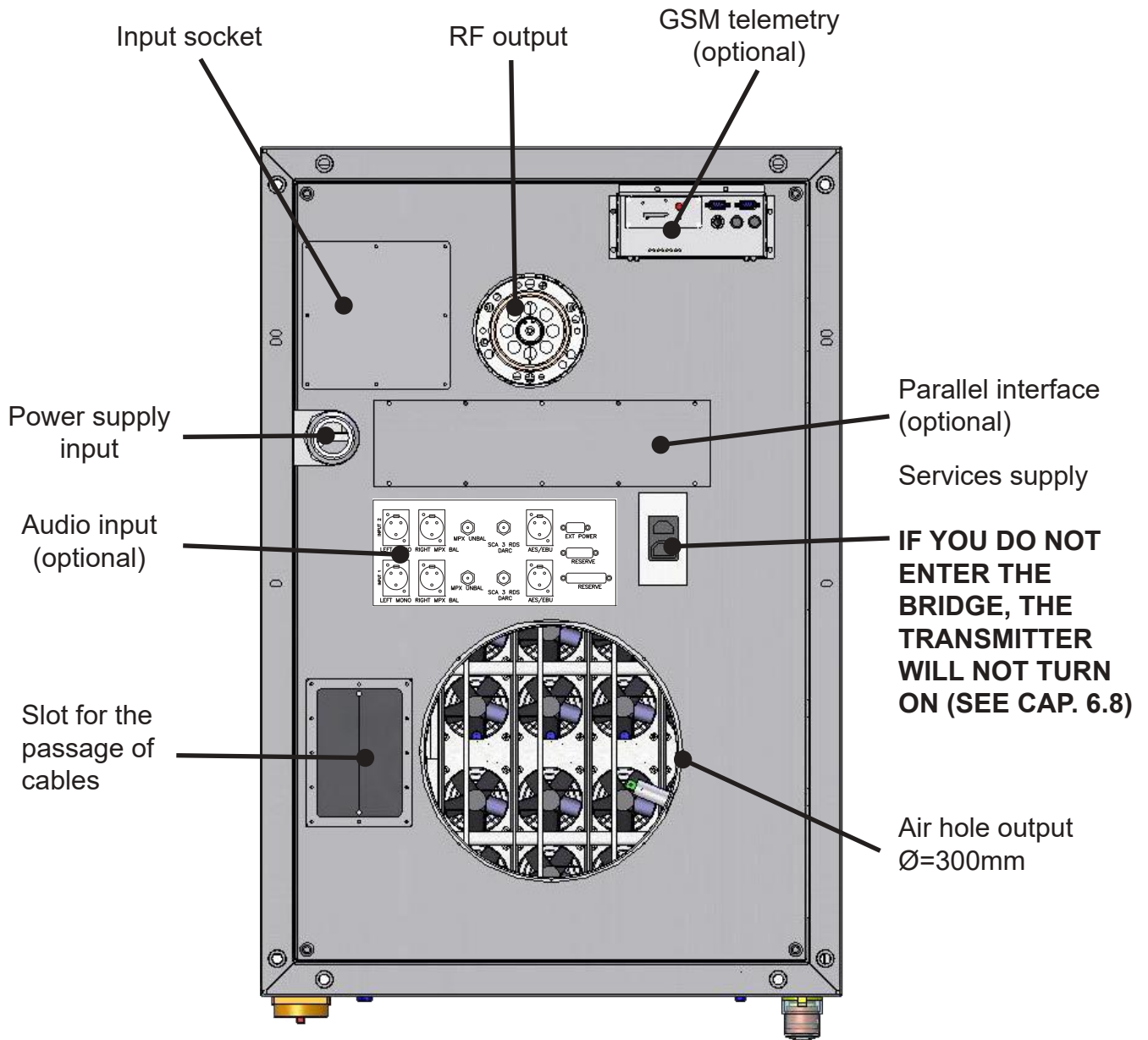

6.1 Control unit (CU)

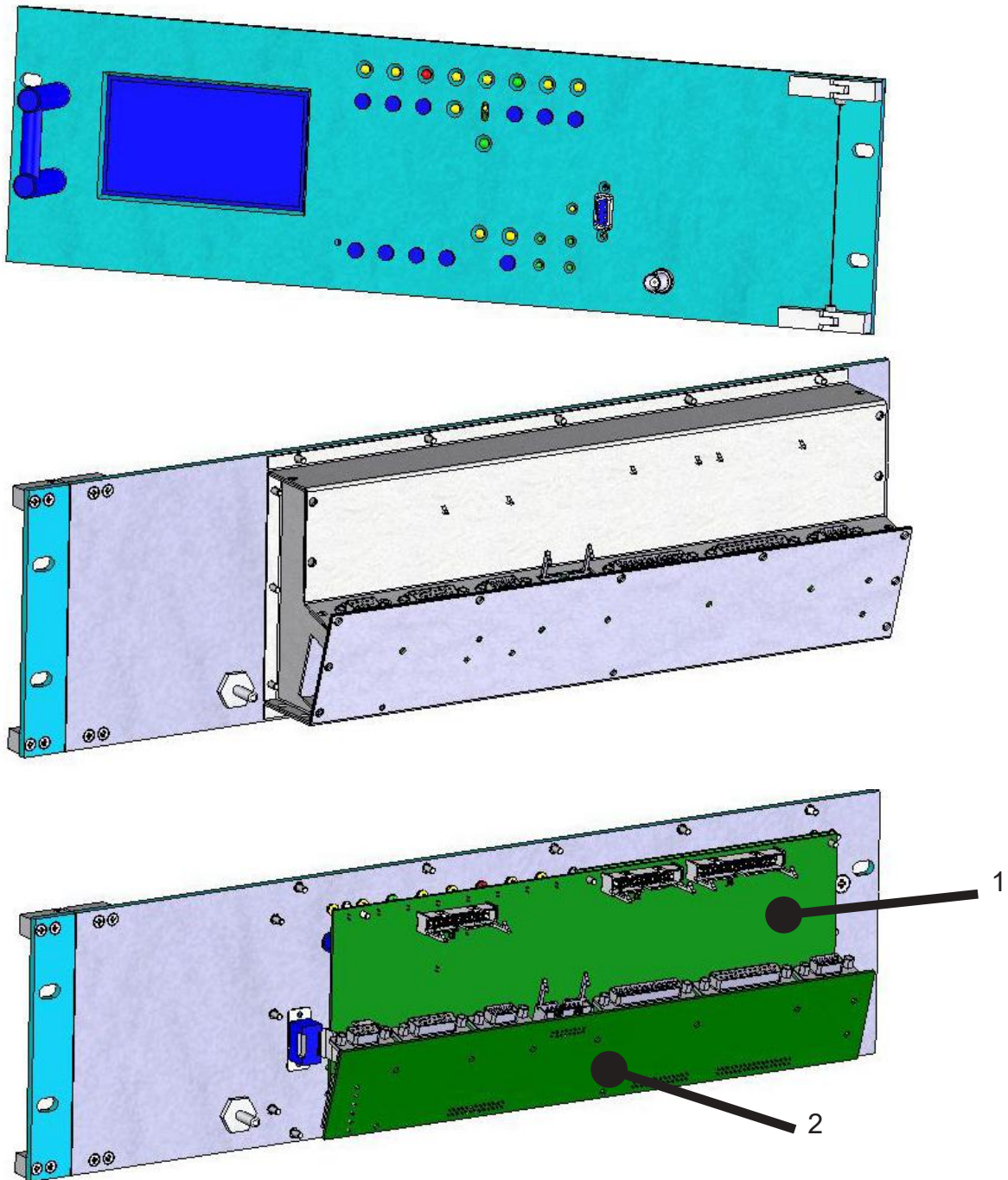

N°	Description	Code	Technical annex page
1	Core control unit	SLCCUPJ5KM4	1
2	Motherboard control unit	SLCCU1PJ5KM3	6

6.1.1 Settings Motherboard control unit

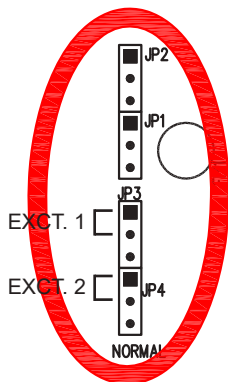
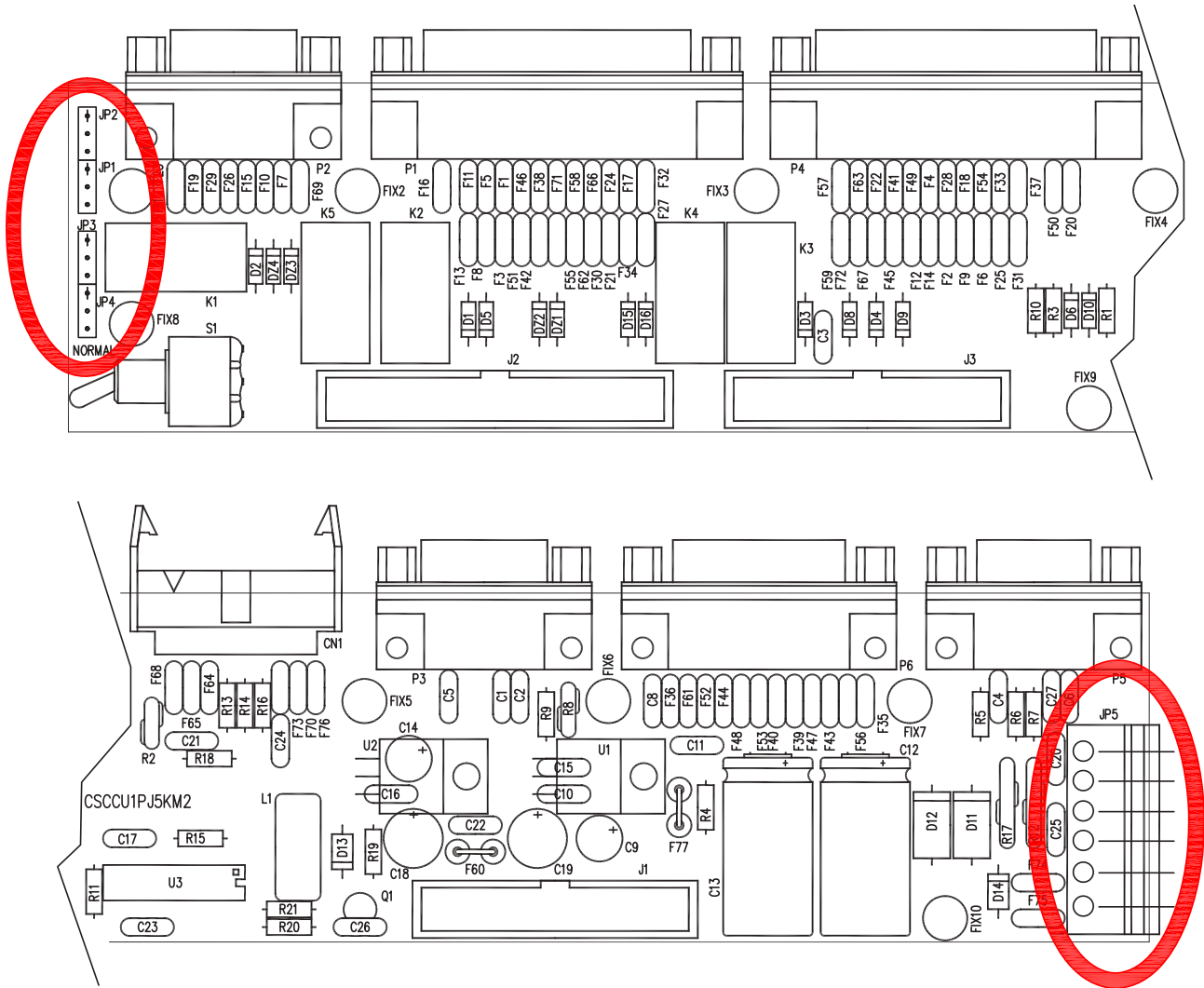

Leaving the jumpers as shown in the figure, the audio alarm is active, that is, when the audio is no longer present at the exciter, at the time of on air, the system automatically switches on the other exciter. Removing the jumpers the audio alarm is disabled. We must also disable the control “Expwr” on the related modulator, to do this must be removed from the connector JP8 of panel card (located in the front of the PTX-LCD), the “Jump 4” if the modulator mounts the CPU 8-bit, instead you have to remove the “Jump 5” if the modulator is equipped with the 16-bit CPU.

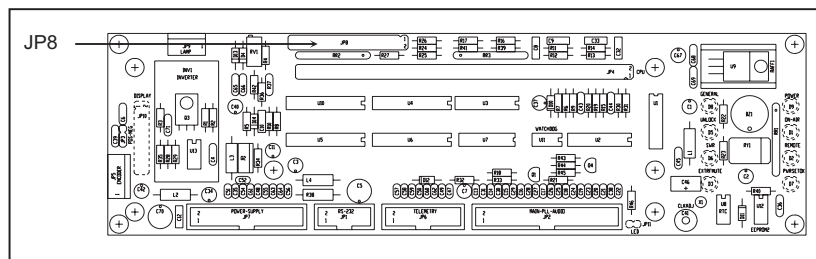

Panel card

Meaning Jump JP8 with 8-bit CPU

JP8 Position of panel card jumpers.

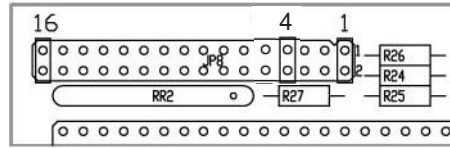

The software denotes jumper positions as follows (1 signifies a closed jumper, 0 open jumper, X any position):

Jump 4	Jump 5	Jump 6	Jump 7	Jump 8	Meaning
0	0	X	X	X	ExpPwr, ExSts and ExFrq menu disabled
1	0	X	X	X	ExpPwr and ExSts menu enabled, ExFrq menu disabled
0	1	X	X	X	ExpPwr and ExSts menu disabled, ExFrq enabled
1	1	X	X	X	ExpPwr, ExSts and ExFrq disabled
X	X	0	0	0	Default parameters set in case of exciter reset: CCIR for PLL at 10MHz
X	X	1	0	0	Default parameters set in case of exciter reset: FCC
X	X	0	1	0	Default parameters set in case of exciter reset: OIRT
X	X	1	1	0	Default parameters set in case of exciter reset: Japan
X	X	0	0	1	Default parameters set in case of exciter reset: Italy
X	X	1	0	1	Default parameters set in case of exciter reset: CSI
X	X	0	1	1	Default parameters set in case of exciter reset: China
X	X	1	1	1	Reserved for future applications

Meaning Jump JP8 with 16-bit CPU

JP8 Position of panel card jumpers.

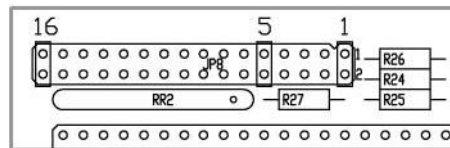

The software denotes jumper positions as follows (1 signifies a closed jumper, 0 open jumper, X any position):

Jump 5	Jump 6	Jump 7	Jump 8	Jump 9	Jump 10	Jump 11	Jump 12	Jump 13	Jump 14	Meaning
0	0	X	X	X	X	X	X	X	X	ExpPwr, ExSts and ExFrq menu disabled
1	0	X	X	X	X	X	X	X	X	ExpPwr and ExSts menu enabled, ExFrq menu disabled
0	1	X	X	X	X	X	X	X	X	ExpPwr and ExSts menu disabled, ExFrq enabled
1	1	X	X	X	X	X	X	X	X	ExpPwr, ExSts and ExFrq disabled
X	X	0	0	0	X	X	X	X	X	Default parameters set in case of exciter reset: CCIR for PLL at 10MHz
X	X	1	0	0	X	X	X	X	X	Default parameters set in case of exciter reset: FCC
X	X	0	1	0	X	X	X	X	X	Default parameters set in case of exciter reset: OIRT
X	X	1	1	0	X	X	X	X	X	Default parameters set in case of exciter reset: Japan
X	X	0	0	1	X	X	X	X	X	Default parameters set in case of exciter reset: Italia
X	X	1	0	1	X	X	X	X	X	Default parameters set in case of exciter reset: CSI
X	X	0	1	1	X	X	X	X	X	Reserved for future applications
X	X	1	1	1	X	X	X	X	X	Reserved for future applications
X	X	X	X	X	1	X	X	X	X	MAINS alarm enabling. NOTE: in this case is necessary to move the two jumpers from positions 3-5 and 4-6 to the positions 1-3 and 2-4, of Supply card JP6 jumper(see fig. below)
X	X	X	X	X	X	1	X	X	X	TRDSP optional card presence
X	X	X	X	X	X	X	1	X	X	13 MHz Quartz frequency on PLL card
X	X	X	X	X	X	X	X	1	X	Telemetry optional card presence
X	X	X	X	X	X	X	X	X	1	SFN software version (only for TRDSP)

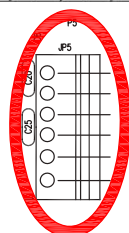

AC 18V
GND
GND
AC 18V
- RELE
+ RELE

Power supply pinout

6.2 RF module (PF1RF2KPJ5KM)

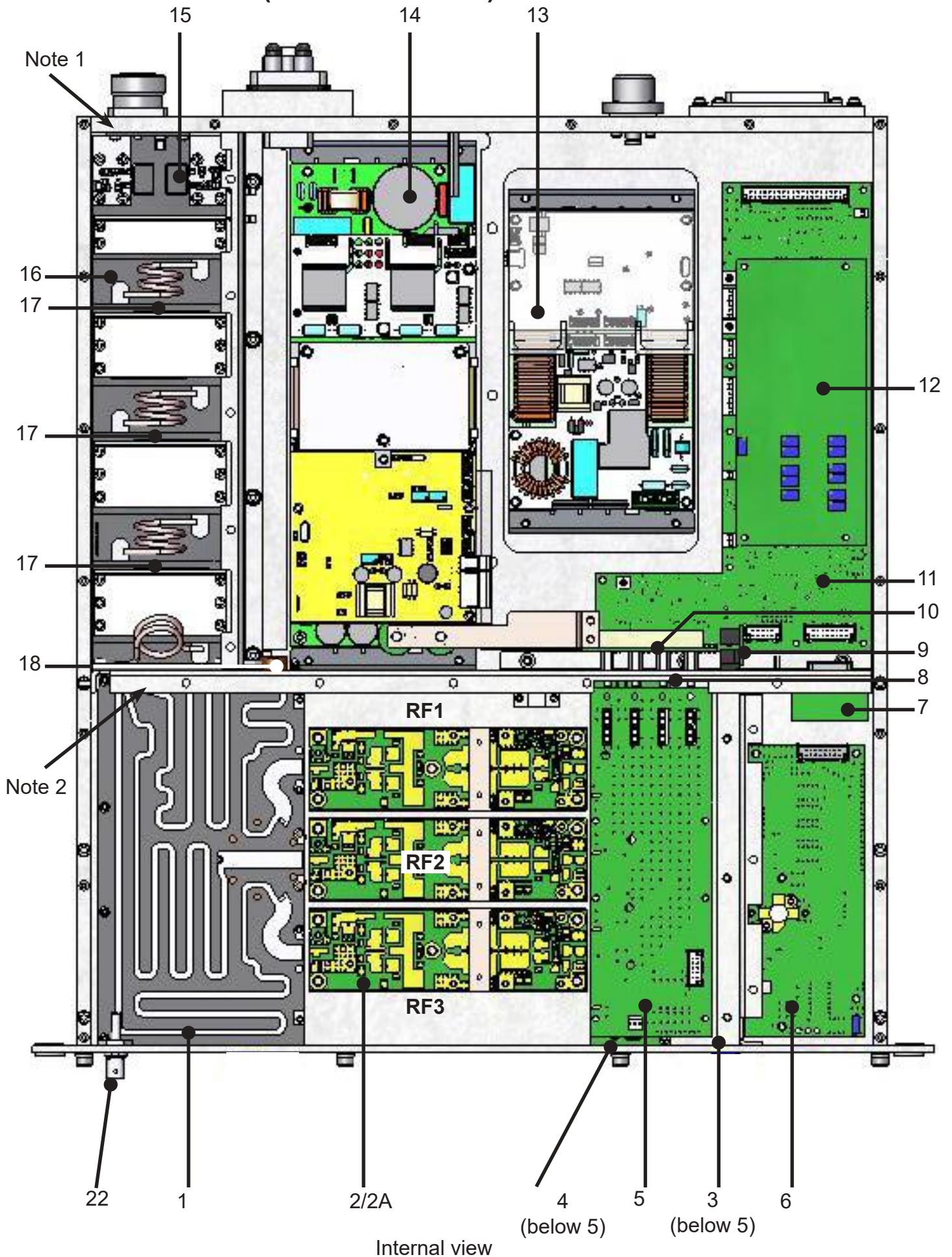

Internal view

N°	Description	Code	Technical annex page
1	3-way combiner	CSCMBMOD2KPJ	9
2	Pallet mosfet	KKFIN237L	10
2a	Planar pallet mosfet	KKFINPLAN-A	18
3	Temperature probe	SLSNDTMPJ5K	27
4	Splitter	CSSPLTEX1KL1	27
5	Fuses board	SLFU0359R01V01	28
6	Driver board	KKDRV243A	29
7	Db-15 connector filtered	SLDB15FMOD2K	/
8	Pass through board	SLFI0368R01V01	35
9	Db-9 connector filtered	SLDB9MFILF1	/
10	Shunt board	SLMT0367R01V01	36
11	Bias board	SLBI0358R02V01	37
12	CPU board (RF module)	CPUPLUGPJ10K-MOD	43
13	PFC	KPFCPSL4280HS.LC	49
14	Power supply	KPSL4280HS.LC	61
15	Directional coupler	SLDCLPPFJ10KCV	75
16	Low pass filter 1	CSLPF1MOD2KW	76
17	Capacitor 1	CSB1LPFPJ1KM	76
18	Temperature sensor 90° NA	SETBMET90NA	/
19	Card outlet connector	SLOUTRFPJ5K1	76
20	First capacitance low pass filter	CSLP0372R1	77
21	Low pass filter 2	CSLPF2MOD2KW	77
22	RF sample monitor	/	/

Note 1

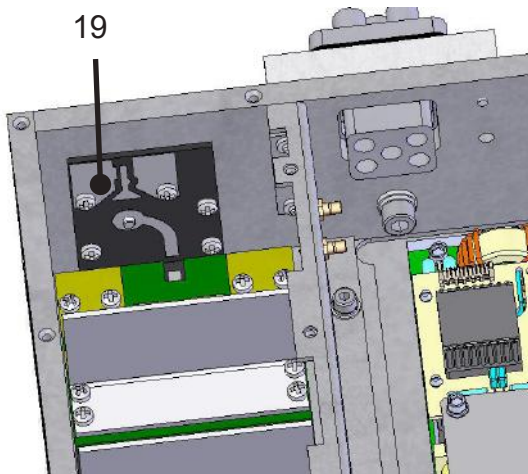

Note 2

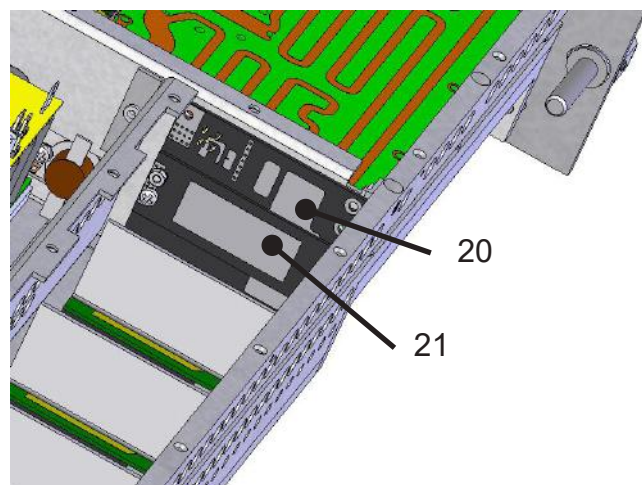

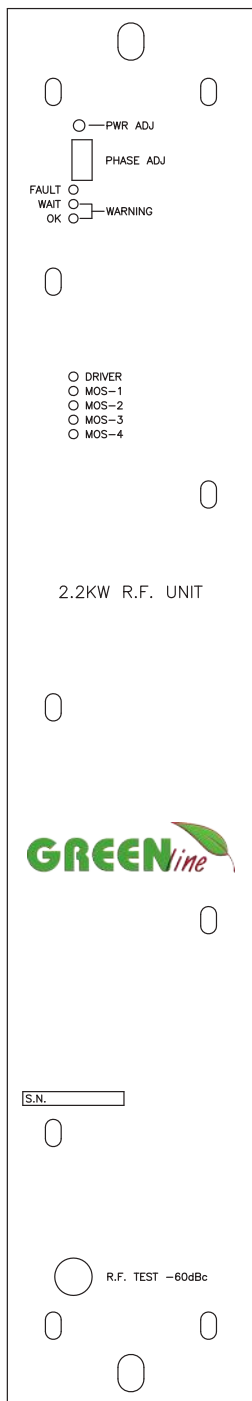

Front view

Function	Description
PWR ADJ	Trimmer adjustment of the output power of a single module, this control operates by varying the VPA pallet mosfet
PHASE ADJ	ip-switch for the regulation of the phase of the RF signal generated. The phase of each RF module could be modified independently to steps of 1.6° from- 12.8° to +11.2°. In some cases could result useful use the regulations of phase for minimize the unbalanced power dissipated. To this purpose, is preferable use the SERVICE menu, in which this value comes adjourned in real time.
FAULT	The module is switched off due to excessive operating parameter. You can see what he did turn off the module in the “Alarms” menu.
WAIT	Indicates a pre-alarm condition.
OK	Indicates that the module is on
DRIVER	Led on indicates the presence of voltage on driver
MOS-1	Led on indicates the presence of voltage on mosfet 1
MOS-2	Led on indicates the presence of voltage on mosfet 2
MOS-3	Led on indicates the presence of voltage on mosfet 3
MOS-4	Reserve
S.N.	Serial No. of the module
R.F. TEST -60dBc	RF sampling to the module output

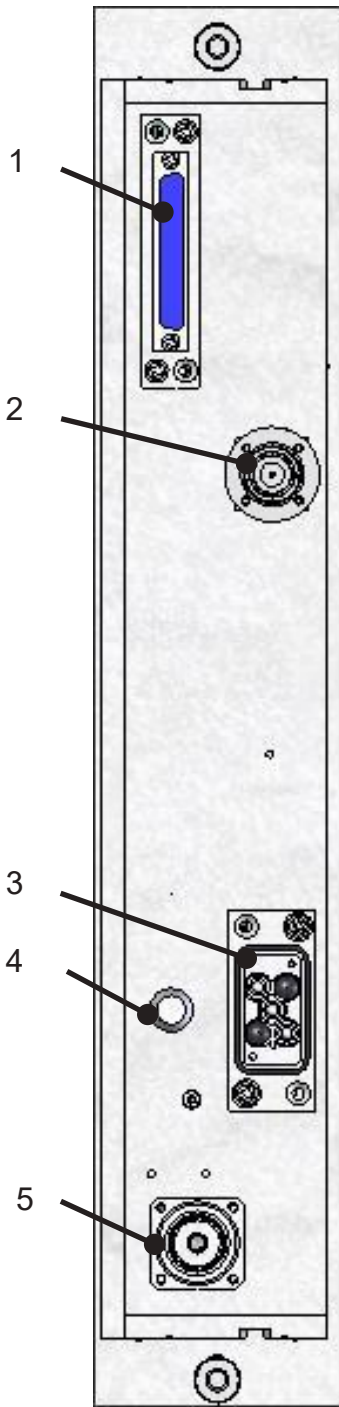

Rear view

1	DB-37 connector
2	RF input connector ("N" type)
3	Power supply connector Pin 1= Neutral Pin 2= NC Pin 3= NC Pin 4= Phase Pin 5= GND
4	Ground connector
5	RF output connector (7/16" EIA)

6.2.1 Settings CPU board (RF module)

In the PJ6KPS-CA are present microcontrol boards, one for each 2.2 kW module, one for the control of the power supply and one for the control of the combiner. In each board the trimmers have diverged meaning. In figure, “RFM” refers to the RF module, “PS” to the power supply and “CMB” to the combiner. TR12 is set so that VREF is 3.3 V.

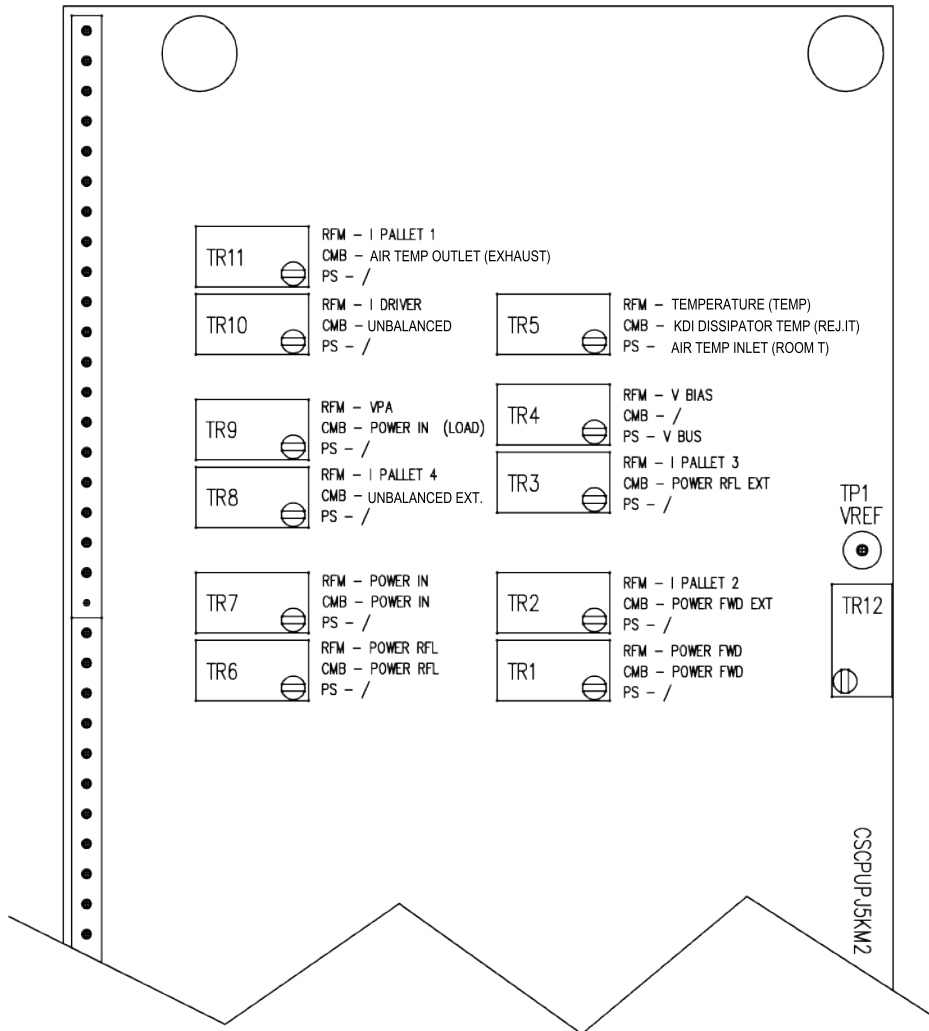

	RF Module	CoMBiner	Power Supply
TR1	Power FWD	Power FWD	/
TR2	I Pallet 2	Power FWD EXT	/
TR3	I Pallet 3	Power RFL EXT	/
TR4	V Bias	/	V Bus
TR5	Temperature (TEMP)	KDI Dissipator Temp (REJ.IT)	Air Temp Inlet (ROOM T)
TR6	Power RFL	Power RFL	/
TR7	Power IN	Power IN	/
TR8	I Pallet 4	Unbalanced EXT	/
TR9	VPA	Power IN (LOAD)	/
TR10	I Driver	Unbalanced	/
TR11	I Pallet 1	Air Temp Outlet (EXHAUST)	/

6.3 Electromechanical section

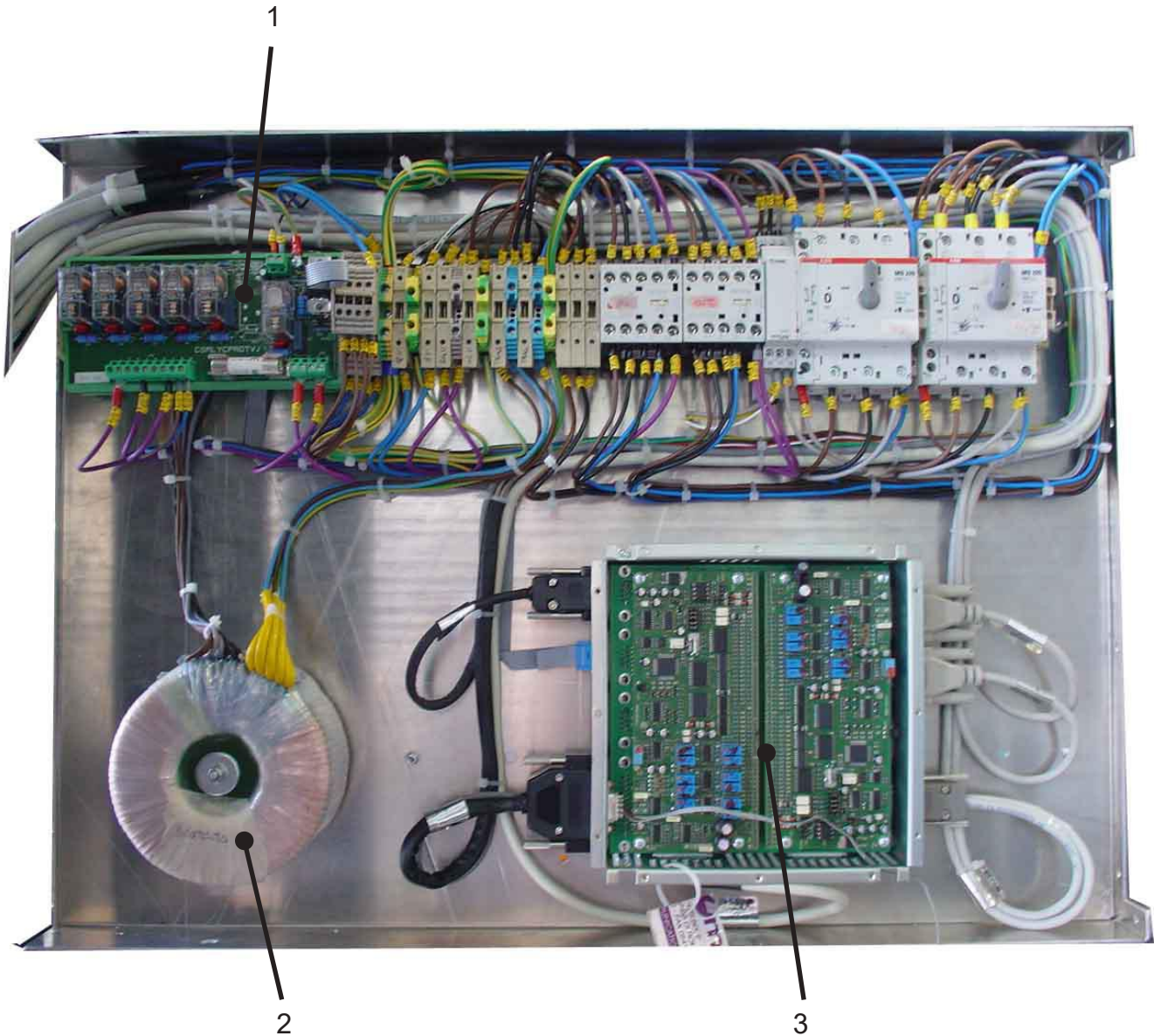

N°	Description	Code	Technical annex page
1	Relay interface board	CSRLYINTPJ10K	78
2	Service transformer	TRFSERV10KCV	/
3	P.S. combiner	PF1ADPSPJ5KM ↳ { <ul style="list-style-type: none"> SLADPSPJ5KM3 (PS combiner adapter) 80 CPUPLUGPJ10K-CMB (cpu combiner) 43 CPUPLUGPJ10K-PS (cpu power supply) 43 	

6.3.1 P.S. combiner (PF1ADPSPJ5KM)

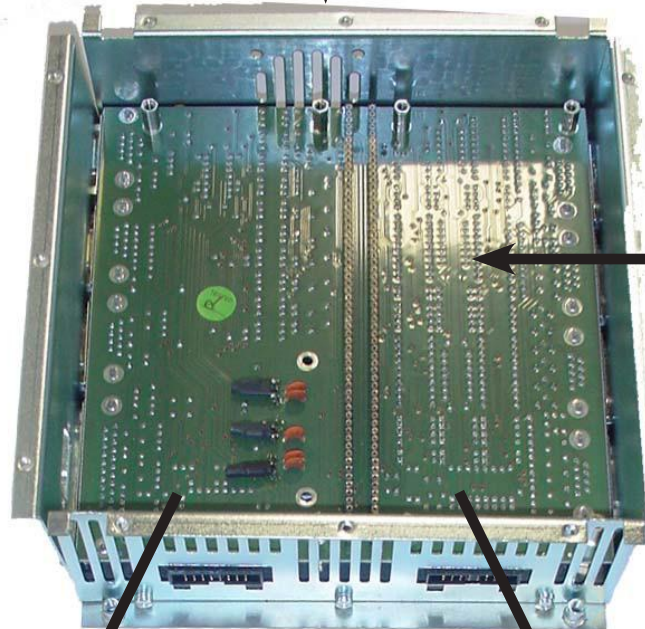

SLADPSPJ5KM3
(PS combiner adapter)

CPUPLUGPJ10K-PS
(cpu power supply)



CPUPLUGPJ10K-CMB
(cpu combiner)



6.3.2 P.S. combiner trimmer

In the PJ6KPS-CA are present microcontrol boards, one for each 2.2 kW module, one for the control of the power supply and one for the control of the combiner. In each board the trimmers have diverged meaning. In figure, “RFM” refers to the RF module, “PS” to the power supply and “CMB” to the combiner. TR12 is set so that VREF is 3.3 V.



PS (power supply)

CMB (combiner)

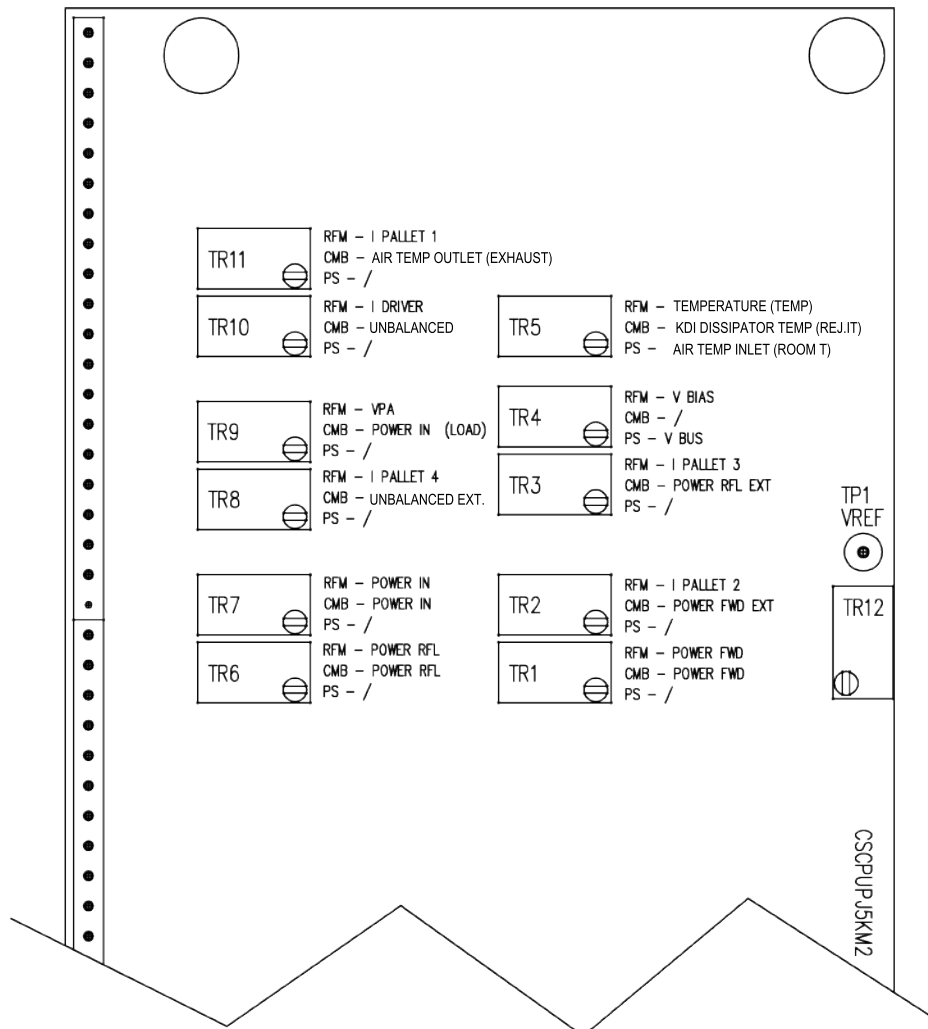

	RF Module	CoMBiner	Power Supply
TR1	Power FWD	Power FWD	/
TR2	I Pallet 2	Power FWD EXT	/
TR3	I Pallet 3	Power RFL EXT	/
TR4	V Bias	/	V Bus
TR5	Temperature (TEMP)	KDI Dissipator Temp (REJ.IT)	Air Temp Inlet (ROOM T)
TR6	Power RFL	Power RFL	/
TR7	Power IN	Power IN	/
TR8	I Pallet 4	Unbalanced EXT	/
TR9	VPA	Power IN (LOAD)	/
TR10	I Driver	Unbalanced	/
TR11	I Pallet 1	Air Temp Outlet (EXHAUST)	/

6.4 Parallel interface (opz.)(INTREMPJ5K)

A parallel-type interface is mounted on the top of the TXF6K-0161, in which the different signals are available through terminal blocks (Figure 6.4.1). This interface is connected to the CU from which it receives the different signals and to which the eventual commands are forwarded.

The card contains digital inputs, digital outputs and analog outputs. Among the digital inputs, a “copy” of all the possible orders that can be given locally to the unit by using the buttons of the control unit are displayed.

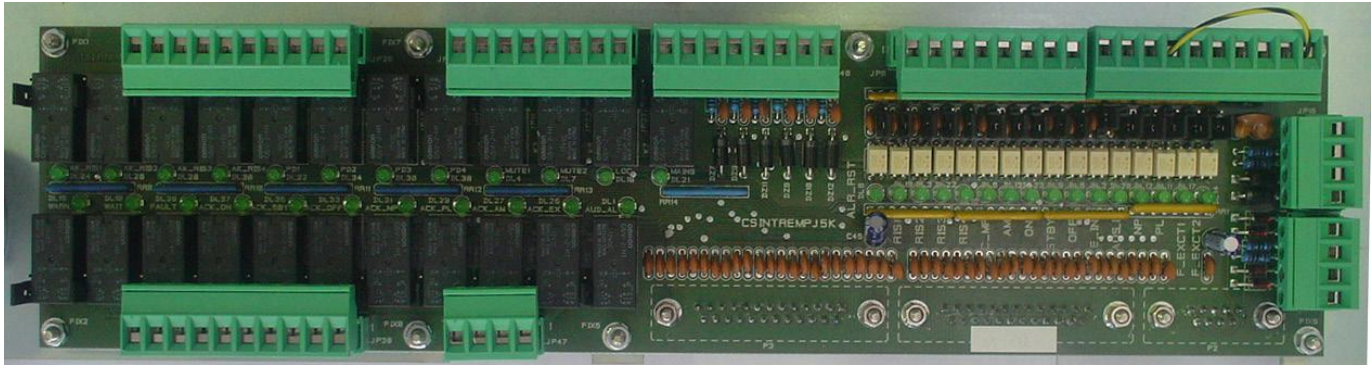

Figure 6.4.1

The digital outputs supply information concerning the status of the PJ6KPS-CA. The analogue outputs enable the remote control of the most important parameters, for example the forward and reflected power.

This interface was designed for a maximum configurability and adaptability to the tel metry systems to which it may be connected. For example, each digital input can be configured through a jumper in order to be “active” when grounded or when connected to a supply source between +12V and +24V.

The scheme of one generic digital input is shown in Figure 6.4.2 b). Please pay attention to the anti-parallel type optocouplers, so that if the jumper is closed between the pins 1 and 2, by grounding the DIGITAL INPUT, the input is active. On the contrary by closing 2 and 3, the input is active when the DIGITAL INPUT is connected to a positive voltage. Each digital output can be configured individually as “Normally open “ or “Normally closed “ (NO or NC). In Figure 6.4.2 a) the scheme of a generic digital output is shown. Please note that when the jumper is closed between 1 and 2, the output is normally short-circuited with the common pin, while in the other case the circuit is normally open.

It is important to remember that the different commands can be given to the unit through the parallel interface only if the Local/Remote selector situated on the front panel is on the “Remote” position.

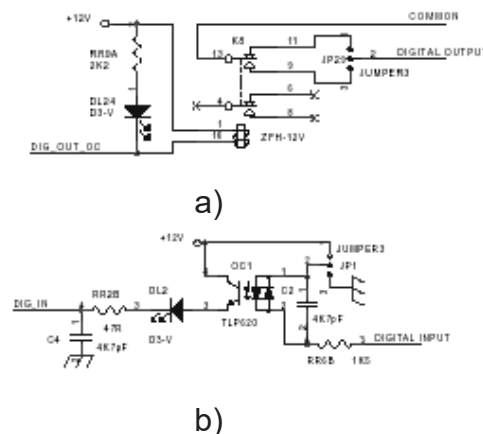

Figure 6.4.2

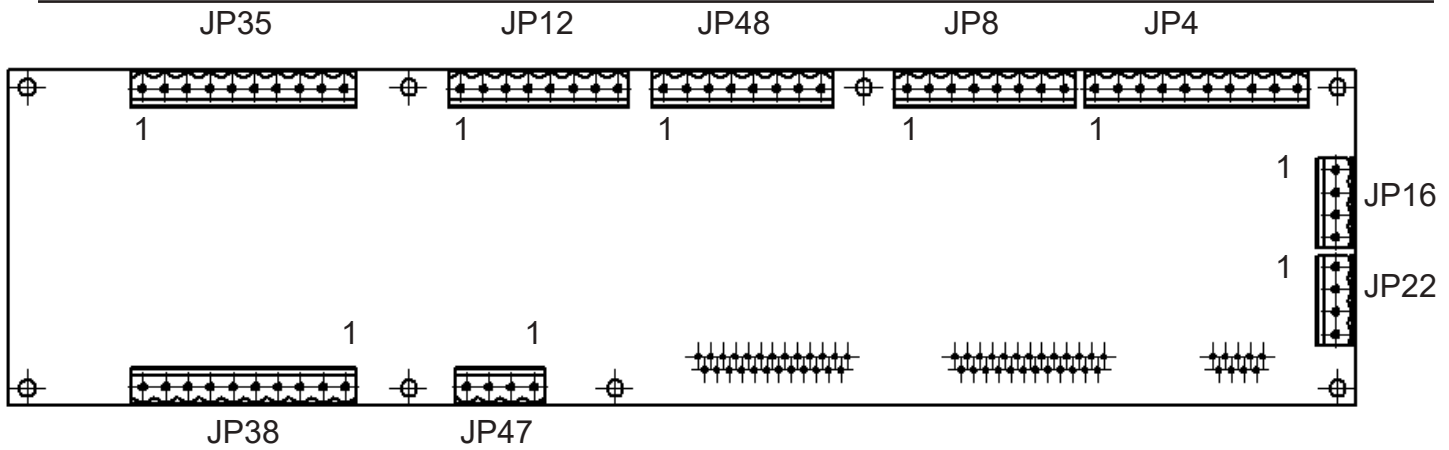

Figure 6.4.3

The following table describes the function of each jumper of the parallel interface. The first column indicates the identifying number of the jumper as shown on Figure 6.4.3, the second indicates the name of the signal and the third column describes its function.

Clamp	Type	Name	Description
JP4/1	In	ON	Corresponds to the ON button of the control unit
JP4/2	In	STDBY	Corresponds to the STDBY button of the control unit
JP4/3	In	OFF	Corresponds to the OFF button of the control unit
JP4/4	In	EXT INH	External inhibition jumper. It is a “N.C.” type jumper, which means that it must be active for the PJ6KPS-CA to work. Upon delivery, this terminal is closed to ground by a jumper.
JP4/5	In	AUX INH	Auxiliary external inhibition jumper. It is a “N.O.” type jumper, which means that it must be not active for the PJ6KPS-CA to work. It is “auxiliary” because even if nothing is connected to it the PJ6KPS-CA works normally.
JP4/6	In	NOM PWR	Corresponds to the NOMINAL POWER button of the control unit
JP4/7	In	LOW PWR	Corresponds to the REDUCED POWER button of the control unit
JP4/8	In	AUDIO ALARM EXC. 1	Audio alarm of exciter 1. This input, when active, indicates an alarm on exciter 1. If the PJ6KPS-CA is in automatic changeover modality, if the exciter 1 is on air and if this signal remains active for a time lag equivalent to the time setted in the Settings menu at line Exc. Wait time, the changeover procedure between the exciters will be started.
JP4/9	In	AUDIO ALARM EXC. 2	Same as AUDIO ALARM EXC. 1 for exciter 2.
JP4/10	/	GND	Grounding contact.
JP8/1	In	ALARM RESET	Corresponds to the ALARM RESET button on the control unit
JP8/2	In	RESRV. 1	Reserve 1 input. When this input is active, the failure is registered by the software in the Alarms menu. For example it can be connected to a switch that indicates that the door of the station is open or to a sensor of a power reserve of an electric generator. In this way, by consulting the menus of the unit, it is possible to trace the moment at which (time and date) the failure occurred.
JP8/3	In	RESRV. 2	Same as JP8/2
JP8/4	In	RESRV. 3	Same as JP8/2
JP8/5	In	RESRV. 4	Same as JP8/2

JP8/6	In	EXCITER CHANGEOVER CMD	This command launches the changeover procedure between the exciters. It has the same function as when you press the OK button when selecting line On air exciter in the menu Exciters. In order to launch the changeover between the exciters through this command, the manual changeover modality should be formerly selected through the correspondent button on the control unit or through the JP8/7 jumper, having however the unit in "Remote" modality.
JP8/7	In	EXCITER CHANGEOVER	Corresponds to the EXCITER CHANGEOVER button of the control unit
JP8/8	/	GND	Ground
JP16/1	Out	+12V dc	Power source. A maximum of 100 mA can be absorbed between this jumper and JP16/2. This power source can be used if the user wants to enter the commands following a positive logic (high voltage - active command)
JP16/2	Out	+12V dc	Same as JP16/1
JP16/3	/	GND	Ground
JP16/4	/	GND	Ground
JP22/1	I/O	TX/RX +	Bus RS 485. Please note that this serial port is operational only when the unit is in "Remote" modality.
JP22/2	I/O	TX/RX -	Bus RS 485
JP22/3	/	LINE TRM	Line termination for bus RS 485
JP22/4	/	LINE TRM	Line termination for bus RS 485
JP48/1	/	GND	Ground
JP48/2	/	GND	Ground
JP48/3	Out	FWD PWR	Forward power. Analog output, 3.9V for 5000W
JP48/4	Out	RFL PWR	Reflect power. Analog output, 3.9V for 1200W
JP48/5	Out	OUT AIR TEMP	Temperature of the air at the output of the chimney. Analog output, 0V for -50°C, 3.9V for 100°C
JP48/6	Out	V FAN	Supply voltage of the fans.
JP48/7	Out	EFF.	General efficiency. Analog output, 3.9V for 100%, 0V for 0%.
JP48/8	Out	OUT DAC 6	Reserved for future applications.
JP12/1	Out	CMN MUTE 1	Common contact MUTE 1 (see JP12/2).
JP12/2	Out	MUTE 1	MUTE exciter 1. Digital output, active when exciter 1 is inhibited by the control unit. Like all the digital outputs on the parallel interface, it can be configured through jumper as normally open or normally closed. This output has a common contact dedicated to this function (JP12/1).
JP12/3	Out	CMN MUTE 2	Common contact MUTE 2 (see JP12/4).
JP12/4	Out	MUTE 2	MUTE exciter 2. Digital output, active when exciter 2 is inhibited by the control unit. This output has a common contact dedicated to this function (JP12/3).
JP12/5	Out	CMN LOCAL	Common contact LOCAL (see JP12/6).
JP12/6	Out	LOCAL	LOCAL/REMOTE status. Digital output, active when the PJ6KPS-CA is set in local modality. This output has a common contact dedicated to this function (JP12/5).
JP12/7	Out	CMN MAINS	Common contact MAINS (see JP12/8).
JP12/8	Out	MAINS	MAINS alarm, active when are present problems on the alimentation

JP47/1	Out	AUDIO ALARM	“AUDIO” alarm (see JP4/8 and JP4/9). This output is active when the on air exciter is in audio alarm status. This output has a common contact dedicated to this function (JP47/2).
JP47/2	Out	CMN AUDIO ALARM	Common contact AUDIO ALARM (see JP47/1).
JP47/3	Out	CMN RL3	Common contact shared from the outputs JP38/1-10.
JP47/4	Out	CMN RL3	Parallel contact with JP47/3.
JP35/1	Out	RESRV. 1	Reserve 1. Digitale output, active when the INPUT RESERVE 1 input (JP8/2) is active. The common contact of this output is RL4 (JP35/5)
JP35/2	Out	RESRV. 2	Same as JP35/1, corresponds to INPUT RESERVE 2. The common contact of this output is RL4 (JP35 / 5)
JP35/3	Out	RESRV. 3	Same as JP35/1, corresponds to INPUT RESERVE 3. The common contact of this output is RL4 (JP35 / 5)
JP35/4	Out	RESRV. 4	Same as JP35/1, corresponds to INPUT RESERVE 4. The common contact of this output RL4 (JP35/5)
JP35/5	Out	CMN RL4	Common contact shared between different digital outputs (JP35/1-4)
JP35/6	Out	SET1.	Digital output, active when the parameter SET1 is active (see menu Settings). The common contact of this output RL5 (JP35/10).
JP35/7	Out	SET2.	Same as JP36/6, corresponds to SET2. The common contact of this output is RL5 (JP35/10).
JP35/8	Out	SET3.	Same as JP36/6, corresponds to SET3. The common contact of this output is RL5 (JP35/10).
JP35/9	Out	SET4.	Similar to JP36/6, related to SET4. The common contact of this output is the RL5 (JP35/10).
JP35/10	Out	CMN RL5	Common contact shared between the different digital output (JP35/6-9)
JP38/1	Out	EXC. ON AIR	Digital output, active when the exciter 1 is on air, and not active when the exciter 2 is on air. common contact of this output is the RL3 (JP47/3).
JP38/2	Out	AUTO/MAN	Digital output, active when the PJ6KPS-CA is in changeover mode as regards the exciters. The common contact of this output is RL3 (JP47/3).
JP38/3	Out	LOWER POWER	Digital output, active when the PJ6KPS-CA is set for the lower power level. Common contact of this output is the RL3(JP47/3).
JP38/4	Out	NOMINAL POWER	Digital output, active when the PJ6KPS-CA is set for the nominal power level. common contact of this output is the RL3 (JP47/3).
JP38/5	Out	OFF	Digital output, active when the PJ6KPS-CA is set for the lower power level. The common contact of this output is the RL3 (JP47/3).
JP38/6	Out	STDBY	Digital output, active when the PJ6KPS-CA is set for the lower power level. The common contact of this output is the RL3 (JP47/3).
JP38/7	Out	ON	Digital output, active when the PJ6KPS-CA is set on ON mode. The common contact of this output is the RL3 (JP47/3).
JP38/8	Out	FAULT	Digital output, active when the PJ6KPS-CA is set on FAULT mode. The common contact of this output is the RL3 (JP47/3).
JP38/9	Out	WAIT	Digital output, active when the PJ6KPS-CA is set on WAIT mode. The common contact of this output is the RL3 (JP47/3).
JP38/10	Out	WARNING	Digital output, active when the PJ6KPS-CA is set on WARNING mode. The common contact of this output is the RL3 (JP47/3).

6.4.1 Interlock dummy load / transmitter

Connected to this terminal, the interlock of dummy load.

Closed = OK
Open = ALARM

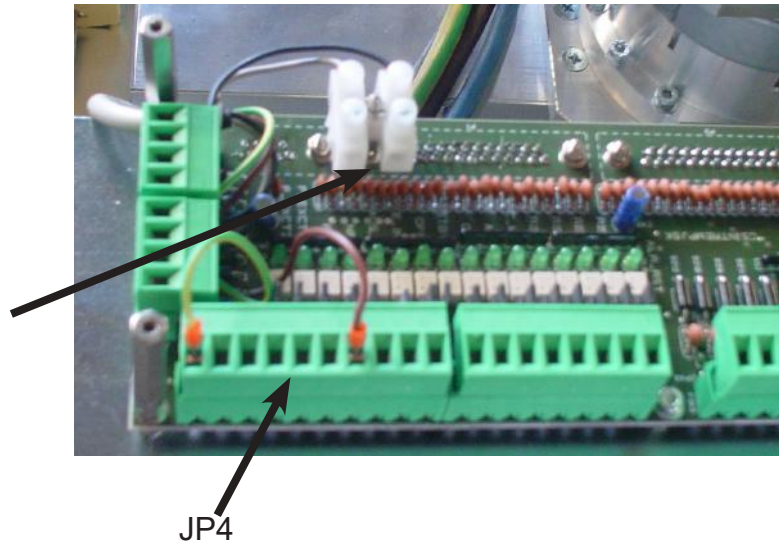

If the transmitter is on ANTENNA through the COAX RELAY, the interlock of dummy load is skipped. If the transmitter is on DUMMY LOAD through the COAX RELAY, the interlock operates.

If you want to bypass the COAX RELAY, for example in the case of maintenance, you have to remove the connector JP4 and insert the connector with the bridge.

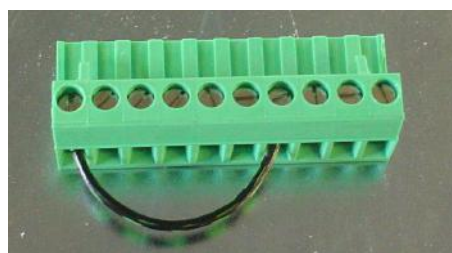
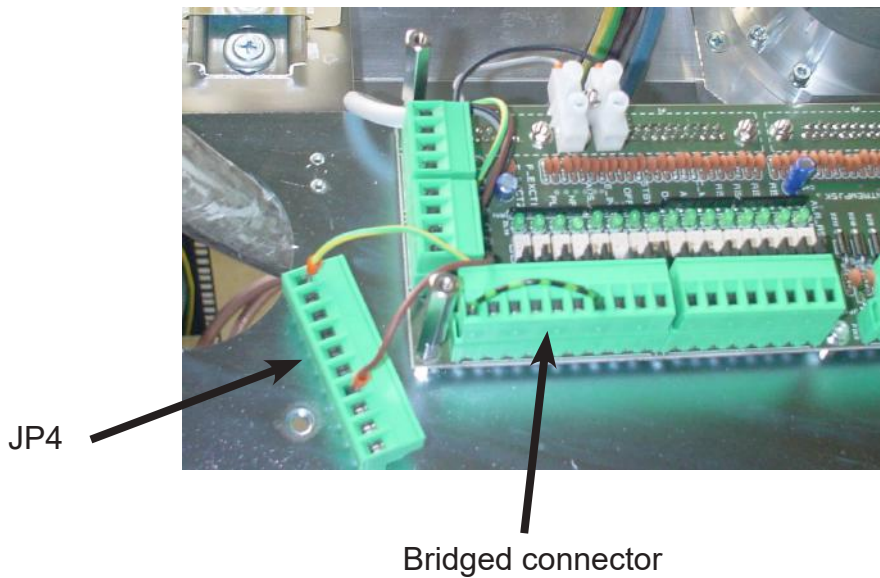

6.5 RF Module box

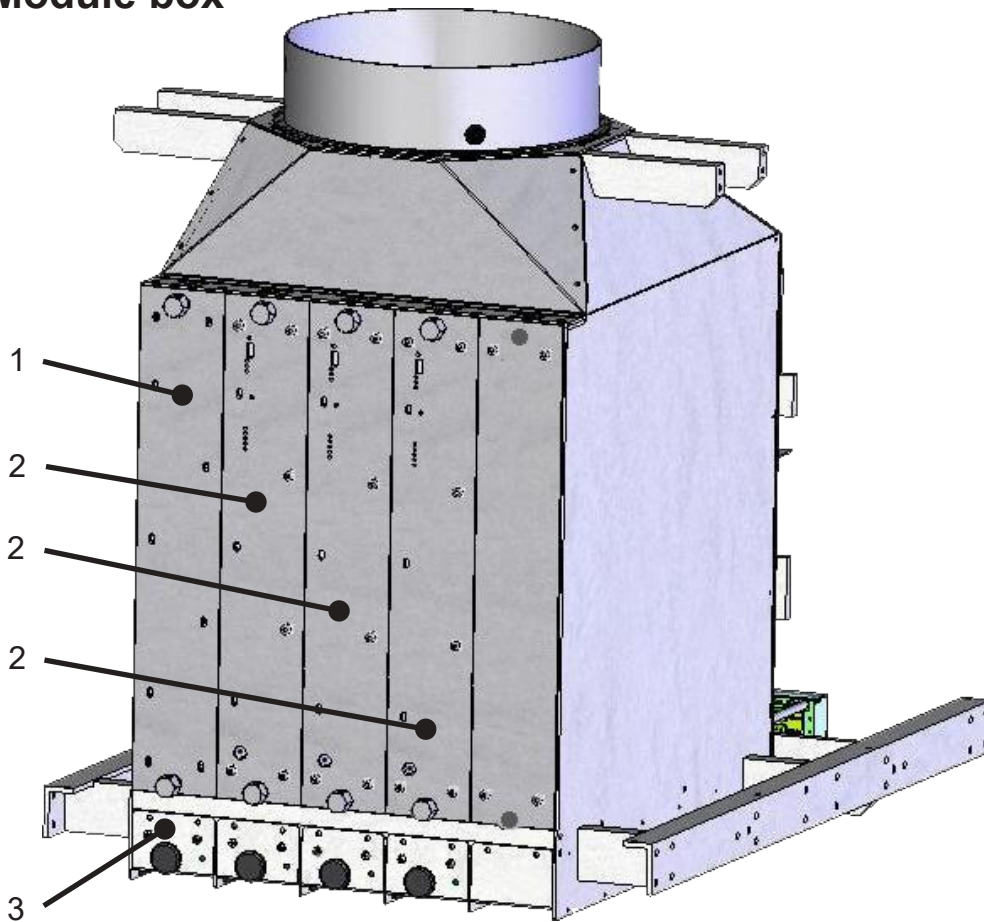

N°	Description	Chapter of this manual	Technical annex page
1	Rejected load	6.11	/
2	RF module (N° 1 from left)	6.2	/
3	Tray fans	6.5.1	/
4	RF module I/O interface	6.5.2	92
5	Presence module switch	/	/
6	Power supply board tray fans	6.5.3	/
7	Dummy load interface	/	109
8	Input unbalanced power to dummy load	/	/
9	Blower rejected load contactor	/	/

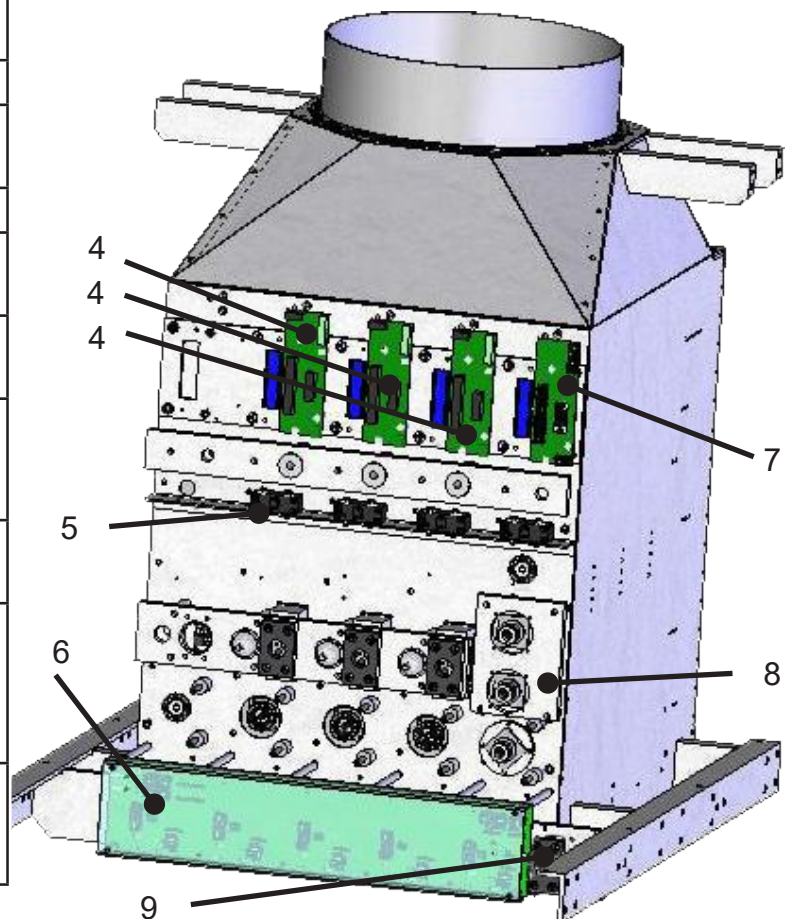

6.5.1 Tray fans (CASVTLMPJ10KCV)

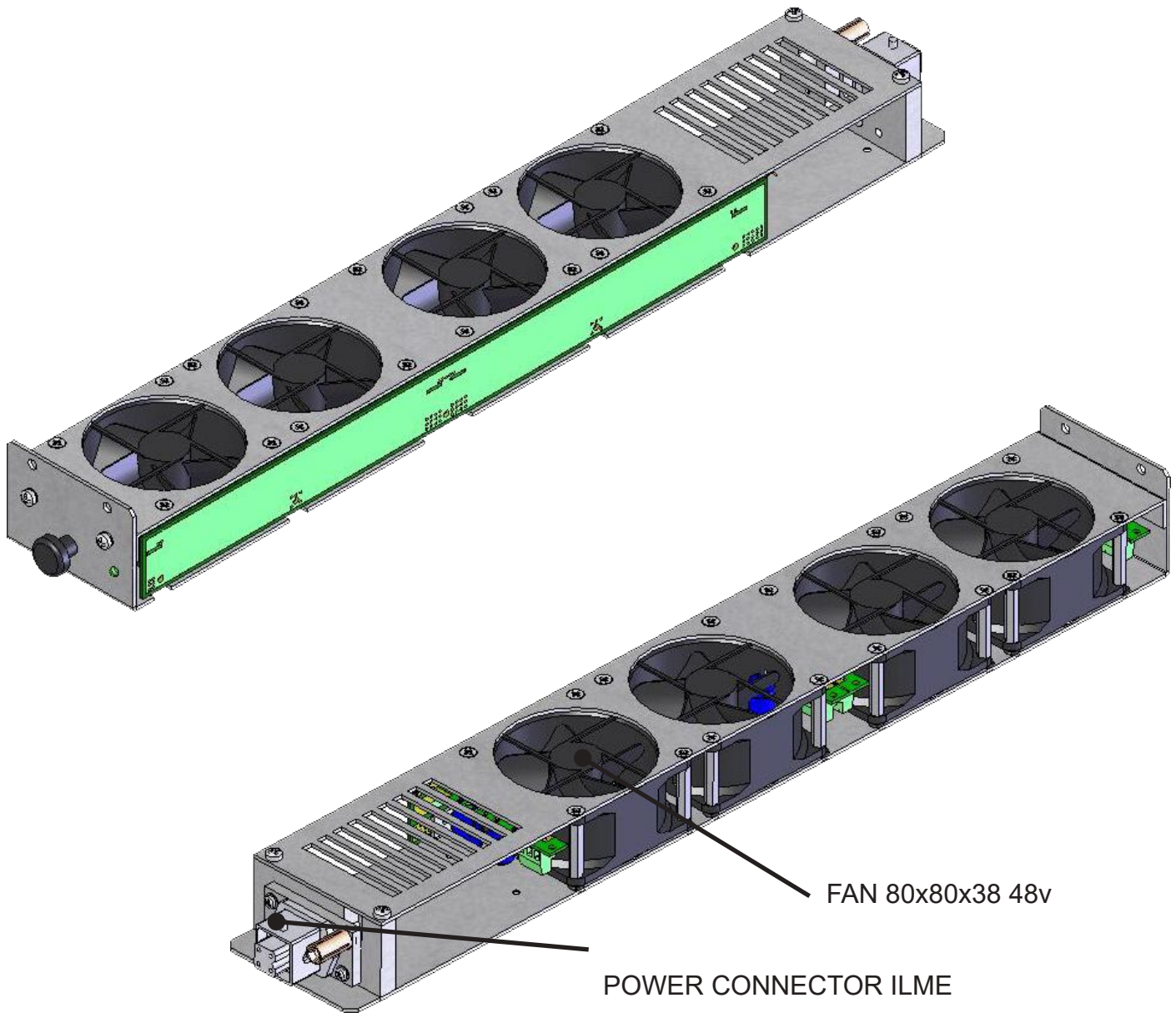

Pinout ilme male power supply

Pin	Cable color	Description
1	Red	+ (48V DC)
2	Gray	Speed control
3	Black	- (0 V)
GND	Black	- (0 V)

6.5.1.1 PCB fan voltage

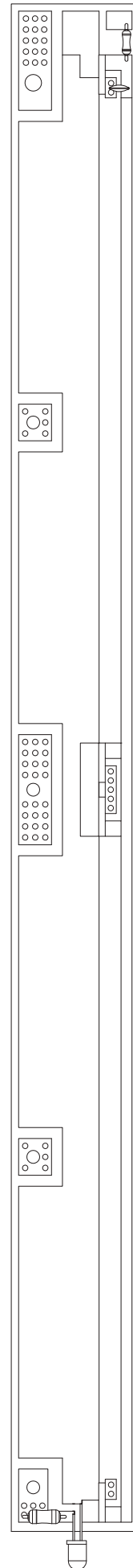
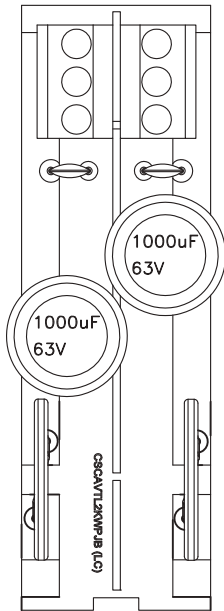

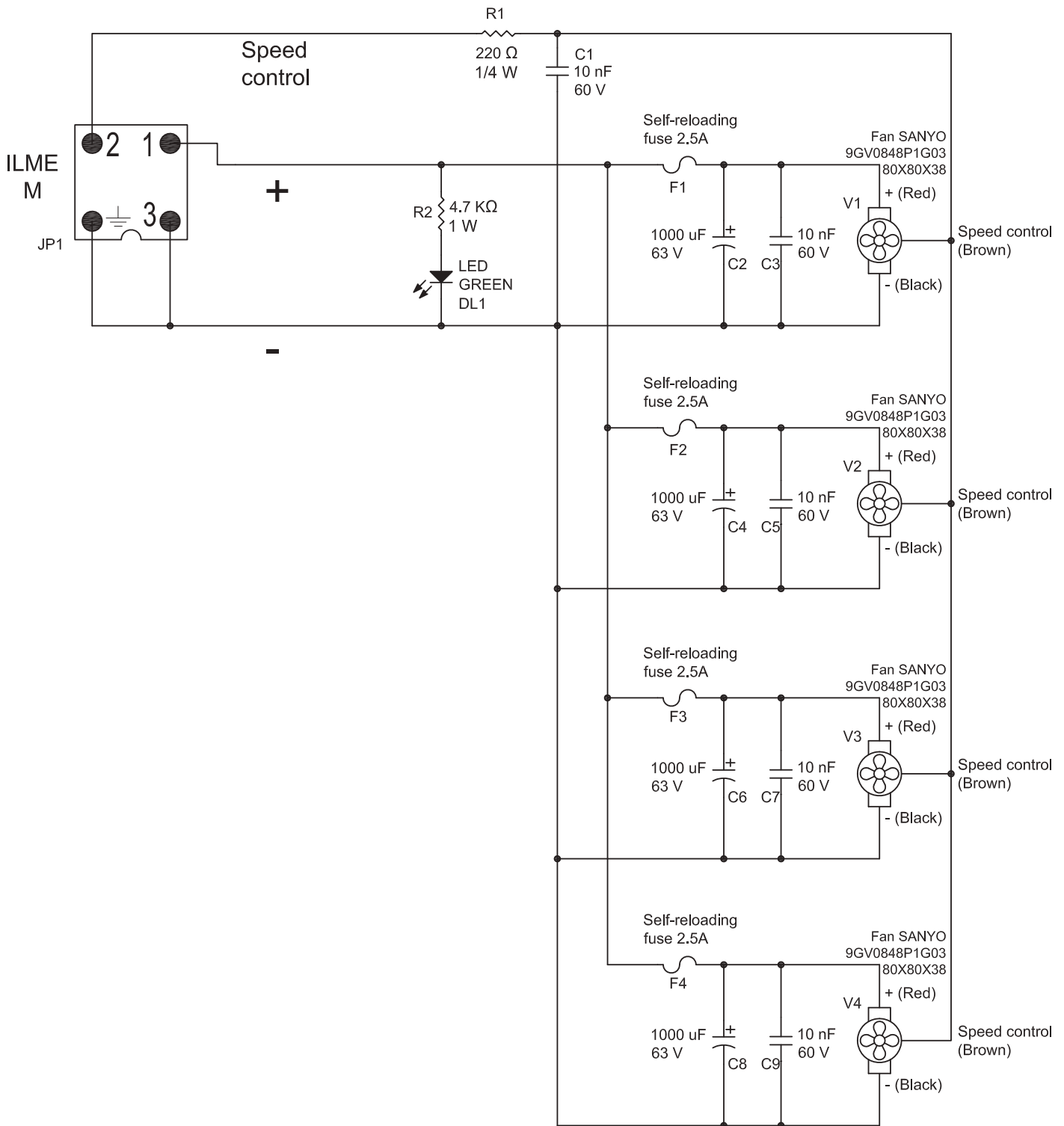

CSALVTL2KWPJA/CSALVTL2KWPJB - Bill of material

Item	Qty	Reference	Part	Description
1	1	JP1	Ilme connector 4 poles	Ilme connector 4 poles male + cover
2	1	R1	220 ohm	Resistor 1/4W
3	1	R2	4,7 kohm	Resistor 1W
4	1	DL1	Green led	Diode led 5mm
5	5	C1,C3,C5,C7,C9	100nF 60V (disc)	Disc capacitor
6	4	C2,C4,C6,C8	1000uF 63V (electr.)	Electrolytic capacitor
7	4	V1,V2,V3,V4	80x80x38 48v	Fan SANYO 9GV0848P1G03 80X80X38 48v
8	4	F1,F2,F3,F4	250V 2,5A	Self-reloading fuse
9	4	/	Screw terminal 3 poles	Screw terminal 3 poles solder

6.5.2 RF module address

The address assigned to the module is mailed by a dip-switch on the interface board (SW1). In figure are brought back the configurations assigned to the different settings. The RF module 1 (that more on top looking at the transmitter from the front) have address 8, the 2 has address 9 and so on until at 17. The other addresses are reserved for future uses.

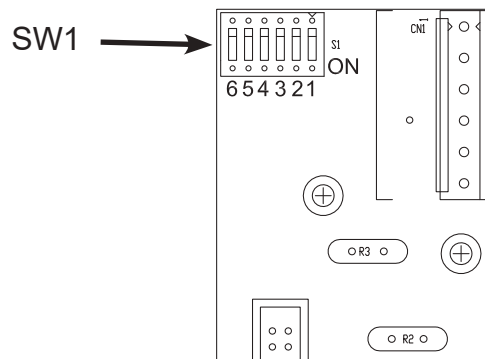
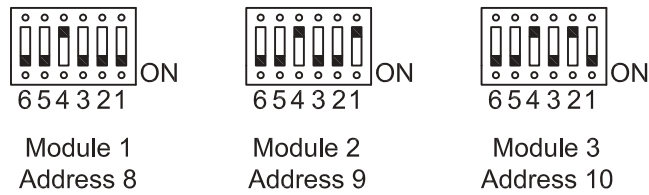

6.5.3 Power distribution board tray fans (CSALVTL2KWPJ)

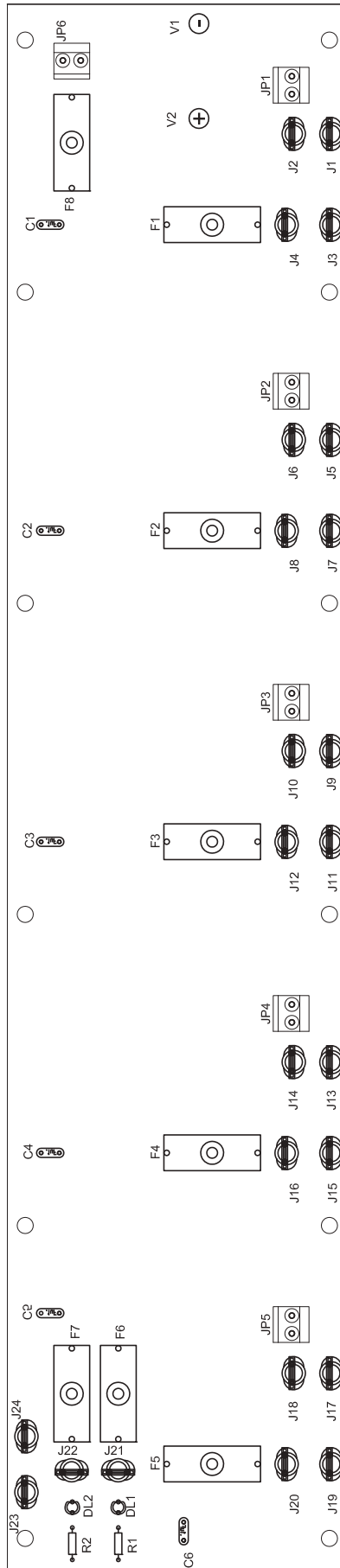

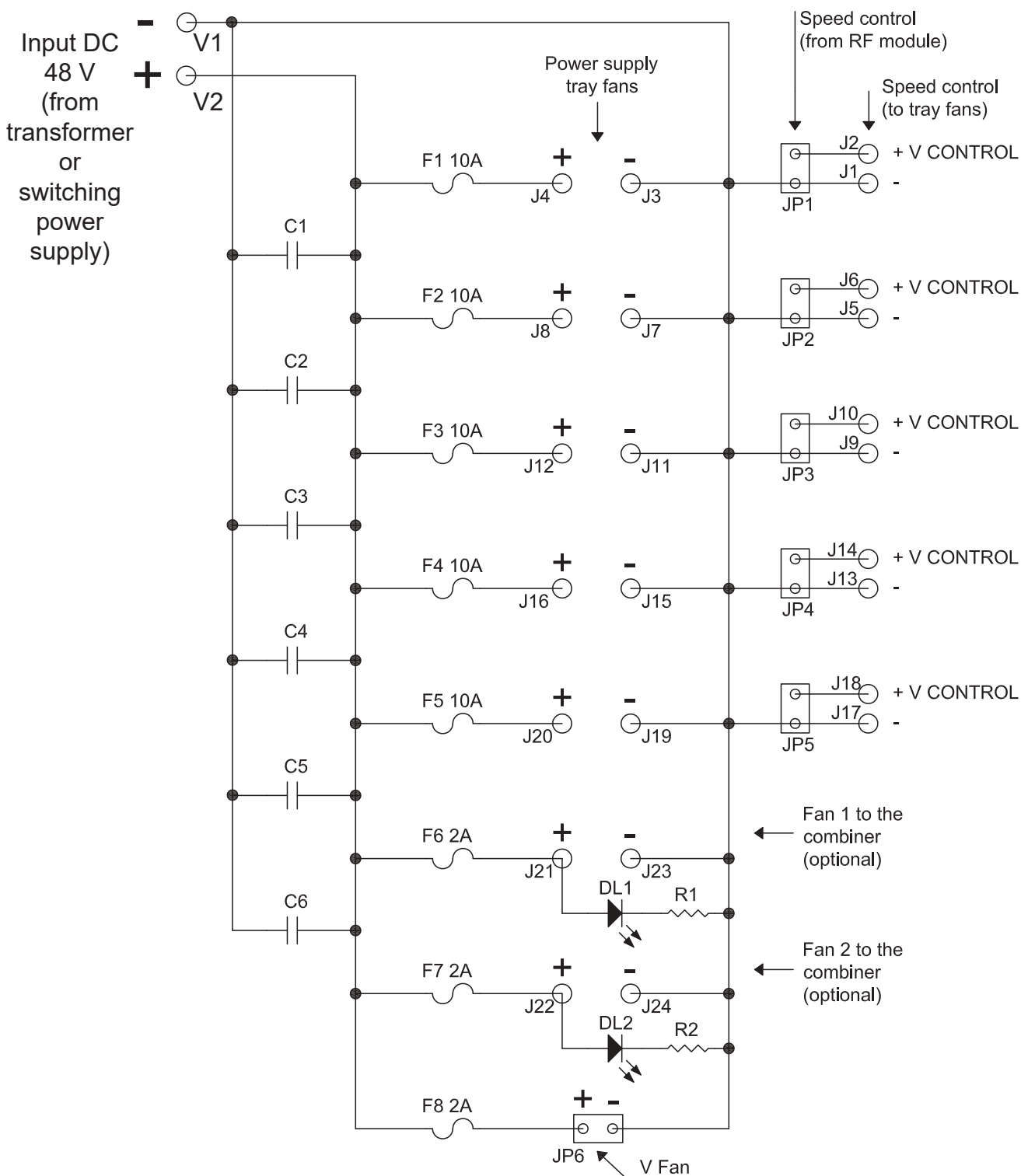

CSALVTL2KWPJ - Bill of material

Item	Qty	Reference	Part
1	6	JP1,JP2,JP3,JP4,JP5,JP6	
2	24	J1,.....,J24	
3	8	F1,F2,F3,F4,F5,F6,F7,F8	
4	2	/	/
5	2	R1,R2	4,7 kohm
6	6	C1,C2,C3,C4,C5,C6	100nF 63V
7	8	DL1,DL2	Green led

6.5.4 Power supply tray fans

With threephase transformer

Electromechanical section

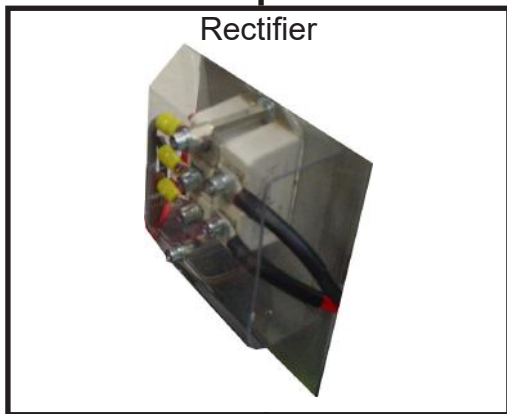

Power distribution board

With switching power supply

Electromechanical section



Power distribution board

6.6 Combiner e splitter

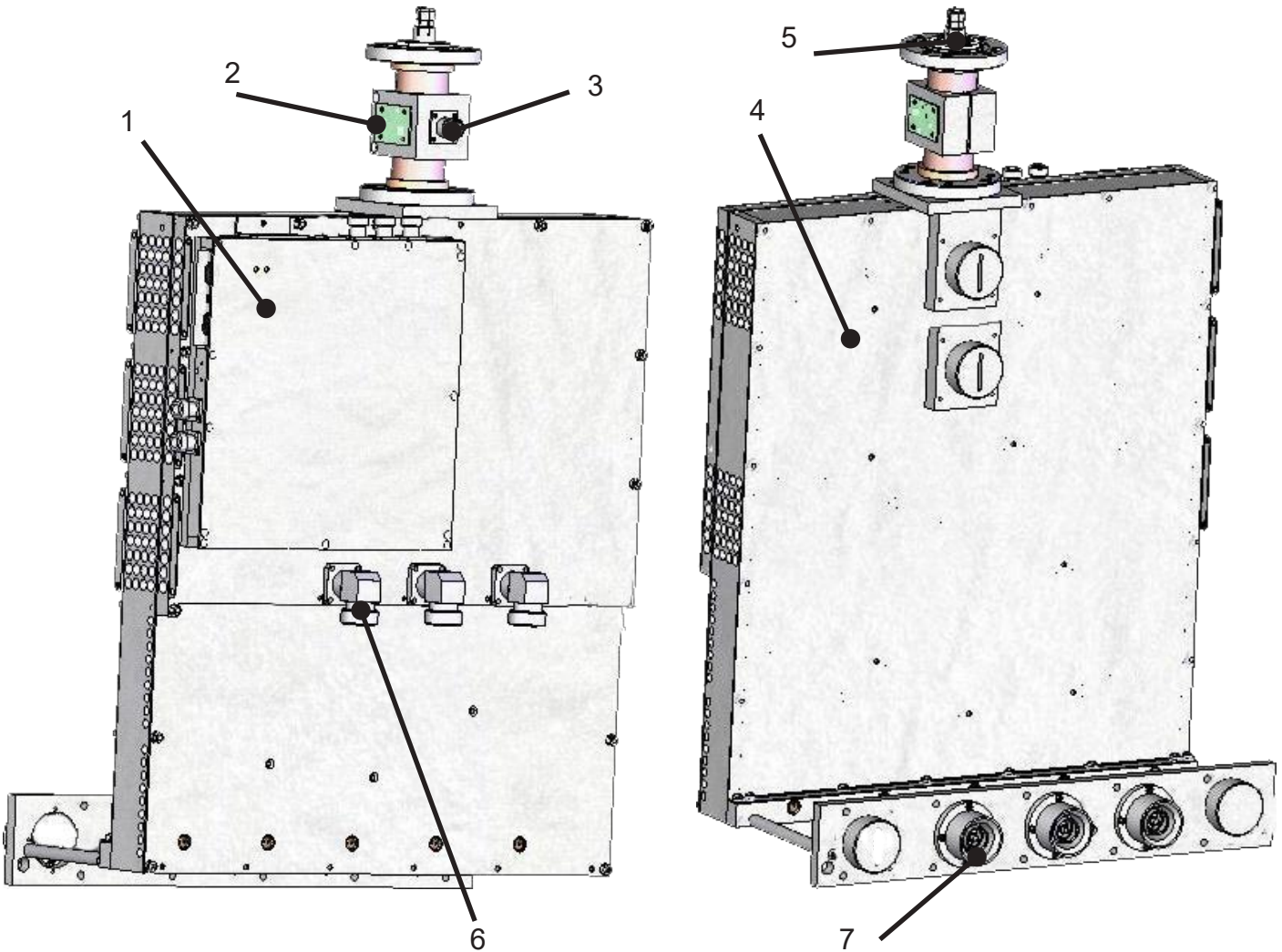

N°	Description	Code	Technical annex page
1	Splitter	PF1SPLNPJ5KM { SLSPLMEA5KW1 SLSPLINP5KW1	100 101
2	Directional coupler	SL042MT1001	97
3	RF probe	/	/
4	Combiner	PF1HC510KWPJ-318	99
5	RF output EIA 3+1/8"	/	/
6	Connection to dummy load	/	/
7	RF input from module	/	/

6.6.1 RF combiner schematic

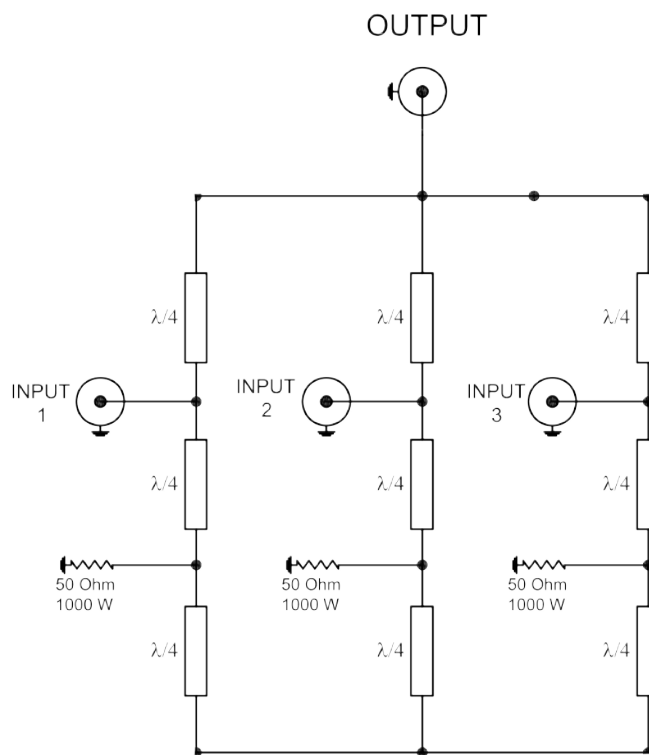

MODEL OF THE ELECTRIC SHEMATIC OF 3-WAY COMBINER

6.6.2 Splitter board trimmers

On the entry splitter board are present two trimmers for the regulation of the measure of the emitted power from the two exciters.

These measures are those visible in the EXCITERS menu.

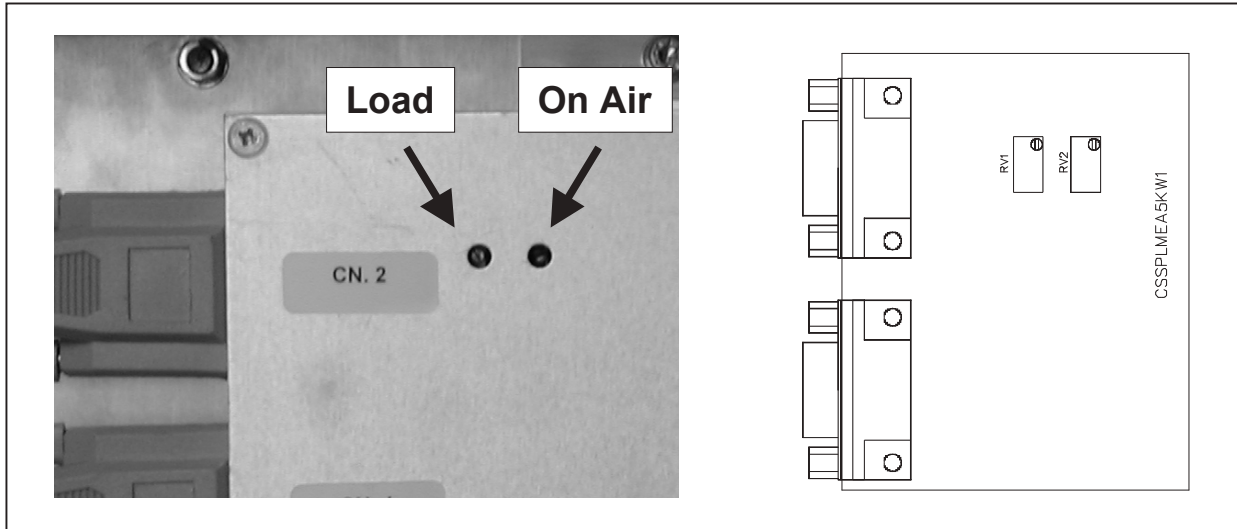

On the circuits of power measure of the exciters there are two compensators to maximize the directive and minimize the operation error measure of the frequency of operation.

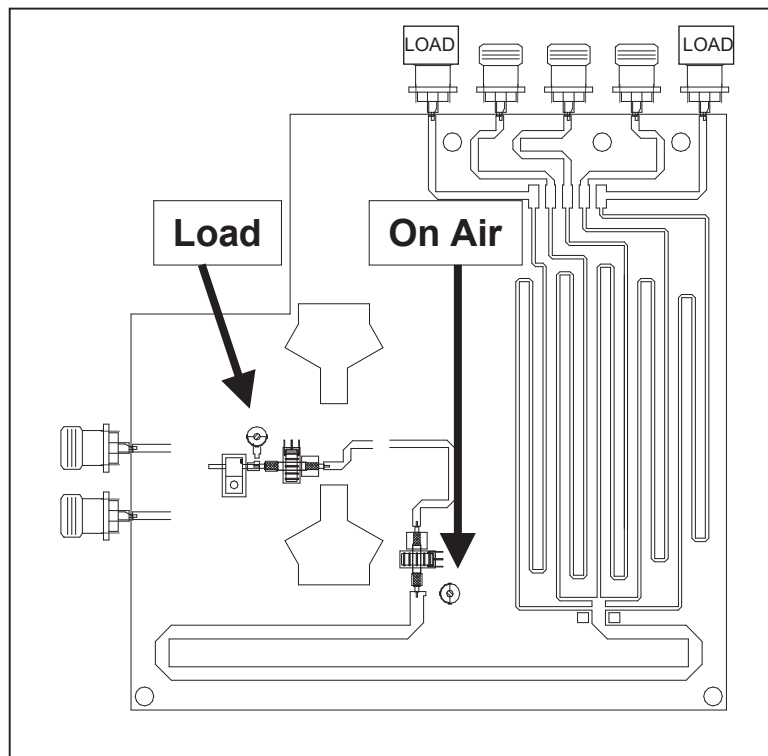

6.7 Installation emergency CCU Board

In the case the control unit presents a damage, it is possible assure the correct operation replacing, temporarily, the control panel with the card furnished together with the PJ6KPS-CA.

To effect the substitution, execute the following instructions:

- 1) Switch-OFF the amplifier. Remove the screw on the left side of the LCD panel, open the panel and individualize the necessary connectors to the operation of the emergency card.



- 2) Disconnect all the cables connected to the unit control.

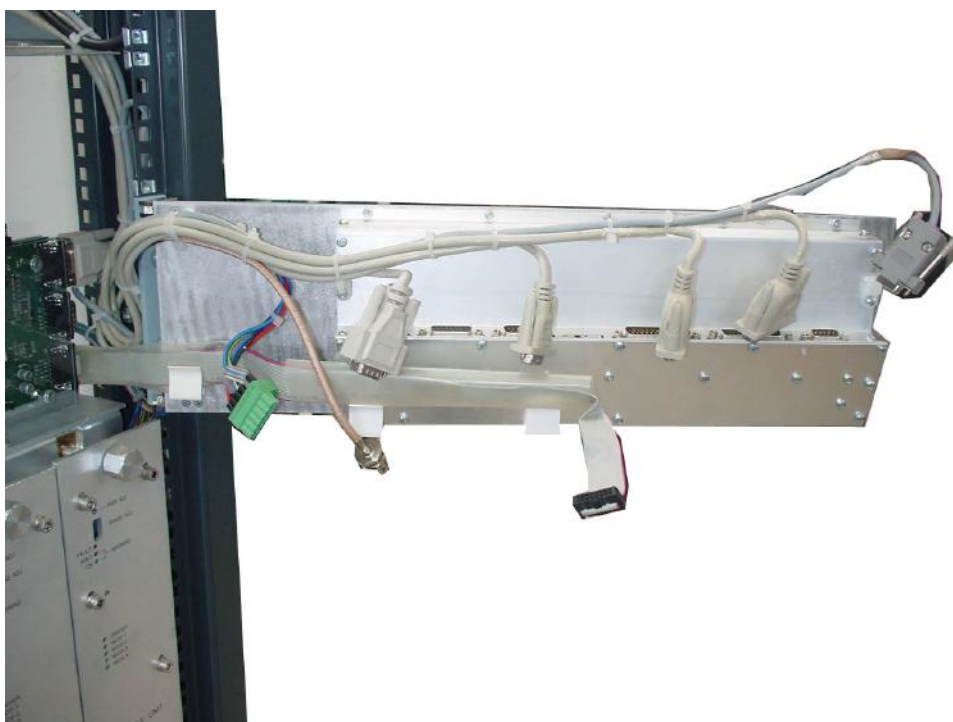

- 3) Unscrew the screws that fix the board to the rack and remove the panel from his place.



- 4) Connect the three connectors precedentely identified to the entries of the board, like represented in the photo.

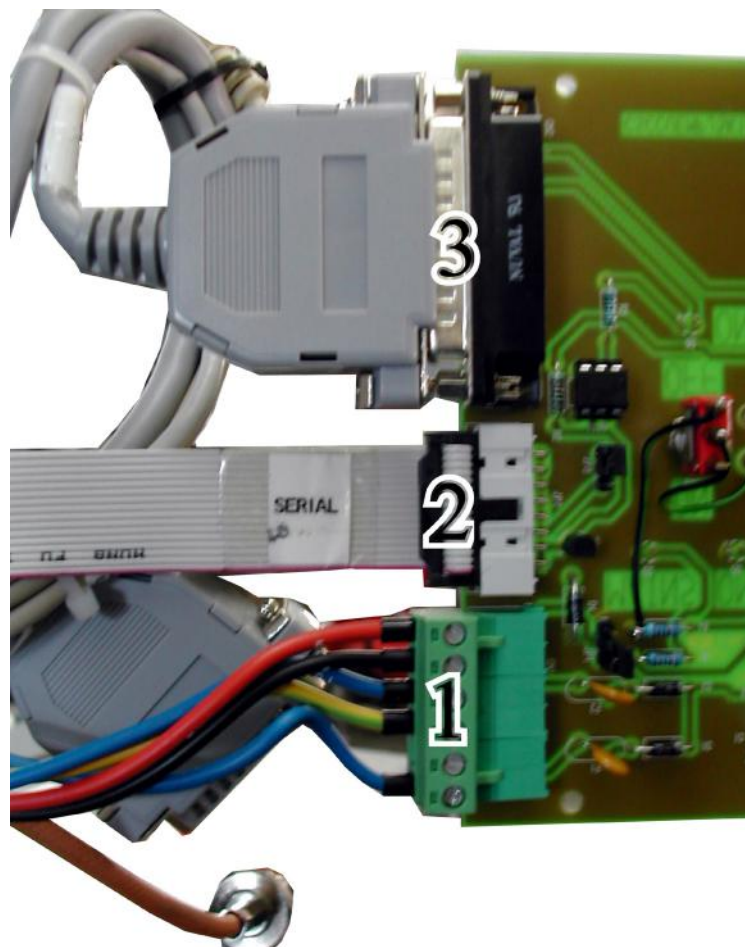

5) Fix the board to the rack, in the same position in which previously had fixed the central panel of control. Pay attention to fix the side of the card from which the interrupter sticks out toward the outside of the amplifier.

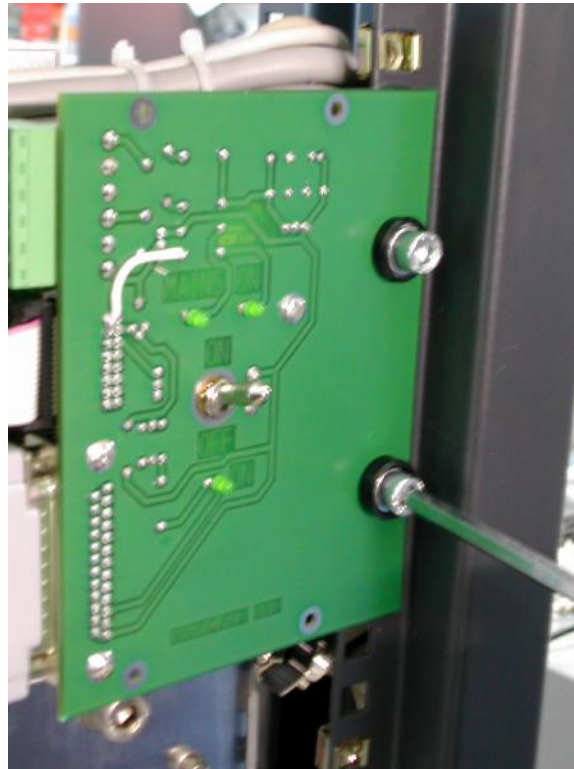

6) Switch-ON the transmitter with general switch and activate the operation of the board putting the interrupter on the ON position. The switch has built in way to avoid the accidental operating; throw the interrupter toward the outside, go on the desired position and release the interrupter.

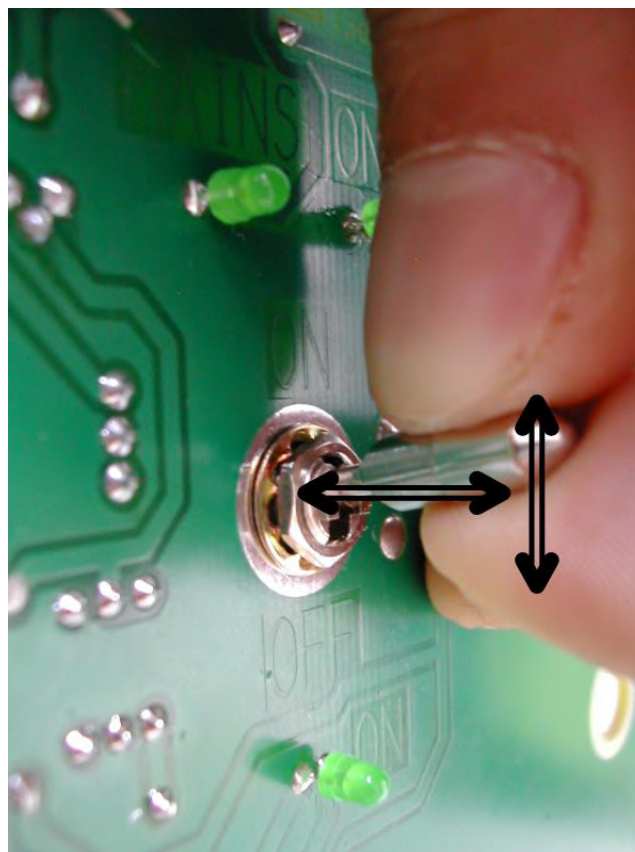

Now the emergency board is operative.

When we use the emergency board, the amplifier acts with the parameters previously adjusted (for example: the level of power). To modify the parameters is necessary use the unit control.

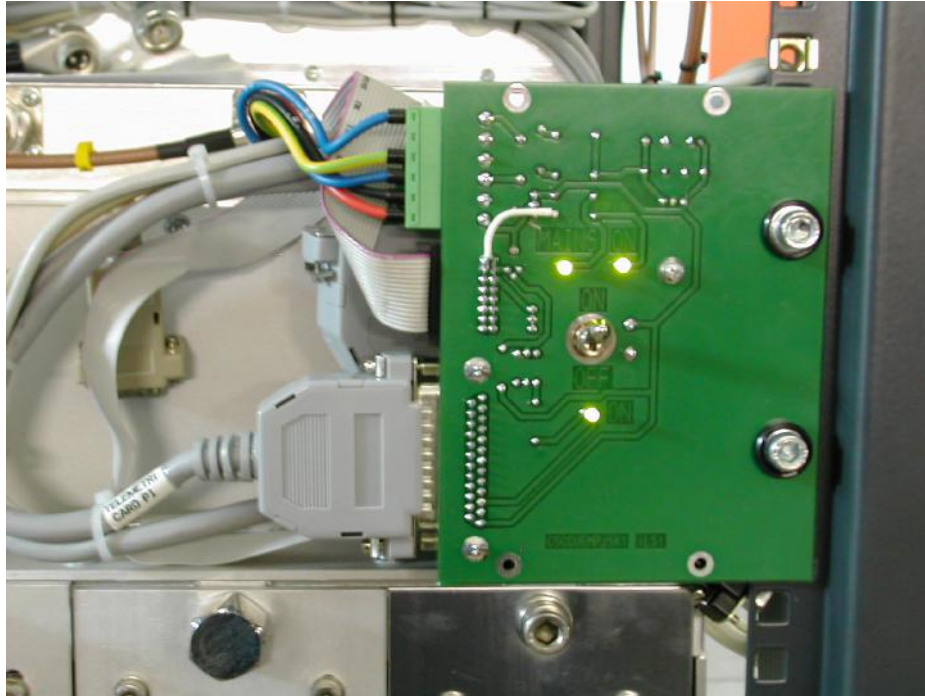

6.8 Services supply

The services of PJ6KPS-CA are supplied at 230V through a dedicated transformer.

Between the services, are included the microcontroller cards of RF modules, those of the combiner and power supply and the control unit.

Supplying the services of the PJ6KPS-CA with an UPS (Uninterruptable Power Supply), the transmitter also in case of absence of mains power can be managed, naturally limitedly to the functions available (for example configuration or interrogation of the alarms registry). The normal configuration of the transmitter previews that the services are directly supply through the connection to the electrical mains of the transmitter, in order to insert an UPS is sufficient put it between the VDE on the roof, after have removed the bridge that comes supplied of series.



6.9 PJ6KPS-CA Ventilation

The input hole of the air is situated on the back cover of the rack.

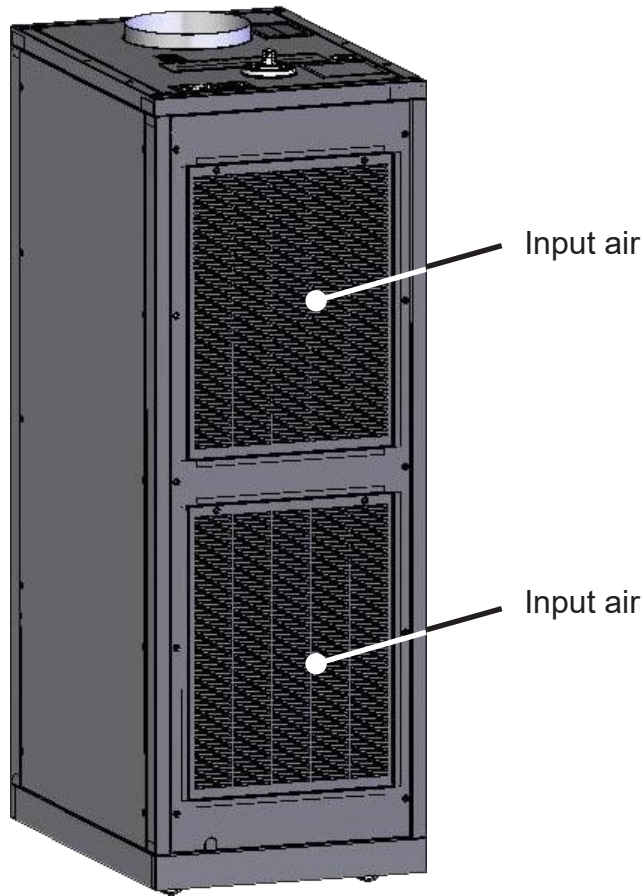

The output hole of the air is situated on the top cover of the rack.

The current of output air is equal to 800 m³/ h. The diameter of the output is 300mm.

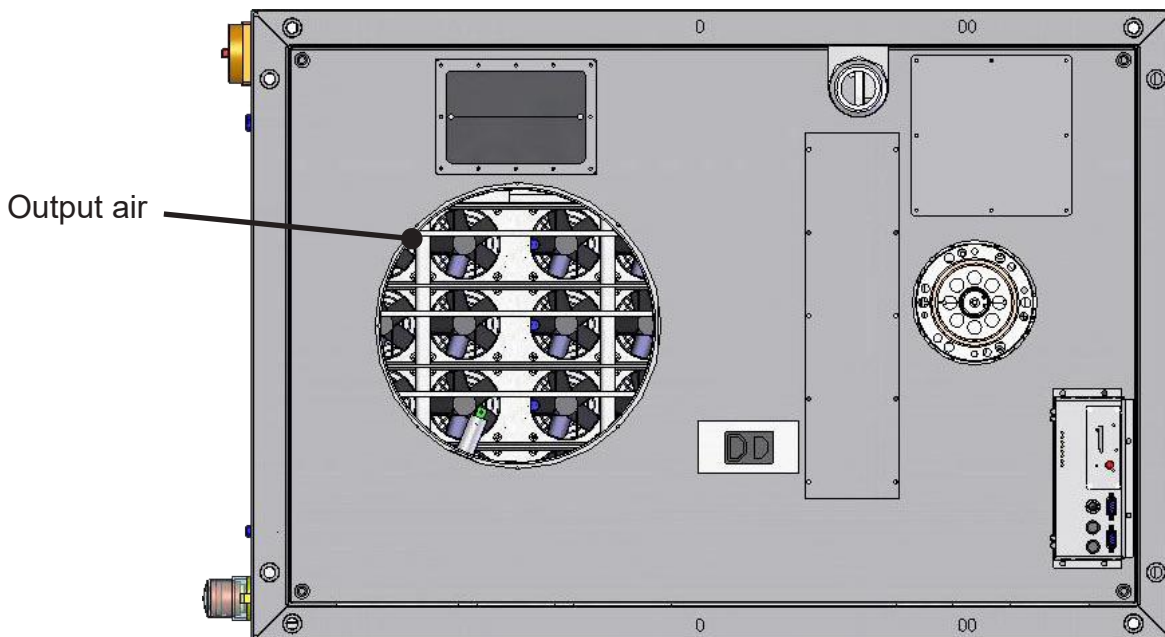

6.10 Input socket

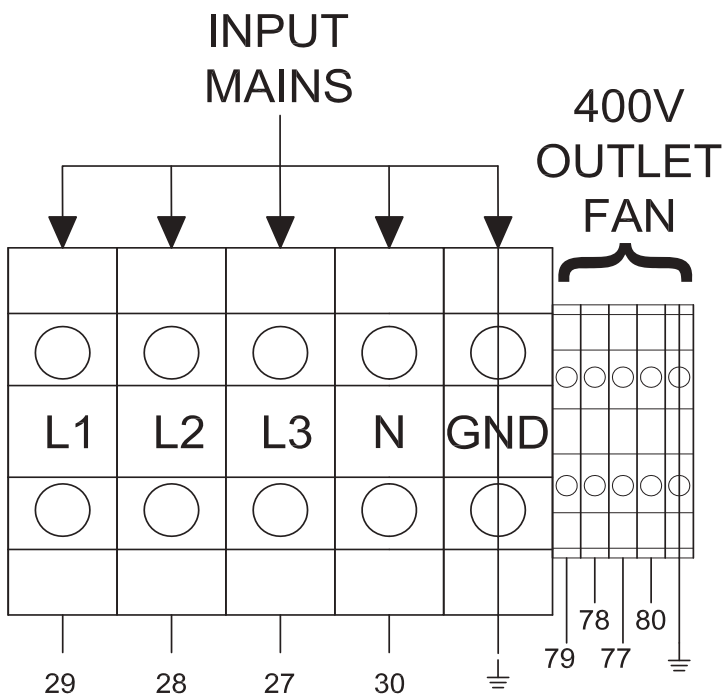

THREEPHASE
VERSION
(400 V)

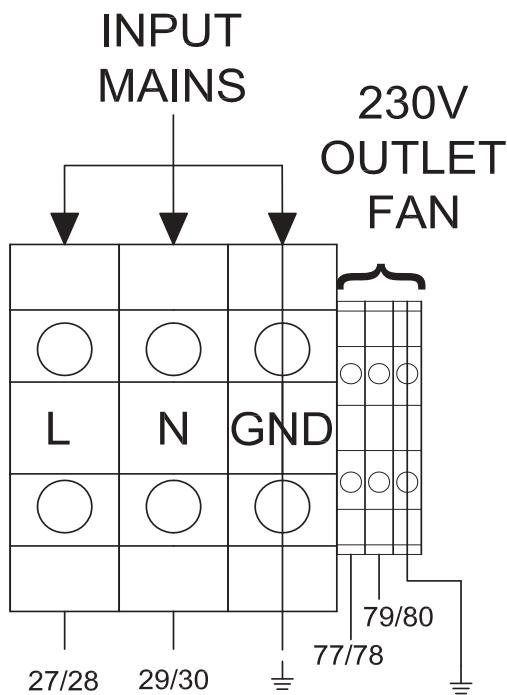

MONOPHASE
VERSION
(230 V)

		DENOMINAZIONE: Input socket	
		N° PROGRAMMA	MACCHINA
SEMILAVORATO: ---		AUTORE Nicolini Daniele	
MATERIALE: ---		PESO [kg] 0.65	CODICE DISEGNO
TRATTAMENTO: ---		DATA 14/10/2014	REVISIONE 1
TOLLERANZA GENERALE SECONDO UNI ISO 2768-f		FORMATO A4	()

6.11 Rejected load

INSIDE VIEW

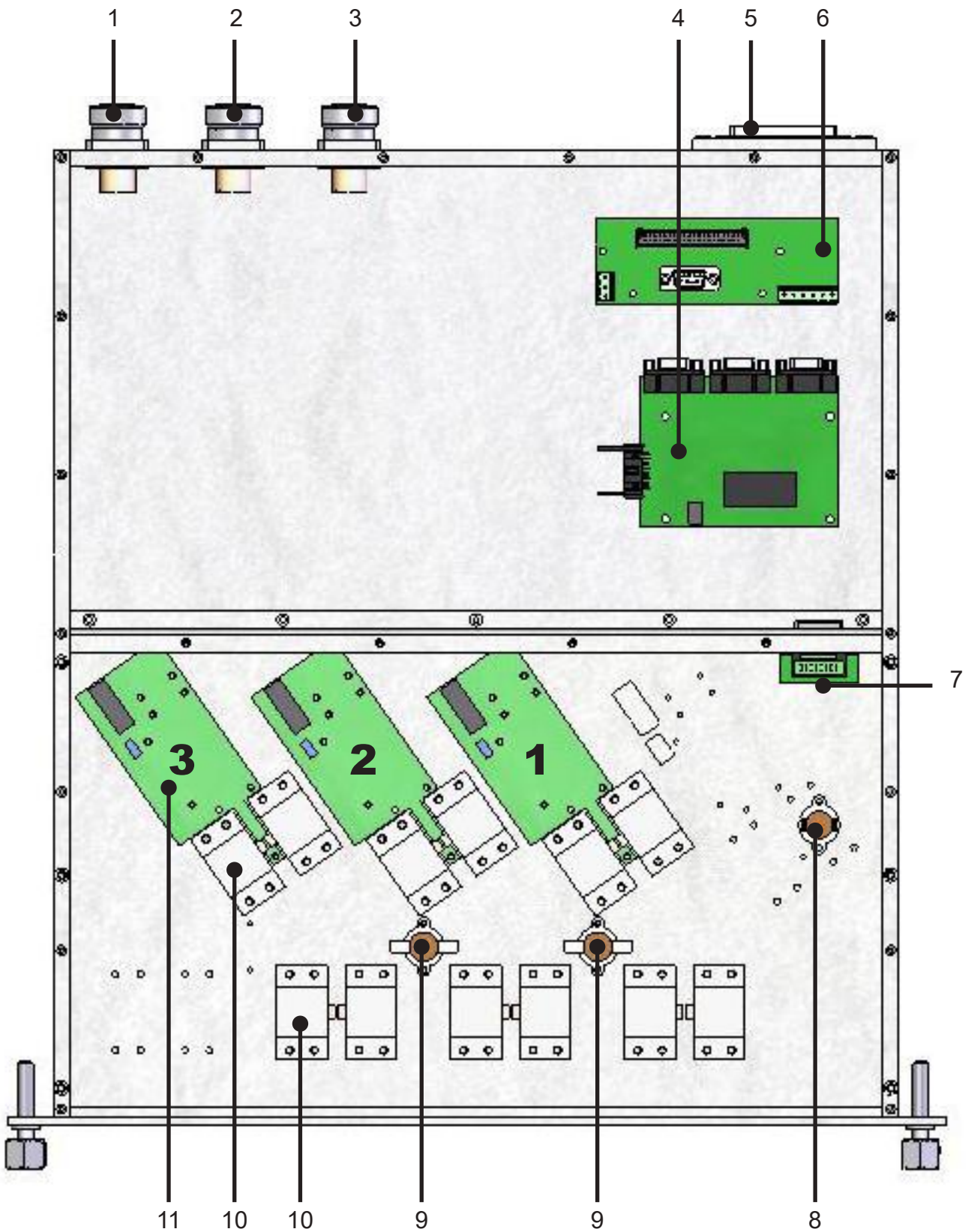

N°	Description	Code	Technical Annex page
1	Input 3 RF (7/16") to KDI 3	/	/
2	Input 2 RF (7/16") to KDI 2	/	/
3	Input 1 RF (7/16") to KDI 1	/	/
4	Absorber measure board	SLADKDIPK5K3	105
5	DB-37 connector	/	/
6	Dummy load interface	SLIORFPJ6KCV	109
7	DB-15 connector	SLDB15FMOD2K	/
8	Temperature sensor 120°C (NC)	SETBIMET120NC	/
9	Temperature sensor 50°C (NA)	SETBIMET50NA	/
10	KDI resistor 100 Ω 800 W (termination)	RDT800J0100	/
11	Unbalancement measure board	SLPWRSEBHC52	108

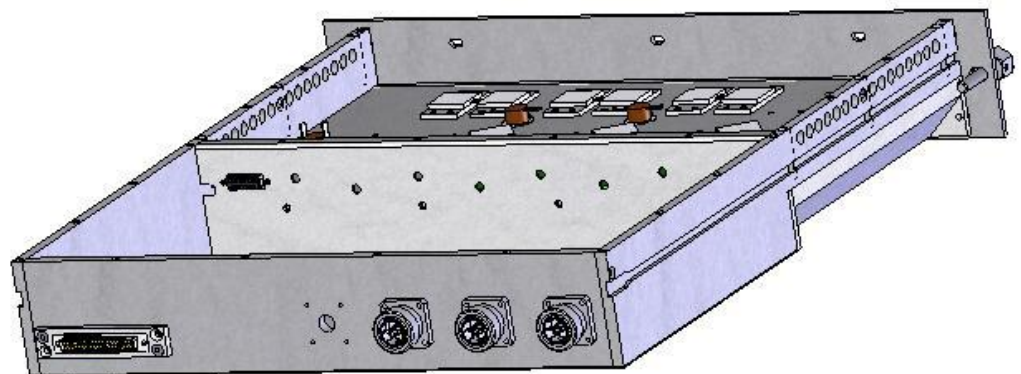
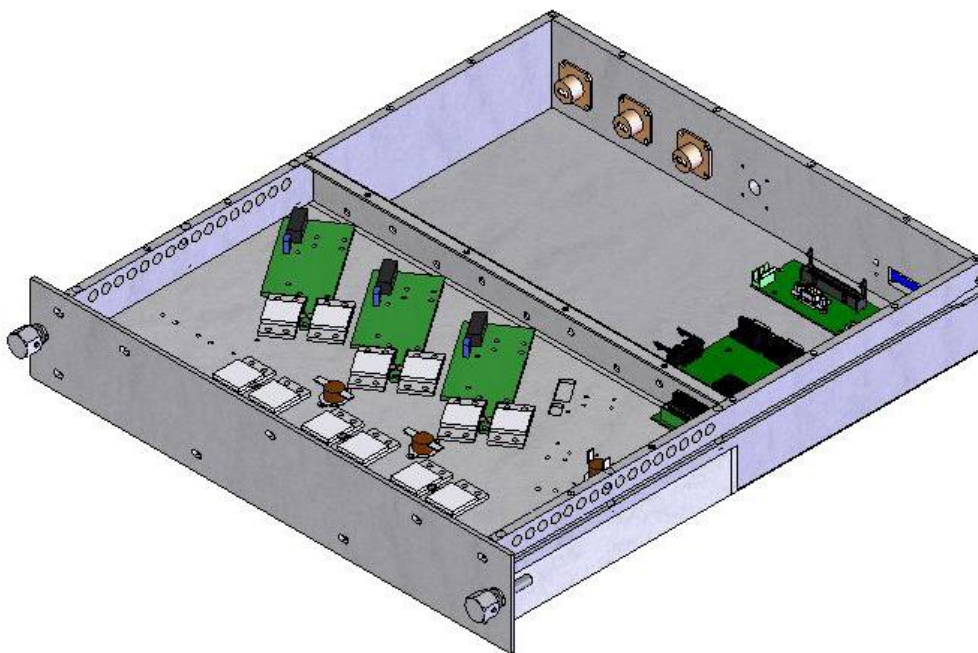

6.11.1 Wiring diagrams

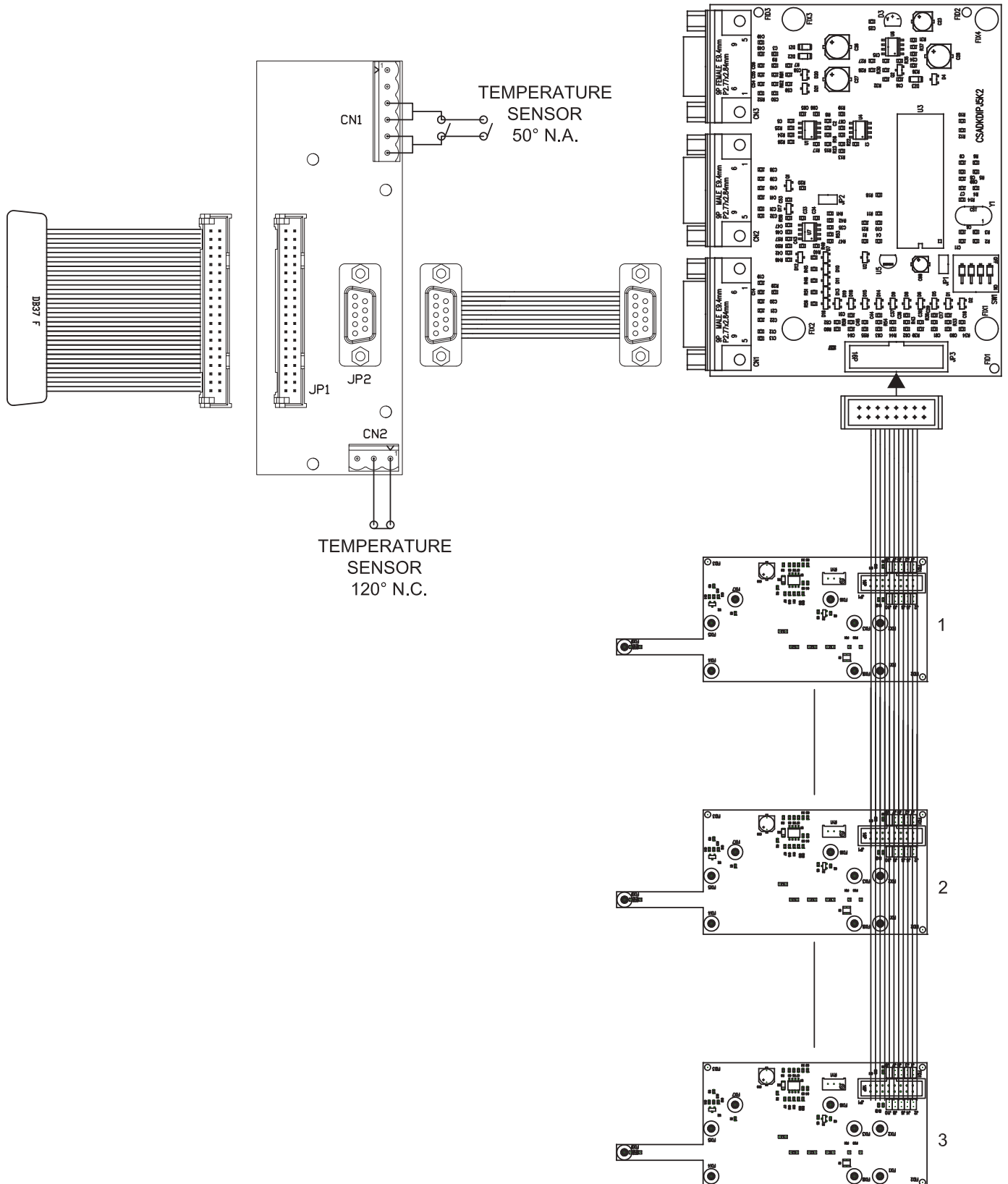

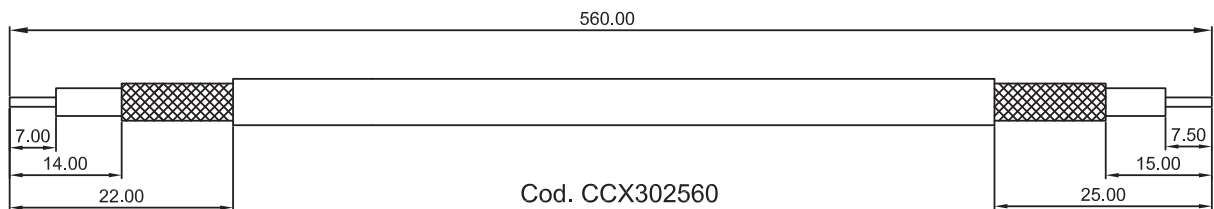
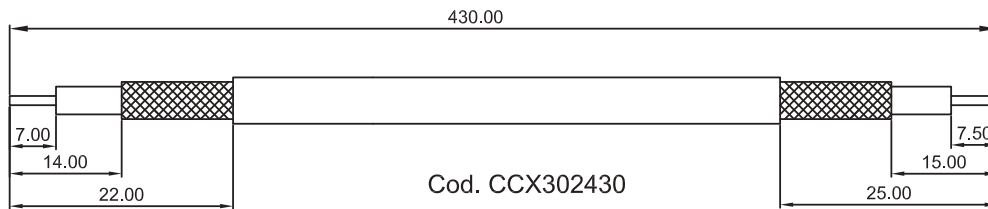
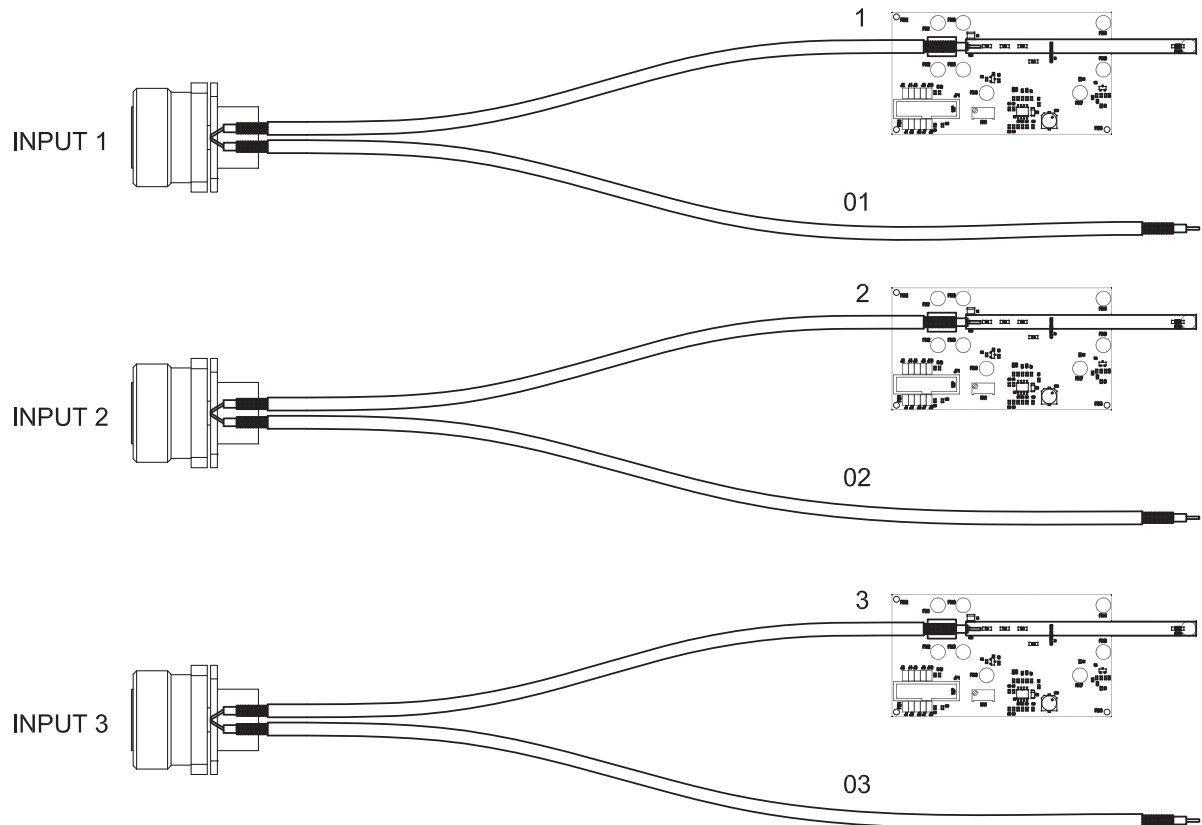

6.11.2 Settings Absorber measure board

To make sure they are configured correctly you have to set them through the switch SW1 and jumper JP2.

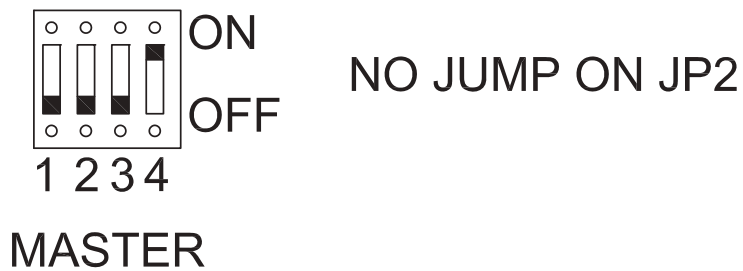
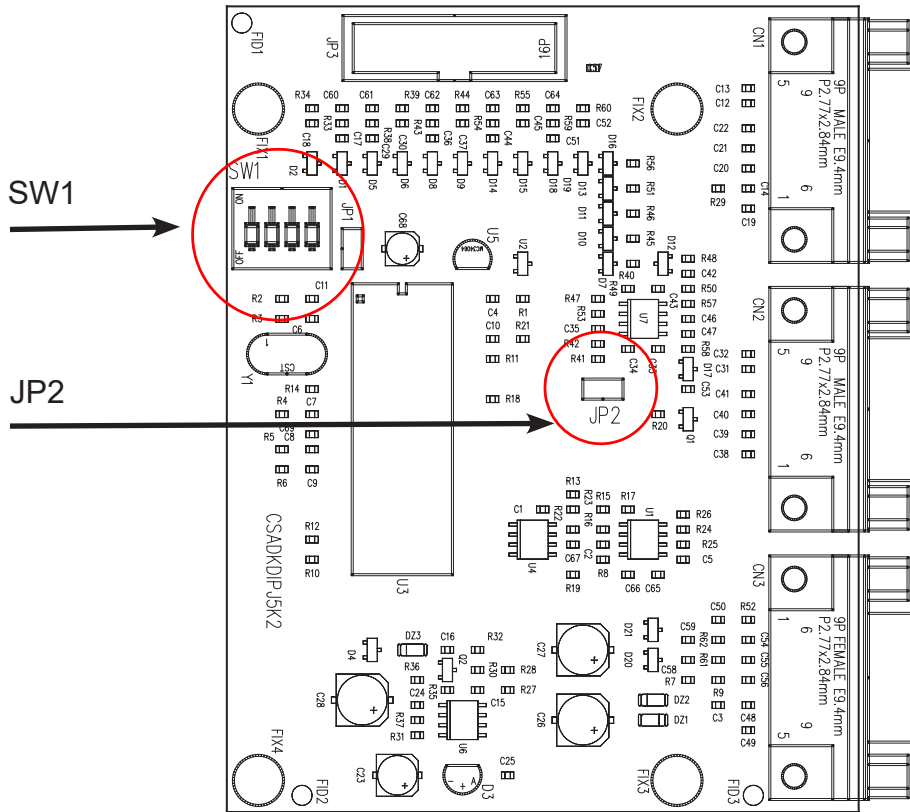

6.11.3 Settings Unbalancement measure board

To make sure they are configured correctly, you must set address of each board.

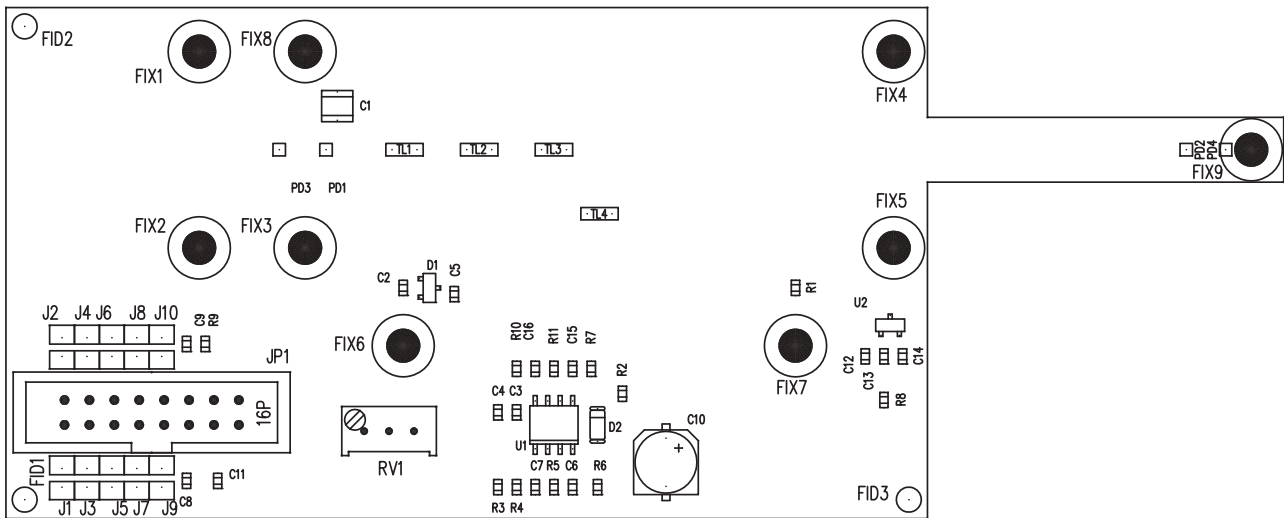

↑ Address

You have to make a jumper, with tin on:

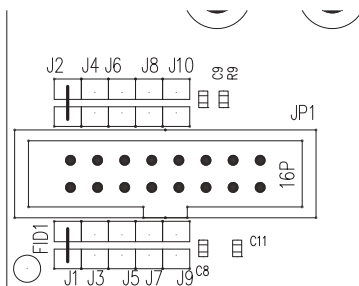

J1 and J2 for board 1

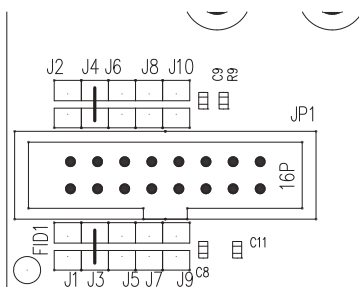

J3 and J4 for board 2

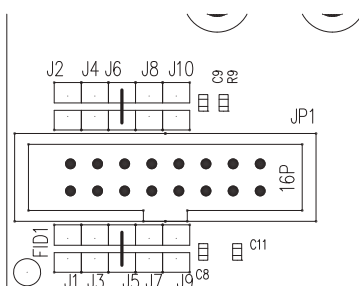

J5 and J6 for board 3

6.12 Lightning current arresters

Combined Arresters – Type 1	Lightning Current Arresters – Type 1	N-PE Lightning Current Arresters – Type 1	Surge Arresters – Type 2	Surge Arresters – Type 3	Accessories
-----------------------------	--------------------------------------	---	--------------------------	--------------------------	-------------

POWER SUPPLY SYSTEMS

DEHNbloc®

LIGHTNING CURRENT ARRESTERS – TYPE 1

DEHNbloc ... 255 H

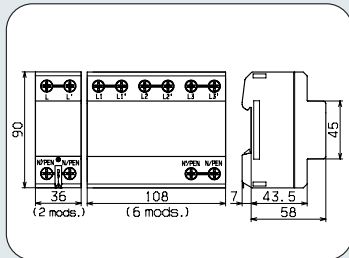

Dimension drawing DB 1 255 H / DB 3 255 H

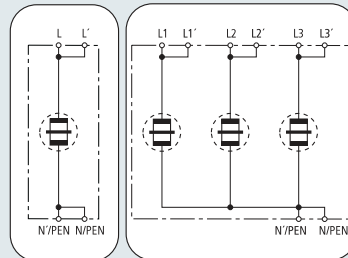

Basic circuit diagram DB 1 255 H / DB 3 255 H



DB ... 255 H: Single-pole and 3-pole lightning current arrester with high follow current limitation

	DB 1 255 H	DB 3 255 H
SPD according to EN 61643-11	Type 1	Type 1
SPD according to IEC 61643-1	Class I	Class I
Nominal a.c. voltage U_N	230 V	230/400 V
Max. continuous operating a.c. voltage U_C	255 V	255 V
Lightning impulse current (10/350 μ s) I_{imp}	50 kA	—
Lightning impulse current (10/350 μ s) [L-N/PEN] I_{imp}	—	50 kA
Lightning impulse current (10/350 μ s) [L1+L2+L3-N/PEN] I_{total}	—	100 kA
Nominal discharge current (8/20 μ s) I_n	50 kA	50 / 100 kA
Voltage protection level U_p	≤ 4 kV	≤ 4 kV
Follow current extinguishing capability a.c. I_{fi}	50 kA _{rms}	50 kA _{rms}
Follow current limitation / Selectivity	no tripping of a 32 A gL/gG fuse up to 50 kA _{rms} (prosp.)	no tripping of a 32 A gL/gG fuse up to 50 kA _{rms} (prosp.)
Response time t_A	≤ 100 ns	≤ 100 ns
Max. backup fuse up to $I_K = 50$ kA _{rms} ($t_a \leq 0.2$ s)	500 A gL/gG	500 A gL/gG
Max. backup fuse up to $I_K = 50$ kA _{rms} ($t_a \leq 5$ s)	315 A gL/gG	315 A gL/gG
Max. backup fuse for $I_K > 50$ kA _{rms}	200 A gL/gG	200 A gL/gG
Max. backup fuse (L-L)	125 A gL/gG	125 A gL/gG
Temporary overvoltage (TOV) U_T	335 V / 5 sec.	335 V / 5 sec.
Operating temperature range (parallel connection) T_{UP}	-40°C...+80°C	-40°C...+80°C
Operating temperature range (series connection) T_{US}	-40°C...+60°C	-40°C...+60°C
Cross-sectional area (L, L', N/PEN, N/PEN) min.	10 mm ² solid/flexible	—
Cross-sectional area (L, N/PEN) max.	50 mm ² stranded/35 mm ² flexible	—
Cross-sectional area (L', N/PEN) max.	35 mm ² stranded/25 mm ² flexible	—
Cross-sectional area (L1, L1', L2, L2', L3, L3', N/PEN, N/PEN)	—	10 mm ² solid/flexible
Cross-sectional area (L1, L2, L3, N/PEN)	—	50 mm ² stranded/35 mm ² flexible
Cross-sectional area (L1', L2', L3', N/PEN)	—	35 mm ² stranded/25 mm ² flexible
For mounting on	35 mm DIN rail according to EN 60715	35 mm DIN rail according to EN 60715
Enclosure material	red thermoplastic, UL 94 V-0	red thermoplastic, UL 94 V-0
Degree of protection	IP 20	IP 20
Dimension	2 mods., DIN 43880	6 mods., DIN 43880
Approvals, Certifications	KEMA	KEMA
Ordering information		
Type	DB 1 255 H	DB 3 255 H
Part No.	900 222	900 120
Packing unit	1 pc(s).	1 pc(s).

Combined Arresters – Type 1

Lightning Current Arresters – Type 1

N-PE Lightning Current Arresters – Type 1

Surge Arresters – Type 2

Surge Arresters – Type 3

Accessories

DEHNgap

DEHNgap M 255 (FM)

POWER SUPPLY SYSTEMS

N-PE LIGHTNING CURRENT ARRESTERS

NEW

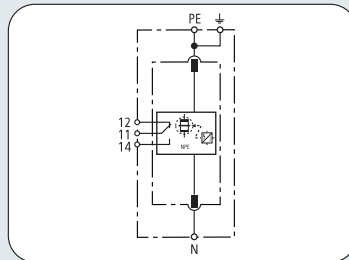

Basic circuit diagram DGP M 255 FM

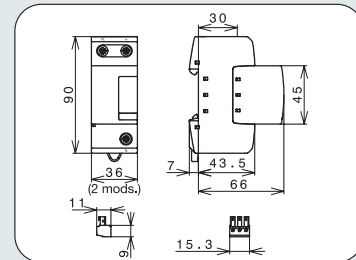

Dimension drawing DGP M 255 FM

DGP M 255 (FM): Single-pole, modular coordinated N-PE lightning current arrester for $U_C = 255 V$; also available with remote signalling contact for monitoring system (floating changeover contact)

	DGP M 255	DGP M 255 FM
SPD according to EN 61643-11	Type 1	Type 1
SPD according to IEC 61643-1	Class I	Class I
Max. continuous operating a.c. voltage U_C	255 V	255 V
Lightning impulse current (10/350 μs) I_{imp}	100 kA	100 kA
Nominal discharge current (8/20 μs) I_n	100 kA	100 kA
Voltage protection level U_p	≤ 1.5 kV	≤ 1.5 kV
Follow current extinguishing capability a.c. I_{ff}	100 A_{rms}	100 A_{rms}
Response time t_A	≤ 100 ns	≤ 100 ns
Temporary overvoltage (TOV)	1200 V / 200 ms	1200 V / 200 ms
Operating temperature range (parallel connection) T_{UP}	-40°C...+80°C	-40°C...+80°C
Operating temperature range (series connection) T_{US}	-40°C...+60°C	-40°C...+60°C
Operating state/fault indication	green / red	green / red
Cross-sectional area (N, PE, \pm) min.	10 mm ² solid/flexible	10 mm ² solid/flexible
Cross-sectional area (N, PE) max.	50 mm ² stranded/35 mm ² flexible	50 mm ² stranded/35 mm ² flexible
Cross-sectional area (\pm) max.	35 mm ² stranded/25 mm ² flexible	35 mm ² stranded/25 mm ² flexible
For mounting on	35 mm DIN rail according to EN 60715	35 mm DIN rail according to EN 60715
Enclosure material	red thermoplastic, UL 94 V-0	red thermoplastic, UL 94 V-0
Degree of protection	IP 20	IP 20
Dimension	2 mods., DIN 43880	2 mods., DIN 43880
Type of remote signalling contact	—	changeover contact
Switching capacity a.c.	—	250 V/0.5 A
Switching capacity d.c.	—	250 V/0.1 A; 125 V/0.2 A; 75 V/0.5 A
Cross-sectional area for remote signalling terminals	—	max. 1.5 mm ² solid/flexible
Ordering information		
Type	DGP M 255	DGP M 255 FM
Part No.	961 101	961 105
Packing unit	1 pc(s).	1 pc(s).

Accessory Part for DEHNgap

NEW



DGP M – 100 kA N-PE Spark-gap-based protection module

DGP M MOD ...: 100 kA N-PE Spark-gap-based protection module for use with all modular DEHNgap M devices

Type	PU pc(s)	Part No.
DGP M MOD 255	1	961 010

7 Unpacking, installation and use

This chapter contains the basic instructions for installing and using the PJ6KPS-CA amplifier. If necessary, more in-depth information about the operating principles may be traced in the next chapters.

7.1 Assembly

For practical reasons and for transport safety, the transmitter is usually supplied disassembled to the customer. The assembly procedure is rather simple and can be carried out by any qualified technician.



Caution: In order to avoid the risk of damaging the transmitter and/or of injuring the operators, it is advisable to closely adhere to the instructions provided below. always respect all the safety regulations and standards in force.

Identify the transmitter components:

- The rack (various components are assembled, such as the coupler, the splitter, the control unit, the main blower) [Figure 5-1 a)]
- The Rejected load [Figure 5-1 b)]
- The 3 RF modules [Figure 5-1 c)]
- The exciters [Figure 5-1 d)]. (As a rule the amplifier is supplied as a complete transmitter. This example shows two PTXLCD exciters produced by R.V.R. Elettronica. Usually the exciters are pre-assembled inside the rack).

Check that all the components are in perfect working order. Should there be any kind of problem, for instance if there is any damage caused by the transport of the components, read the instructions associated with the Warranty at the beginning of this manual (chapter 2).

1. Install the rack in the location where the transmitter will work. The rack is mounted on wheels for simplifying its movement, therefore after having positioned it where expected, it is advisable to use the four screws at the bottom of the rack to steady it perpendicular to the ground.

The transmitter is cooled by forced ventilation. The air outlet is on the transmitter's roof whereas in the standard configuration the air intake is envisaged at the back of the transmitter. If you opt for this solution, install the transmitter at least 50 cm. away from the back wall, so that air can flow under optimal conditions.

2. Remove the protection panels of the RF modules .

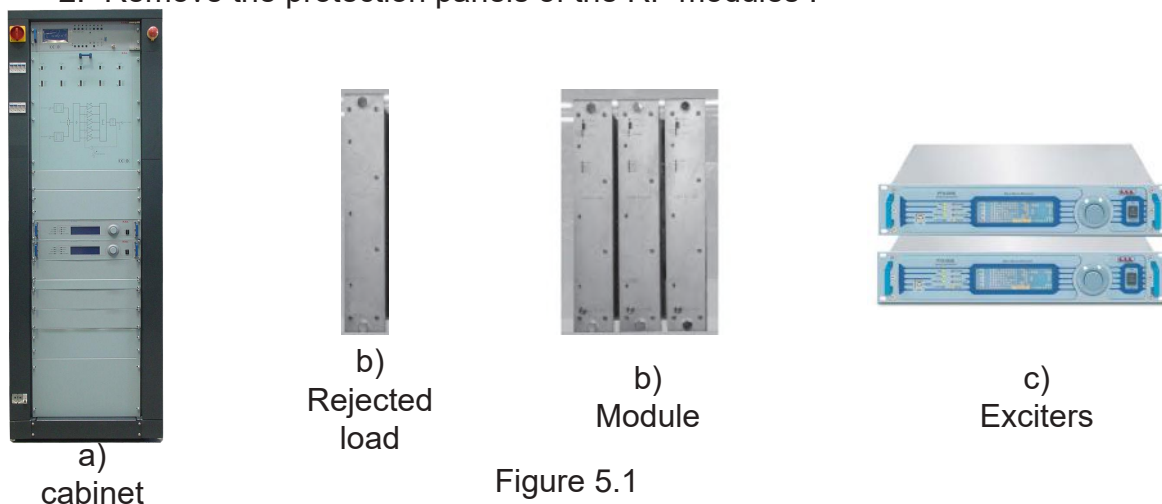

Figure 5.1

- 3 Insert the rejected load in the first compartment and then the amplifying modules [Figure 5-2].

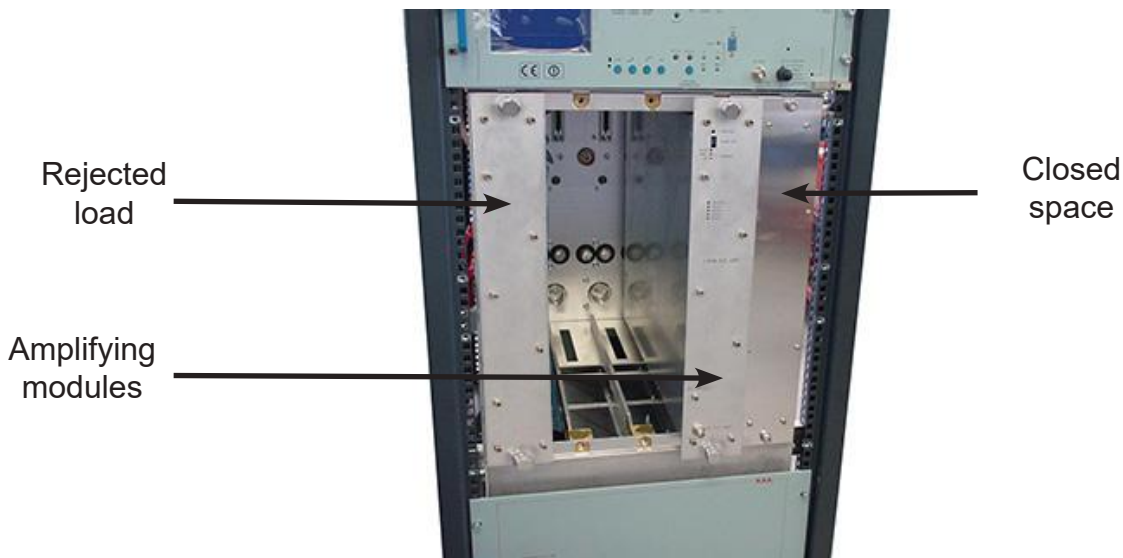

Figure 5.2

The modules have a groove at the top and one at the bottom: insert the modules so that the guides in the compartment fit into these grooves. Slide the module until the two fixing screws fit into their seats. Then tighten the fixing screws at the same time so that the module inserts into its compartment remaining parallel until it is perfectly in place.

4. Connect the transmitter's main power supply cable. Route the cable (5-pole type) through the raceway on the transmitter's roof [Figure 5-5 a)] and fix the conductors to the terminals of the top [Figure 5-5 b)].



Figure 5.5a
(On top)

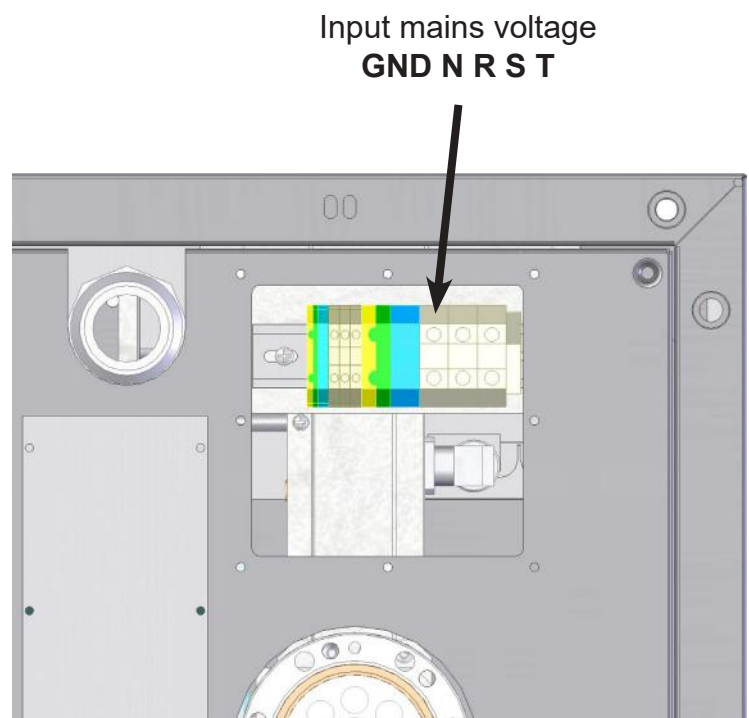
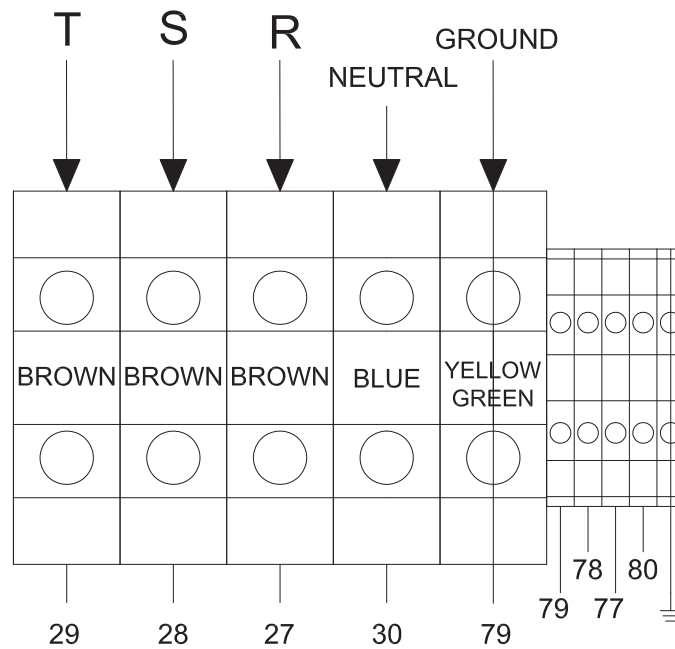

Figure 5.5b
(Top view)



Caution: The connection of the transmitter to the electric alimention is performed fixing to a 5 poles cable with bare terminals to a terminal block. Making sure without any possibility of error that the cable is not under tension while working on it. It is reccomended not to turn on the transmitter without first have connected the RF exit to the antenna or to the dummy load! The PJ6KPS-CA requires a three power supply 3F (black, brown and grey) + N (blue) + GND (green yellow) able to give 50A for phase. Keep this requirement in mind in connecting to the personal distribution board.

5. Reposition the protection panels of the RF modules.
6. If the PJ6KPS-CA was not supplied complete with pre-assembled exciters, insert and connect the exciters into the appropriate housings.

7.2 First start

This section describes the procedure for powering-on the transmitter the first time. For simplicity's sake, the automatic control capacities of the exciters are temporarily disabled.

7.3 Preliminary operation

Before activating this piece of equipment, the necessary connections must be performed, and in particular:

- Power supply (MUST BE EQUAL TO WHICH HAS BEEN DESIGNED THE Transmitter, OTHERWISE YOU MIGHT PERMANENTLY DAMAGE, **R.V.R. ELETTRONICA S.r.l. DOESN'T ASSUME RESPONSIBILITY.**)
- Modulating signals
- RF load (antenna feeder or dummy load).

The transmitter's RF output is the 1+5/8" or 3 1/8" EIA flanged type and is accessed on the roof of the PJ6KPS-CA. If a dummy load capable of dissipating the RF power generated by the transmitter is available, it is advisable to run the first tests by connecting to it rather than to the transmission antenna.

7.4 Power-on

When powering-on the transmitter the first time, perform the operations outlined in the table below.

The “Result” column indicates the immediate results of the operations performed plus a few indications that confirm that the transmitter is working efficiently.

Should any inconsistencies occur as compared to these indications, interrupt the procedure and identify the reason for the malfunction before resuming the procedure.

Operation	Result
Turn the “Mains” switch	The whole transmitter is powered. The transmitter is activated in the same status it was in when it was turned off the last time. • Check in the menu “Power supply” > ”Mains” if ALARM, overthrow RST phases, because the sequence is not correct, therefore don’t start the boot sequence of the transmitter. • Check in the menu “Power supply” > ”Safety” if ALARM means that the emergency button is pressed.
Press the OFF key of the control unit	RF emission by the transmitter is inhibited; the exciters are off; the RF amplifier modules are off
Press the EXCITER CHANGEOVER key of the control unit	The automatic management for the exciters changeover is disabled. The MANUAL LED must be on (otherwise press the key again)
Press the STDBY key of the control unit	The exciters are turned on in interlock status. The RF amplifying modules stay disabled. Being in manual modality, the exciters could be unlocked to verify the operation (see 7.5).
Set the parameters of the control unit	This procedure is described in chapter 5 on in this manual. The control unit communicates the nominal power and reduced power values to the RF modules. It also handles the coaxial relays so that the on air exciter is the desired one and sets the exciter to ON mode
Set the exciters	Adhere to the instructions of the exciters used for setting the required work frequency on the exciters. Regulate the output power of the exciters to 20/22 W.
Press POWER LOWER and ON	The current exciter is activated (the interlock is released from the exciter) and its power emission is enabled. The power emitted by the PJ6KPS-CA amplifier increases gradually until it attains the level that had been set previously as “Reduced power”. Check the emitted power level on LCD display.
Press NOMINAL POWER	Power supplied by PJ6KPS-CA increases and attains the set nominal value. Check it on the analog instrument.

When the transmitter is on and works at its nominal power, the whole series of “accessory” checks and settings deemed necessary may be carried out before starting up the transmitter.

7.5 Control unit settings

The settings of the control unit that are required for starting up the transmitter, mentioned in the powering-on procedure, are the following:

1. Setting of the power levels
2. Setting of the on air exciter

Before performing the first operation, click the ESC and OK button. The display shows the screenful for selecting the menus [Figure 5-7]. Click the arrow keys until the cursor highlights the line associated with the Setting menu. Click OK: the software will show the associated screenful on the display [Figure 5-8].

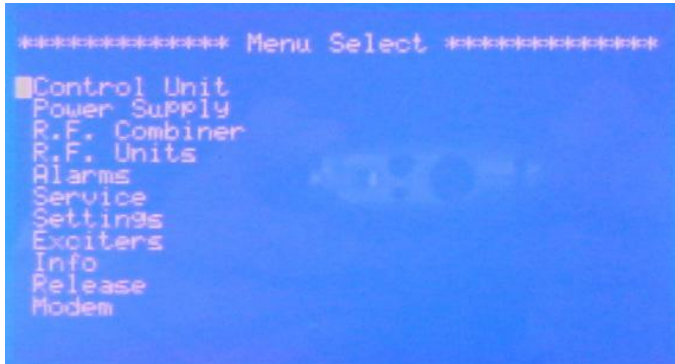

Figure 5-7



Figure 5-8

On having accessed the Settings menu, use the arrow keys to select the nominal power line (Pwr. Out) and click OK. Use the arrow keys to decrease or increase the indicated percentage value up to the required level. Click OK again to set this value. Repeat the operation for the line associated with the reduced power level (Pwr. Lower).



The new power level is transmitted to the combiner module and then stored in EEPROM only when the ESC button is clicked.

When inside this menu, it is advisable to check the date and time lines and update them if necessary. Note: the date and time are used only for marking the events in the alarms register.



The date and time do not need to be updated in the transmitter in order for it to work efficiently.

On having completed these settings, click ESC to return to the selection screenful.

In order to set the on air exciter, select the Exciters menu [Figure 5-9]. Take into consideration the On Air Exciter line: the number to the right indicates the exciter being used. To change it simply highlight the line and click OK.

To have the correct efficiency of the transmitter, the exciters should stay at 20/22 W, unless stated otherwise indicated on the modulator, depending on the version and frequency. The power of the transmitter should be adjusted from the menu “Settings”.

DO NOT RESPECT THIS COULD DAMAGE THE EQUIPMENT
LD MOS, RVR ELETTRONICA S.R.L. DISCLAIMS THE WARRANTY.

The exchange of the exciters is assisted from the software, that is when the commutation is carried out, the interlock comes systematized in the correct way independently from like they were. The interlock could be modified also manually in case of necessity.

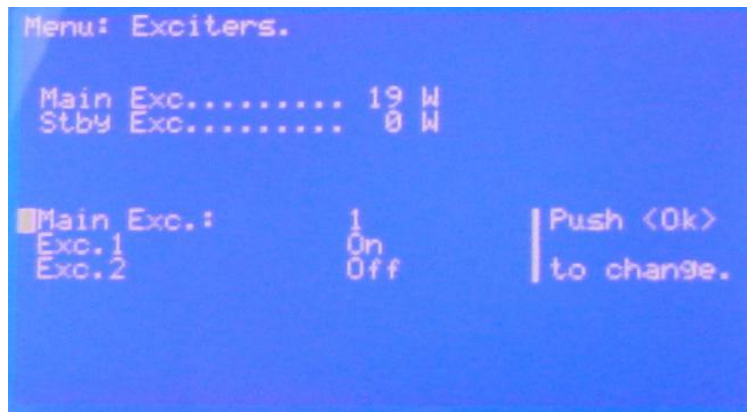

Figure 5-9

7.6 Management of the exciters

The control unit can perform the automatic changeover between exciters if one malfunctions. The Manual LED on the panel indicates, when it is lighted up, that the automatic changeover function is disabled. In order to enable it, click the EXCITER CHANGEOVER button and check that the LED turns off.

In function of the state of the PJ6KPS-CA automatism, the behavior of the transmitter will be various. In this chapter are described the different cases.

7.6.1 Start-up from power-on with exciters in manual mode

When powering on the transmitter with the exciters in manual mode, the transmitter does not perform any check, both mute RF signals are active and the changeover relay remains in standby status. Use the exciters menu to activate an exciter.



This is why, if the transmitter is left in manual mode, any momentary power failure will cause the transmitter to be inactive when turned on again. Therefore it is advisable to leave the PJ6KPS-CA in automatic mode when you are not performing maintenance operations.

7.6.2 From OFF to ON with exciters in manual

When switching from OFF (or STDBY) to ON with the exciters in manual mode, the transmitter does not perform any check and the exciter that is currently set to on air is the one that is aired.

If the mains signal is not OK, the exciters turn off automatically.

If the maximum drive power is exceeded during operations, the PJ6KPS-CA is set to fault status and power supply is cut to the exciters. A message in the alarms menu signals this fault.

When the transmitter is set to STDBY, the mute RF signals of the exciters are not activated and may be modified by the operator.

When the transmitter is set to EXT INT or AUX INT, the mute RF signals of the exciters are not activated and may be modified by the operator.

7.6.3 Automatic changeover

When the PJ6KPS-CA is in the exciter automatic changeover mode, the power emitted by the on air exciter is checked constantly. If at any time the on air exciter is no longer good (i.e. power drops to below the preset level), the transmitter is kept operational whereas the exciter connected to the internal Dummy Load turns on. If the latter one is good (i.e. it is capable of supplying the required power), then the two exciters are changed over. Instead if the alternative exciter is not good, no changeover takes place, the control unit commands the mute RF of the exciter to Dummy Load, it waits 120 s. and repeats the attempt. This procedure is repeated indefinitely until one of the two exciters is considered to be good.

During the whole length of time during which there is no good exciter, the PJ6KPS-CA keeps the WAIT LED on for signaling this status.

Each exciter is fitted with its own mute RF. On being commanded, the piloting signal must return to zero within 3 seconds at the most. If this does not occur, the fault is recorded by an error message that is entered in the alarms menu.

If the mains signal is not OK, the exciters turn off automatically. If the piloting power exceeds the limit during operations, the PJ6KPS-CA is set to the FAULT status and the power supply of the exciters is turned off. A message in the alarms menu signals the fault. Keep in mind that the operator's intervention is required to exit from the FAULT status.

If the MAINS signal coming from the bus is not OK, the exciters are all turned off. As soon as the MAINS signal is regular again, the evaluation cycle of the exciters begins (see 7.6.4).

When the transmitter is set to STDBY, the mute RF signals of the exciters are activated and as such both exciters are inhibited. If the ON key is pressed, the system re-evaluates both exciters in the same manner as in the procedure from OFF to ON (see 7.6.4).

When the transmitter is set to EXT INT or AUX INT, the mute RF signals of the exciters are activated and therefore both exciters are inhibited. When the external interlocks are released, the system re-evaluates both exciters as during the phase from OFF to ON (see 7.6.4).

7.6.4 Phase from ON to OFF

When the transmitter is set to OFF status and you press the ON button, the power supply of the exciters is activated and the logic starts to evaluate the exciters. During the evaluation phase, the WAIT LED stays ON.

When the transmitter is turned OFF, it memorizes the exciter on air. Consequently when the transmitter restarts it can attempt to restore the previous conditions. On the transmitter restarting, if the exciter that is to be aired does not attain the preset power level whereas the spare one is operational, the transmitter performs the changeover when the evaluation time (120 s.) expires.

On the transmitter restarting, if both exciters do not attain the preset power level, the transmitter airs the one that had been present when the transmitter was turned off, after the evaluation time has expired.

7.6.5 Start-up with exciters in automatic mode

The sequence run by the PJ6KPS-CA, when the power supply is activated while it is already in ON status and the exciters are in automatic mode, is identical to the one run for switching from OFF to ON. The only difference is that a screenful displays the countdown for determining the fault of the exciters. During this phase the manual/automatic button is inhibited and in order to set the exciters to manual mode you must press the OFF button of the transmitter.

7.6.6 Audio alarm

The control unit of the PJ6KPS-CA can manage a fault signal, for each exciter, which normally has an “Audio Alarm” meaning. The control software of the PJ6KPS-CA does not intervene in triggering these signals since they must be checked by the exciters (or by any other connected devices).

The Audio Alarm signals are made up of two inputs for the logical signals on the parallel interface and on the “mute RF” command connector of the exciters.

The control unit manages these signals just like it manages the power good signals:

- Each “Audio alarm” signal is associated with its own exciter
- If the audio signal, associated with the exciter that is currently on air, enters an alarm status, the PJ6KPS-CA waits for the time configured in the exciter menu before it attempts the restoring operation
- If the audio of the aired exciter is still in alarm status on the elapsing of the aforesaid time interval, the control unit checks if the audio of the exciter on the dummy load is regular. In this case the changeover between the exciters is performed.

Observe the following differences as compared to the case in which power is missing:

- The management of the “Audio alarm” signals is not active during the start-up phase and during the switching phase from OFF to ON, but only when the exciters are working in automatic.
- In the standard configuration, the aforesaid sequence continues until the audio signal associated with one of the exciters becomes regular again. In the “N+1” configuration, the switching attempt is performed only twice, after which the PJ6KPS-CA enters the fault status.
- An Audio Alarm output is provided on the parallel interface: this signal is activated (with no delays) when the audio of the exciter that is currently on air is in alarm status.

7.6.7 Protection and alarms

The PJ6KPS-CA contains a complete protection and alarms system, both at the individual modules level and at the control unit level.

The modules are fitted with a micro-processor-based system that manages any malfunctions locally. The associated information is communicated to the control unit for displaying and storing the events and for the centralized management of the events that require it.

Certain LEDs of the PJ6KPS-CA panel are dedicated to the management of the alarms:

LED	Description
WARNING	This LED indicates a warning (something is not correctly working, but the amplifier is still working)
FAULT	This LED indicates a fault (the amplifier is shut off, the operator's intervention is required)
WAIT	This LED indicates the wait status (the amplifier is temporarily off, it will be restarted as soon as the reason that keeps it from working will be removed, or after a fixed amount of time depending on the reason of the intervention of the protection system)

The ALARM RESET button is used for resetting the alarms and restarting the transmitter.

A complete description of the alarms and protection system is given in chapter 5.3.

8 Troubleshooting

ANY PROBLEMS AT FIRST START:

1) DOES NOT TURN ON THE DISPLAY:

- Was not connected to the bridge VDE on the top
- Have not been properly connected the wires to the terminals of power supply 400Volt
- You have not activated the automatic of services

2) TURN ON THE LED WARNING:

- Check in the menu "Power supply" > "Mains" if ALARM, overthrow RST phases, because the sequence is not correct, therefore don't start the boot sequence of the transmitter.
- Check in the menu "Power supply" > "Safety" if ALARM means that the emergency button is pressed.

3) TURN ON THE LED FAULT:

- Check in the menu "Power supply" > "Alarms: C.B. Pwr Fan" if ALARM means that the circuit breaker of input air, on the electromechanical section is disconnected.

4) TRANSMITTER ON BUT THE MODULES ARE NOT POWERED BY 42 VOLTS DC:

- The breakers of each module are disabled, arming the breakers and see if you turn on the green LED on the front panel
- Check that there is not an interlock due to incorrect connection of the relay contact on the coaxial, or because of the relay mounted inverted

5) MODULES POWERED (GREEN LEDS ON), BUT IS NOT EMITTED POWER:

- Check:
 - exciter power, present?
 - the set value corresponds to the one on the card test?
 - exciter's power goes to TX or DUMMY LOAD inside? if it goes to the LOAD switch to TX

6) THE POWER COMES FROM THE TX BUT IMPOSES A LIMIT?

- Check RFL, if the power exceeds 1800W TX goes into foldback and imposes a limit on the power
- If the value of the RFL is greater than 500W, check the connection between the TX and the antenna or coaxial relay or filter or LOAD, which is not correct

7) THE OUTPUT POWER IS CORRECT, BUT NO SOUND?

- check if the input set to the modulator, corresponds to the signal at input

If you have any problem on power, you can contact: customerservice@rvr.it

Revision History

Date	Version	Reason	Editor
17/06/2014	1.0	First version	Nicolini D.
30/06/2014	1.1	Updating	Nicolini D.
06/11/2014	1.2	Updating	Nicolini D.
19/01/2018	1.3	Updating	Nicolini D.
09/05/2019	1.4	Updating	Nicolini D.

© Copyright 2014
R.V.R. Elettronica S.r.l.
Via del Fonditore 2/2c – 40138 Bologna Italia
Telephone: +39 051 6010506
Fax: +39 051 6011104
E-mail: info@rvr.it
Web: www.rvr.it

All rights reserved

Printed and bound in Italy. No part of this manual may be reproduced, memorized or transmitted in any form or by any means, electronic or mechanic, including photocopying, recording or by any information storage and retrieval system, without written permission of the copyright owner.



R.V.R. Elettronica S.r.l.

Via del Fonditore, 2 / 2c

Zona Industriale Roveri · 40138 Bologna · Italy

Phone: +39 051 6010506 · Fax: +39 051 6011104

e-mail: info@rvr.it · web: <http://www.rvr.it>

ISO 9001:2000 certified since 2000



The RVR Logo, and others referenced RVR products and services are trademarks of RVR Elettronica S.p.A. in Italy, other countries or both. RVR ® 1998 all rights reserved.
All other trademarks, trade names or logos used are property of their respective owners.