



PWRMETER-D1

USER MANUAL
VOLUME1



File Name: PWRMETER-D2_ING_1.1.indb

Version: 1.1

Date: 15/05/2014

Revision History

Date	Version	Reason	Editor
29/11/2013	1.0	First Version	J. H. Berti
15/05/2014	1.1	Technical Description upgrade	J. H. Berti

PWRMETER-D1 - User Manual
Version 1.1

© Copyright 2013 - 2014

R.V.R. Elettronica SpA

Via del Fonditore 2/2c - 40138 - Bologna (Italia)

Telephone: +39 051 6010506

Fax: +39 051 6011104

Email: info@rvr.it

Web: www.rvr.it

All rights reserved

Printed and bound in Italy. No part of this manual may be reproduced, memorized or transmitted in any form or by any means, electronic or mechanic, including photocopying, recording or by any information storage and retrieval system, without written permission of the copyright owner.

Declaration of Conformity

Hereby, R.V.R. Elettronica SpA, declares that this FM transmitter is in compliance with the essential requirements and other relevant provisions of Directive 1999/5/EC.





DECLARATION OF CONFORMITY

We, the undersigned,

Manufacturer's Name: **R.V.R. Elettronica SpA**

Manufacturer's Address: **Via del Fonditore 2/2c
Zona Ind. Roveri
40138 Bologna
Italy**

Certify and declare under our sole responsibility that the product:

Product Description: **Power Meter**

Models: **PWRMETER-D1**

Variants: **/**

when used for its intended purpose, is in compliance with the essential requirements and other relevant provisions of Directive 1999/5/CE "R&TTE", and therefore carries the "CE" mark.

The conformity assessment procedure referred in Article 10 and detailed in Annex III of Directive 1999/5/EC has been followed.

The following harmonized standard have been applied:

ElectroMagnetic Compatibility (3.1b): EN 301 489-1 V1.9.2 (2011-09) +
EN 301 489-11 V1.3.1 (2006-05)

Safety (3.1a): EN 60215 (1997-10) +
EN 60065 (2011-01)

The technical documentation is held at the location above, as required by the conformity assessment procedure.

Bologna, Italia, 20/06/2013

Ravagnani Stefano
Direttore Tecnico
R.V.R. Elettronica S.p.A.



Technical Description

PWRMETER-D1				
Parameters	Conditions	U.M.	Value	Notes
GENERALS				
Power Supply			100-240Vac 50-60Hz	
Consumption		W	< 5	
Reading Measure		W	On request	Not selectable
FWD and REFLECTED Power Rating		W	+ 10 dBm nominal Level at the Input of PWRMETER for Full Scala Reading	Measurementn Range selectable by Menü, RF reference adjustable with setting of the coupling of related probe of the RF Section Line
Phisical Dimensions		mm.	202 x 85 x 184 (Overall 483 x 132 x 188)	W x H x D
Overall Dimensions				
Weight		Kg.	2,2	complete with 19" panel
Operating Temperature		°C	from -10 to +50	
Operating Humidity		%	95% non condensing	
Operating Altitude		mt.	up to 3.000 MASL	
INPUTS				
Forward RF Input	Connector		BNC	
	Impedance	Ohm	50	
	Input Level / Adjust	dBm	10	
Reflected RF Input	Connector		BNC	
	Impedance	Ohm	50	
	Input Level / Adjust	dBm	10	
OUTPUTS				
Remote connector outputs	Relay Contact		80% FWD	max 0,5A 48V
	Relay Contact		50% FWD	max 0,5A 48V
	Relay Contact		50% RFL	max 0,5A 48V
	Relay Contact		2:1 SWR	max 0,5A 48V
	Relay Contact		50% IN3	max 0,5A 48V
	Relay Contact		50% IN4	max 0,5A 48V

Table of Contents

1. Preliminary Instructions	1
2. Warranty	1
3. First Aid	2
3.1 Treatment of electrical shocks	2
3.2 Treatment of electrical Burns	2
4. Unpacking	3
4.1 General Description	3
5. Quick guide for installation and use	5
5.1 Preparation	5
5.2 Operation	6
5.3 Management Firmware	7
6. External Description	7
6.1 Front Panel	19
6.2 Rear Panel	12
6.3 Connectors description	13
7. Technical Specifications	14
8. Working Principles	15
8.1 RF RMS rectifier card	15
8.2 Power meter interface card	15
8.3 Power Meter Display card	15
9. Module Identification	16
9.1 Top View	16

This page was intentionally left blank

IMPORTANT



The symbol of lightning inside a triangle placed on the product, evidences the operations for which is necessary gave it full attention to avoid risk of electric shocks.



The symbol of exclamation mark inside a triangle placed on the product, informs the user about the presence of instructions inside the manual that accompanies the equipment, important for the efficacy and the maintenance (repairs).

1. Preliminary Instructions

• General foreword

The equipment in object is to considering for uses, installation and maintenance from "trained" or "qualified" staff, they conscious of the risks connected to operate on electronic and electrical circuits electrical.

The "trained" definition means staff with technical knowledge about the use of the equipment and with responsibility regarding the own safety and the other not qualified staff safety place under his directed surveillance in case of works on the equipment.

The "qualified" definition means staff with instruction and experience about the use of the equipment and with responsibility regarding the own safety and the other not qualified staff safety place under his directed surveillance in case of works on the equipment.

 **WARNING:** The machine can be equipped with an ON/OFF switch which could not remove completely voltages inside the machine. It is necessary to have disconnected the feeding cord, or to have switched off the control panel, before to execute technical operations, making sure himself that the safety connection to ground is connected.

The technical interventions that expect the equipment inspection with circuits under voltage must be carry out from trained and qualified staff in presence of a second trained person that it is ready to intervene removing voltage in case of need.

R.V.R. Elettronica SpA doesn't assume responsibility for injury or damage resulting from improper procedures or practices by untrained/unqualified personnel in the handling of this unit.

 **WARNING:** The equipment is not water resistant and an infiltration could seriously compromise its correct operation. In order to prevent fires or electric shocks, do not expose the equipment to rain, infiltrations or humidity.

Please observe all local codes and fire protection standards during installation and use of this unit.

 **WARNING:** The equipment has to its inside exposed parts to risk of electric shock, always disconnect power before opening covers or removing any part of this unit.

Fissures and holes are supplied for the ventilation in order to assure a reliable efficacy of the product that for protect itself from excessive heating, these fissures do not have to be obstructed or to be covered. The fissures doesn't be obstructed in no case. The product must not be incorporated in a rack, unless it is supplied with a suitable ventilation or that the manufacturer's instructions are been followed.

 **WIRING:** This equipment can irradiate radio frequency energy and if it's not installed following the instructions contained in the manual and local regulations it could generate interferences in radio communications.

 **WIRING:** This device has a connection to ground on the power cord and on the chassis. Check that they are correctly connected.

Operate with this device in a residential ambient can cause radio disturbs; in this case, it can be demanded to the user to take adequate measures.

Specifications and informations contained in this manual are furnished for information only, and are subject to change at any time without notice, and should not be construed as a commitment by R.V.R. Elettronica SpA.

The R.V.R. Elettronica SpA assumes no responsibility or liability for any errors or inaccuracies that may appear in this manual, including the products and software described in it; and it reserves the right to modify the design and/or the technical specifications of the product and this manual without notice.

• **Warning regarding the use designated and the use limitations of the product.**

This product is an transmitter radio indicated for the audio broadcasting service in frequency modulation. It uses working frequencies that are not harmonized in the states of designated user.

The user of this product must obtain from the Authority for spectrum management in the state of designated user the appropriate authorization to use the radio spectrum, before putting in exercise this equipment.

The working frequency, the transmitter power, let alone other specifications of the transmission system are subject to limitation and defined in the authorization obtained.

2. Warranty

R.V.R. Electronics S.P.A. guarantees absence of manufacturing defect and the good operation for the products, within the provided terms and conditions.

Please read the terms carefully, because the purchase of the product or acceptance of order confirmation, constitutes acceptance of the terms and conditions.

For the last legal terms and conditions, please visit our web site (WWW.RVR.IT) wich may also be changed, removed or updated for any reason without prior notice.

Warranty will be void in cases of opened products, physical damage, misuse, modification, repair by unauthorised persons, carelessness and using the product for other purpose than its intended use.

In case of defect, proceed like described in the following:

- 1 Contact the dealer or distributor where you purchased the unit. Describe the problem and, so that a possible easy solution can be detected.

Dealers and Distributors are supplied with all the information about problems that may occur and usually they can repair the unit quicker than what the manufacturer could do. Very often installing errors are discovered by dealers.

- 2 If your dealer cannot help you, contact R.V.R. Elettronica and explain the problem. If it is decided to return the unit to the factory, R.V.R. Elettronica will mail you a regular authorization with all the necessary instructions to send back the goods;

- 3 When you receive the authorization, you can return the unit. Pack it carefully for the shipment, preferably using the original packing and seal the package perfectly. The customer always assumes the risks of loss (i.e.,

R.V.R. is never responsible for damage or loss, until the package reaches R.V.R. premises. For this reason, we suggest you to insure the goods for the whole value. Shipment must be effected C.I.F. (PREPAID) to the address specified by R.V.R.'s service manager on the authorization



DO NOT RETURN UNITS WITHOUT OUR AUTHORIZATION AS THEY WILL BE REFUSED

- 4 Be sure to enclose a written technical report where mention all the problems found and a copy of your original invoice establishing the starting date of the warranty.

Replacement and warranty parts may be ordered from the following address. Be sure to include the equipment model and serial number as well as part description and part number.



R.V.R. Elettronica SpA
Via del Fonditore, 2/2c
40138 BOLOGNA ITALY
Tel. +39 051 6010506

3. First Aid

The personnel employed in the installation, use and maintenance of the device, shall be familiar with theory and practice of first aid.

3.1 Treatment of electrical shocks

3.1.1 If the victim is not responsive

Follow the A-B-C's of basic life support.

- Place victim flat on his back on a hard surface.
- Open airway: lift up neck, push forehead back (**Figure 1**).

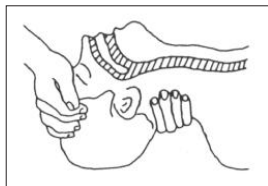

Figure 1

- clear out mouth if necessary and observe for breathing
- if not breathing, begin artificial breathing (**Figure 2**): tilt head, pinch nostrils, make airtight seal, four quick full breaths. Remember mouth to mouth resuscitation must be commenced as soon as possible.



Figure 2

- Check carotid pulse (**Figure 3**); if pulse is absent, begin artificial circulation (**Figure 4**) depressing sternum (**Figure 5**).

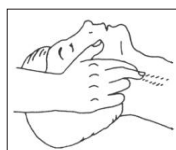

Figure 3



Figure 4

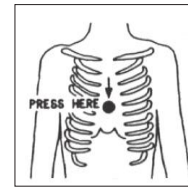

Figure 5

- In case of only one rescuer, 15 compressions alternated to two breaths.
- If there are two rescuers, the rhythm shall be of one breath each 5 compressions.
- Do not interrupt the rhythm of compressions when the second person is giving breath.
- Call for medical assistance as soon as possible.

3.1.2 If victim is responsive

- Keep them warm.
- Keep them as quiet as possible.
- Loosen their clothing (a reclining position is recommended).
- Call for medical help as soon as possible.

3.2 Treatment of electrical Burns

3.2.1 Extensive burned and broken skin

- Cover area with clean sheet or cloth.
- Do not break blisters, remove tissue, remove adhered particles of clothing, or apply any salve or ointment.
- Treat victim for shock as required.
- Arrange transportation to a hospital as quickly as possible.
- If arms or legs are affected keep them elevated.

If medical help will not be available within an hour and the victim is conscious and not vomiting, give him a weak solution of salt and soda: 1 level teaspoonful of salt and 1/2 level teaspoonful of baking soda to each quart of water (neither hot or cold).

Allow victim to sip slowly about 4 ounces (half a glass) over a period of 15 minutes.

Discontinue fluid if vomiting occurs.

DO NOT give alcohol.

3.2.2 Less severe burns

- Apply cool (not ice cold) compresses using the cleansed available cloth article.
- Do not break blisters, remove tissue, remove adhered particles of clothing, or apply salve or ointment.
- Apply clean dry dressing if necessary.
- Treat victim for shock as required.
- Arrange transportation to a hospital as quickly as possible.
- If arms or legs are affected keep them elevated.

4. General Description

PWRMETER-D1, manufactured by R.V.R. Elettronica SpA, is a power meter that can display both the forward that the reflected power with full-scale set by factory.

PWRMETER-D1, with a height of 3 units, have been designed for installation in a rack standard 19“.

4.1 Unpacking

The package contains:

- 1 **PWRMETER-D1**
- 1 User Manual
- 1 Mains power cable

The following accessories are also available from Your R.V.R. Dealer:

- **Accessories, spare parts and cables**



4.2 Features

An LCD on the front panel and a push-button board provide for user interfacing with the microprocessor control system, which offers the following features:

- Measurement and display of transmitter operating parameters.
- Communication with external devices such as programming via RS232 serial interface.



Four LEDs on the front panel provide the **ALARM** status indications on limits imposed on -1dB , -3dB, SWR and SWR1.

Telemetry connector on the back of **PWRMETER-D1** provides remote indication outputs through relay contacts.

The power meter management firmware is based on a menu system. User has four navigation buttons available to browse submenus: **ESC**, , , and **ENTER**.

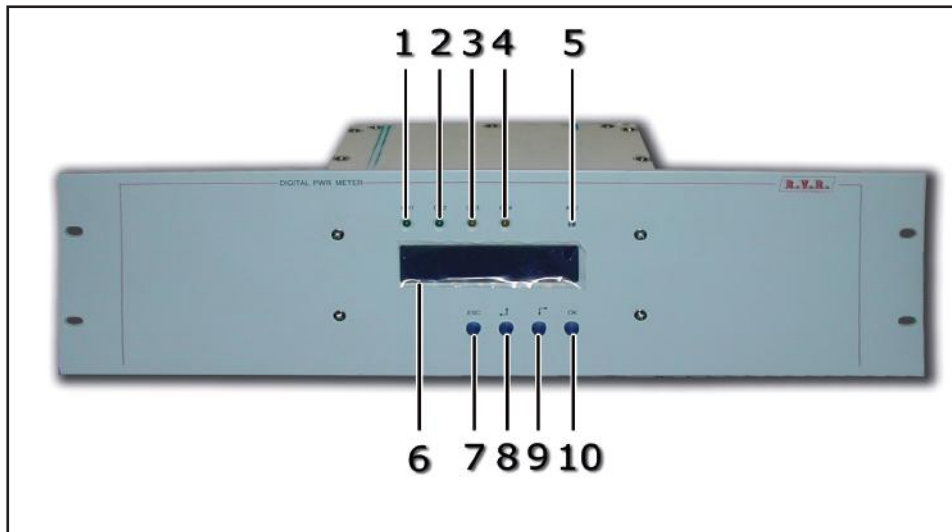
4.3 Frontal Panel Description



- | | |
|---|--|
| [1] CH1 LED | Green LED - lit on when the limit imposed on -1dB , adjustable via SET menu, is exceeded. |
| [2] CH2 LED | Green LED - lit on when the limit imposed on -3dB , adjustable via SET menu, is exceeded. |
| [3] CH3 LED | Yellow LED - lit on when the limit imposed on SWR , adjustable via SET menu, is exceeded. |
| [4] CH4 LED | Yellow LED - lit on when the limit imposed on SWR1 , adjustable via SET menu, is exceeded. |
| [6] DISPLAY | Liquid Crystal Display. |
| [7] ESC | Press this button to exit a menu. |
| [8]  | Navigation button used to browse menu system and edit parameters. |
| [9]  | Navigation button used to browse menu system and edit parameters. |
| [10] ENTER | Press this button to confirm a modified parameter and open a menu. |

4.4 Rear Panel Description

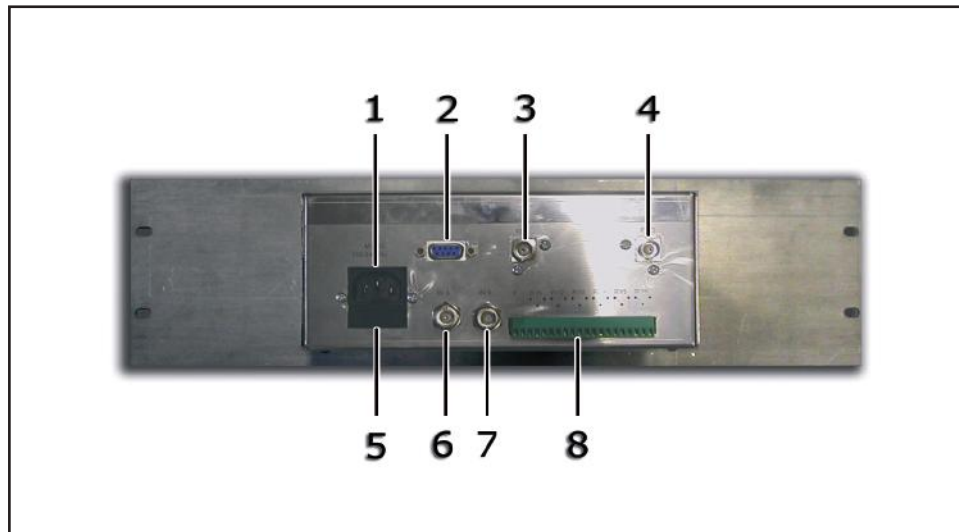

- | | |
|--|---|
| <p>[1] PLUG
 [2] RS232
 [3] RFL
 [4] FWD
 [5] FUSE BLOCK
 [6] IN3
 [7] IN4
 [8] TERMINAL BOARD</p> | <p>Mains supply plug.
 DB9 connector for configuration of equipment.
 RF input connector for reflected power, BNC type.
 RF input connector for forward power, BNC type.
 Fuse carrier. Use a screwdriver to access the fuse. Contains the general protection fuse.
 RF input connector for AUX-1, BNC type.
 RF input connector for AUX-2, BNC type.
 Three remote signalling relays output with isolated diverter contact (0.5A 48V max).
 Standards Setting:
 Relay 1 = 80% of forward power measurement
 Relay 2 = 50% of forward power measurement
 Relay 3 = 50% of reflected power measurement
 Relay 4 = 2:1 of Standing Wave Ratio measurement
 Relay 5 = 50% of AUX-1 power measurement
 Relay 6 = 50% of AUX-2 power measurement</p> |
|--|---|

4.5 Connectors Description

4.5.1 RS232

Type: Female DB9

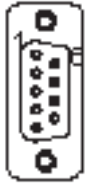

- | | |
|---|---------------------------------|
| 1 | N.C. |
| 2 | TXD |
| 3 | RXD |
| 4 | Internally connected to 7 and 8 |
| 5 | GND |
| 6 | N.C. |
| 7 | Internally connected to 4 and 8 |
| 8 | Internally connected to 4 and 7 |
| 9 | N.C. |

5. Quick guide for installation and use

This section provides a step-by-step description of equipment installation and configuration procedure. Follow these procedures closely upon first power-on and each time any change is made to general configuration, such as when a new transmission station is added or the equipment is replaced.

Once the desired configuration has been set up, no more settings are required for normal operation; at each power-up (even after an accidental shutdown), the equipment defaults to the parameters set during the initial configuration procedure.

The topics covered in this section are discussed at greater length in the next sections, with detailed descriptions of all hardware and firmware features and capabilities. Please see the relevant sections for additional details.



IMPORTANT: When configuring and testing the power meter in which the equipment is integrated, be sure to have the Final Test Table supplied with the equipment ready at hand throughout the whole procedure; the Final Test Table lists all operating parameters as set and tested at the factory.

5.1 Preparation

5.1.1 Preliminary checks

Unpack the **PWRMETER-D1** and immediately inspect it for transport damage. Ensure that all connectors are in perfect condition.

The main fuse can be accessed from the outside on the rear panel. Extract the fuse carrier with a screwdriver to check its integrity or for replacement, if necessary. The following fuses are used:

	Fuse
Mains	(2x) 1A T type 5x20

Table 5.1: Fuse

Provide for the following (applicable to operating tests and putting into service):

- √ Full-range mains power supply, 90÷240 VAC, with adequate earth connection.
- √ Connection cable kit including:
 - Mains power cable.
 - Cables between **PWRMETER-D1** and the source drawings of the forward and reflected power signals (with BNC connectors).

The **PWRMETER-D1** must be installed on a rack that includes an anti-strap device to prevent the possibility of accidental disconnection of feeding conductors.

5.1.2 Mains power supply



Warning: Disconnect mains power supply before beginning these procedure.

The power supply of the **PWRMETER-D1** is equipped with its own fuses: check all fuses to ensure they are properly rated for the power mains and change them as required to match mains voltage.

All mains power supply protection fuses are conveniently located on the rear panel and are easily accessed (see chap. 6): to check or replace a fuse, **disconnect equipment from power mains**, remove the fuse from the fuse carrier after removing the cover.

The main power supply unit is the full-range type and requires no voltage setup.

5.2 Operation

Power on the **PWRMETER-D1**. Equipment name should appear briefly on the display, quickly followed by forward and reflected power readings (Menu 1) and other measure, provided that the exciter is delivering output power.



NOTE: Take note that certain parameters, which are measured and shown to the user, might not be available in a few cases. This occurs when, for physical reasons, the measured values are not significant for control software internal use.

When the value of a parameter is not available for the aforesaid reason, symbol “==” appears on the display in lieu of the value.

Fwd Pwr	2.01	kW
Rf1 Pwr	20	W▼

Menu 1

Next, you can read all operating parameters of the equipment through the management firmware.

Normally, the equipment can run unattended. Any alarm condition is handled automatically by the safety system or is signalled by display messages and by relays of terminal board on rear panel.

5.3 Management Firmware

The equipment features an LCD with two lines by 16 characters that displays a set of menus. The figure below provides an overview of equipment menus.

The symbols listed below appear in the left portion of the display as appropriate:

- (Cursor) - Highlights selected (i.e. accessible) menu or parameter is being edited.
- ▲ (Up arrow) - Indicates that the menu can be scrolled upwards.
- ▼ (Down arrow) - Indicates that the menu can be scrolled downwards.

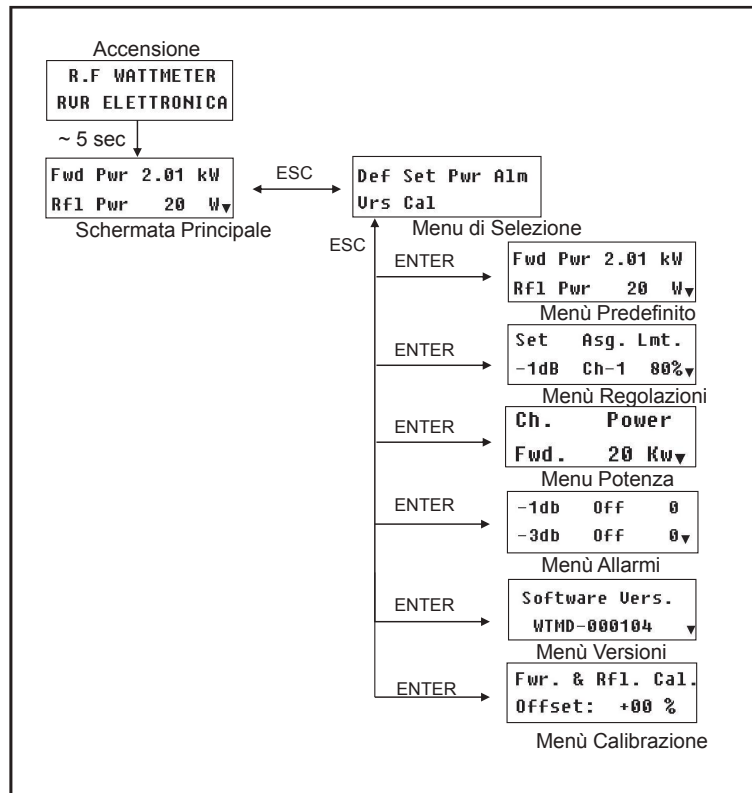



Figure 5.1

When the backlight is off, touching any key will turn on backlighting.

When the display is on, pressing the **ESC** key from the **Main menu** (menu 1) calls up the **selection screen**, which gives access to all other menus:



R.F WATTMETER
RUR ELETTRONICA

Menu 2



To gain access to a submenu, select menu name (name is highlighted by cursor) using key  or  and press the **ENTER** key.

To return to the Main menu, simply press **ESC** again.

5.4.1 Default menu (Pwr)

This multi-line scrollable menu, through  and  keys, allows the user to read all the measurements related to the behaviour of the power section of the station:

- Forward Power (Fwd Pwr)
- Reflected Power (Rfl Pwr)
- Input Power (AUX-1), voltage input IN3
- Input Power (AUX-2), voltage input IN4
- Standing Wave Ratio (SWR)

The complete aspect of the screen is the following figure (please note that only two lines at a time are visible, use the  and  keys to scroll):

Fwd Pwr	2.01	kW
Rfl Pwr	20	W
Aux-1	====	==
Aux-2	0	%
S.W.R.	=.	=

Menu 3





For the fine adjustment on display for forward (FWD) and reflected power (RFL) and the input voltage (IN3 or IN4) measured by the meter.



5.4.2 Threshold setting menu (Set)

The **PWRMETER-D1** offers a maximum of six user settable alarms. For each of them, one of the working parameters is compared against a threshold value that can be modified by the user. The results of the comparisons are available on the telemetry connector or as dry contacts on the optional external telemetry board.

Two of the settable thresholds are related to the RF emitted power (**Power Good**), while the third is connected to the amount of reflected power (**Reflected Warning**).

To change the values of the thresholds, execute the following procedure:

- Select the line to modify ( and  keys)
- Push the **ENTER** key
- Modify the value of the threshold ( and  keys)
- Push the **ENTER** key to confirm

The complete aspect of the screen is the following figure (please note that only two lines at a time are visible, use the  and  keys to scroll):

Set	Asg.	Lmt.
-1dB	Ch-1	80%
-3dB	Ch-1	50%
SWR	Ch-2	50%
SWR1	SWR	2.0
Pg5	Ch-3	50%
Pg6	Ch-4	50%

Menu 4



- **Set**

With this field you can identify and select the value on which you can act alarm adjusting, to be chosen from the following:

- 1) -1 db is related to RLY1
- 2) -3 db is related to RLY2
- 3) SWR is related to RLY3
- 4) SWR1 is related to RLY4
- 5) Pg5 is related to RLY5
- 6) Pg6 is related to RLY6





- **Assign (Asg.)**
With this field you can select the input to which you want to control, to be chosen from the following:
 - 1) CH1 is related to Forward Power input
 - 2) CH2 is related to Reflected Power input
 - 3) CH3 is related to AUX-1 input
 - 4) CH4 is related to AUX-2 input
 - 5) SWR is related to virtual input formed inside the **PWRMETER-D1**
- **Limit (Lmt.)**
With this field, you can select the limit in percentage beyond which it will be detected as an alarm, changed the status of the properly relay and reported the event in the alarm menu.



5.4.3 Power Menu (Pwr)

This multi-line scrollable menu, through  and  keys, allows the user to set the full-scale of all the measurements read by the meter related to the behaviour of the power section of the station:

- Forward Power (**Fwd.**) expressed in W or kW
- Reflected Power (**Rfl.**) expressed in W or kW
- Input Power (**AUX-1**), voltage input IN3 with power conversion measure expressed in W or kW
- Input Power (**AUX-2**), linear voltage input IN4 expressed in percentage

To change the values of the thresholds, execute the following procedure:



- Select the line to modify ( and  keys)
- Push the **ENTER** key
- Modify the value of the threshold ( and  keys)
- Push the **ENTER** key to confirm

The complete aspect of the screen is the following figure (please note that only two lines at a time are visible, use the  and  keys to scroll):

Ch.	Power
Fwd.	20 Kw
Rfl.	2 Kw
Aux-1	100 W
Aux-2	100



Menu 5

5.4.4 Alarms menu (Alm)

This multi-line scrollable menu, through  and  keys, gives to the user information regarding the status of the protection system included in the meter.

It is constituted by a certain number of lines, each containing the name of a variable controlled by the system and the count of times in case the parameter exceeded the limits imposed in **SET** menu.

The latter can be of the kind: **Name of parameter**, **Off** (Disabled) and **X** (Count).

The aspect of this multi-line screen is the following (only two lines at a time are visible, use the  and  keys to scroll):

-1db	Off	0
-3db	Off	0
SWR	Off	0
SWR1	Off	0
Pg5	Off	0
Pg6	Off	0
<Cr>	Reset	All

Menu 6

The function of this menu is essentially a help for the technician to identify the causes of possible malfunctions of the transmitter.

The last field (Reset All) allows you to reset all the logs recorded by pushing the **ENTER** key to confirm.

5.4.7 Version menu (Vrs)

This menu shows the hardware and software versions of the machine.

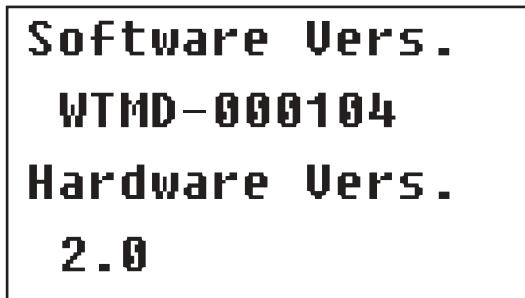

```
Software Vers.  
WTMD-000104  
Hardware Vers.  
2.0
```





Menu 7

5.4.8 Calibration menu (Cal)

This menu allows the user to adjust an offset on displayed power:

- Offset expressed in percentage, adjustable from -25% to +25%.

To change the values of the thresholds, execute the following procedure:

- Select the line to modify ( and  keys)
- Push the **ENTER** key
- Modify the value of the threshold ( and  keys)
- Push the **ENTER** key to confirm

The following figure shows an example of configuration for this menu.

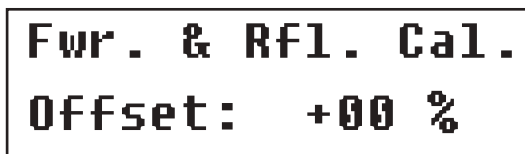

```
Fwr. & Rfl. Cal.  
Offset: +00 %
```

Menu 8

This menu is used to correct the reading of power to compensate for the difference of the directional coupling across the full bandwidth without re-adjustment of the instrument.

6. Identification and Access to the Modules

6.1 Identification of the Modules

The **PWRMETER-D1** is made up of several modules connected through connectors to facilitate maintenance and replacement (if needed).

The figure below shows the equipment upper view with the various components pointed out.

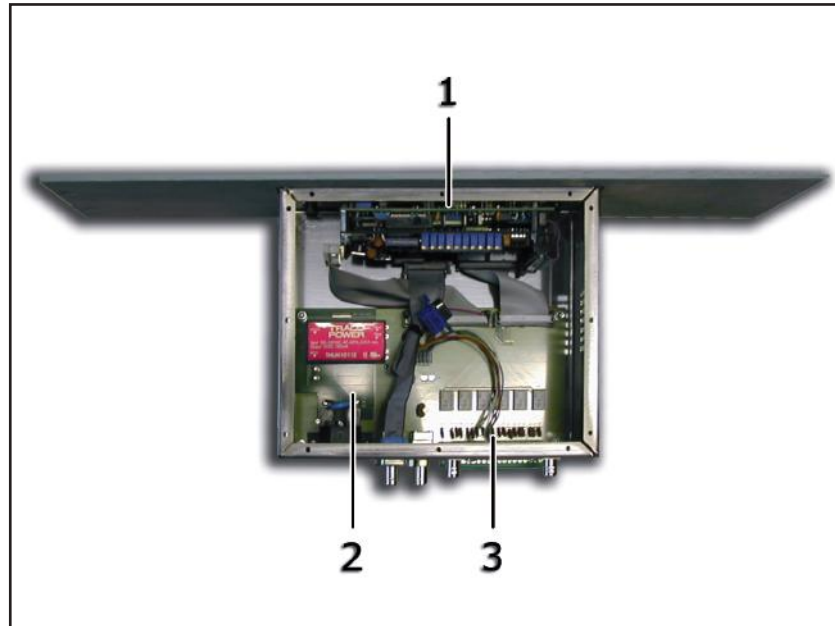

- [1] Power Meter Display card
- [2] Power meter interface card
- [3] RF RMS rectifier card

7. Working Principles

7.1 RF RMS rectifier card

RMS or PEAK rectifier card, depending on the assembly, which provides a proportional voltage referred to the power with quadratic law.

7.2 Power meter interface card

This card performs the following tasks:

- Switching power supply 90÷240VAC to 12V; it feeds the internal cards.
- A series of relays, controlled by power meter interface card, to give remote indication to outside.

By default the relays working, as describe in the following:

- Relay 1 = 80% of forward power measurement (-1dB),
- Relay 2 = 50% of forward power measurement (-3dB),
- Relay 3 = 50% of reflected power measurement (SWR).
- Relay 4 = 2.0 of Standing Wave Ratio measurement (SWR1),
- Relay 5 = 50% of AUX-1 power measurement (PG5),
- Relay 6 = 50% of AUX-2 power measurement (PG6).

7.3 Power Meter Display card

The panel board accommodates the microcontroller that runs equipment firmware and all user interface elements (display, LEDs, keys, ...).

This card is interfaced with other equipment modules via *flat cables* and provides for power supply, control signals and measurement distribution.

Using this card, you can make fine adjustments on the forward power (FWD Pwr), reflected power (RFL Pwr) and the input voltage (IN3 or IN4) measured by power meter, through the trimmer visible on top of **PWRMETER-D1**.

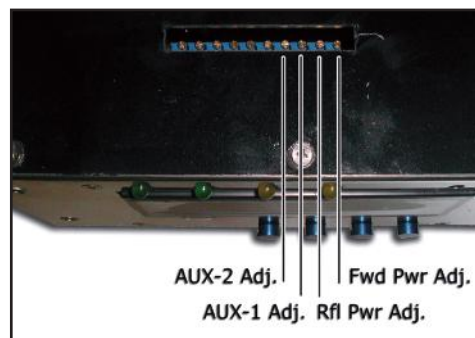

Figure 8.2



R.V.R. Elettronica S.p.A.

Via del Fonditore, 2 / 2c
Zona Industriale Roveri · 40138 Bologna · Italy
Phone: +39 051 6010506 · Fax: +39 051 6011104
e-mail: info@rvr.it · web: <http://www.rvr.it>

ISO 9001:2000 certified since 2000



The RVR Logo, and others referenced RVR products and services are trademarks of RVR Elettronica S.p.A. in Italy, other countries or both. RVR ® 1998 all rights reserved.
All other trademarks, trade names or logos used are property of their respective owners.