

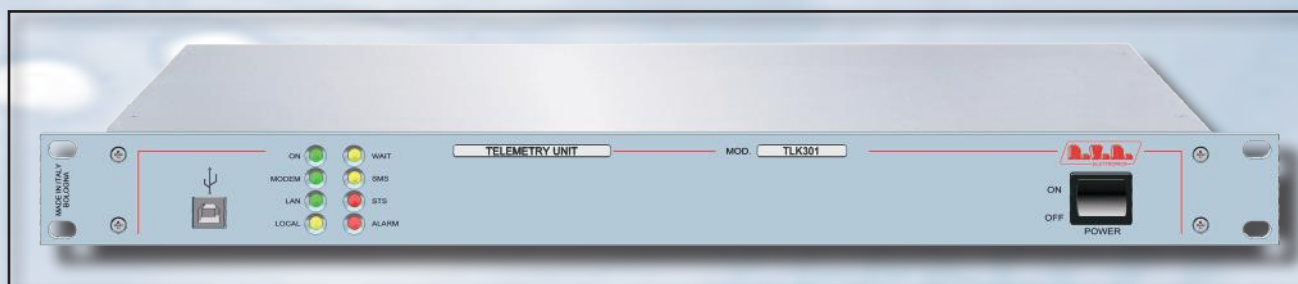

# TLK301 ( /N1, /N2, /N3 & /N4 )

USER MANUAL  
VOLUME1



**File Name:** TLK301\_V1-V2-V3-V4\_ING\_1.0.indb

**Version:** 1.0

**Date:** 10/07/2023

### Revision History

Date	Version	Reason	Editor
10/07/2023	1.0	First Version	J. H. Berti

TLK301 ( /V1, /V2 , /V3 & /V4 ) - User Manua  
Version 1.0

© Copyright 2023

R.V.R. Elettronica S.r.l.

Via del Fonditore 2/2c - 40138 - Bologna (Italia)

Telephone: +39 051 6010506

Fax: +39 051 6011104

Email: info@rvr.it

Web: www.rvr.it

All rights reserved

Printed and bound in Italy. No part of this manual may be reproduced, memorized or transmitted in any form or by any means, electronic or mechanic, including photocopying, recording or by any information storage and retrieval system, without written permission of the copyright owner.

#### **Notification of intended purpose and limitations of product use**

This product is a FM transmitter intended for FM audio broadcasting. It utilizes operating frequencies not harmonised in the intended countries of use. The user must obtain a license before using the product in intended country of use. Ensure respective country licensing requirements are complied with. Limitations of use can apply in respect of operating frequency, transmitter power and/or channel spacing.

#### **Declaration of Conformity**

Hereby, R.V.R. Elettronica, declares that this FM transmitter is in compliance with the essential requirements and other relevant provisions of Directive 2014/53/EU.



# Technical Specifications

		TLK301			
<i>Parameters</i>	<i>Conditions</i>	<i>U.M.</i>	<i>Value</i>	<i>Notes</i>	
<b>GENERALS</b>					
Ambient working temperature		°C	-10 to + 50	Whithout condensing	
<b>POWER REQUIREMENTS</b>					
AC Power Input	AC Supply Voltage	VAC	80 ÷ 260 (*)	(*) Full range (**) Internal switch	
	Active Power Consumption	W	25		
DC Power Input	Connector		VDE IEC Standard		
	DC Supply Voltage	VDC	12		
	DC Current	ADC	< 3	(*)max 25W (**) max 140W	
<b>FUSES</b>					
On Mains			1 External fuse F 1 A F - 5X20 mm		
<b>MECHANICAL DIMENSIONS</b>					
Physical Dimensions	Front panel width	mm	483 (19")	19" EIA rack	
	Front panel height	mm	44 1HE		
	Overall depth	mm	263		
	Chassis depth	mm	239		
Weigh		kg	about 4,3		
<b>INTERFACES</b>					
Signalling LEDs			Yes		
Display	40x2 Alphanumerical		No		
Push buttons	4 (UP, DOWN, ENTER, ESC)		No		
USB	TELECON Protocol		Yes		
RS232	TELECON Protocol		Yes		
RS 485	PLUG-IN protocol		Yes (only on WEB+GSM versions)		
I <sup>2</sup> C			Yes		
RJ45	LAN		Yes (only on WEB versions)		
SIM slot & ANTENNA			Yes (only on GSM versions)		
<b>VARIOUS</b>					
Cooling			Convection cooling		
Acoustic Noise		dBA	0		

# Table of Contents

<b>1.</b>	<b>Preliminary Instructions</b>	<b>1</b>
<b>2.</b>	<b>Warranty</b>	<b>1</b>
<b>3.</b>	<b>First Aid</b>	<b>2</b>
3.1	Treatment of electrical shocks	2
3.2	Treatment of electrical Burns	2
<b>4.</b>	<b>General Description</b>	<b>3</b>
4.1	Unpacking	3
4.2	Features	3
4.3	Frontal Panel Description	5
4.4	Rear Panel Description	6
4.5	Connectors Description	10
<b>5.</b>	<b>Quick guide for installation and use</b>	<b>13</b>
5.1	Preparation	13
<b>6.</b>	<b>Identification and Access to the Modules</b>	<b>16</b>
6.1	Identification of the Modules	16
<b>7.</b>	<b>Working Principles</b>	<b>20</b>
7.1	Panel card	20
7.2	Mainboard	20
7.3	16-bit CPU Card	20
7.4	USB Card	20
7.5	LAN Card	21
7.6	Alarm generation	21
<b>8.</b>	<b>Web User Interface (WUI)</b>	<b>23</b>
8.1	Management Software	23
<b>9.</b>	<b>Versions with GSM</b>	<b>48</b>
<b>10.</b>	<b>Configurations of Transmitter System</b>	<b>50</b>
10.1	Configuration of Transmitter from V1 to V4 Versions	50
<b>11.</b>	<b>SNMP Telemetry</b>	<b>80</b>
11.1	MAIN MIB Description	80
11.1	SPECIFIC MIB Description	81
<b>12.</b>	<b>Connecting TLK to Internet network</b>	<b>87</b>

## IMPORTANT



The symbol of lightning inside a triangle placed on the product, evidences the operations for which is necessary gave it full attention to avoid risk of electric shocks.



The symbol of exclamation mark inside a triangle placed on the product, informs the user about the presence of instructions inside the manual that accompanies the equipment, important for the efficacy and the maintenance (repairs).

## 1. Preliminary Instructions

### • General Warnings

This equipment should only be operated, installed and maintained by "trained" or "qualified" personnel who are familiar with risks involved in working on electric and electronic circuits. "Trained" means personnel who have technical knowledge of equipment operation and who are responsible for their own safety and that of other unqualified personnel placed under their supervision when working on the equipment.

"Qualified" means personnel who are trained in and experienced with equipment operation and who are responsible for their own safety and that of other unqualified personnel placed under their supervision when working on the equipment.

 **WARNING: Residual voltage may be present inside the equipment even when the ON/OFF switch is set to Off. Before servicing the equipment, disconnect the power cord or switch off the main power panel and make sure the safety earth connection is connected. Some service situations may require inspecting the equipment with live circuits. Only trained and qualified personnel may work on the equipment live and shall be assisted by a trained person who shall keep ready to disconnect power supply at need.**

R.V.R. Elettronica shall not be liable for injury to persons or damage to property resulting from improper use or operation by trained/untrained and qualified/unqualified persons.

 **WARNING: The equipment is not water resistant. Any water entering the enclosure might impair proper operation. To prevent the risk of electrical shock or fire, do not expose this equipment to rain, dripping or moisture.**

Please observe local codes and fire prevention rules when installing and operating this equipment.

 **WARNING: This equipment contains exposed live parts involving an electrical shock hazard. Always disconnect power supply before removing any covers or other parts of the equipment.**

Ventilation slits and holes are provided to ensure reliable operation and prevent overheating; do not obstruct or cover these slits. Do not obstruct the ventilation slits under any circumstances. The product must not be incorporated in a rack unless adequate ventilation is provided or the manufacturer's instructions are followed closely.

 **WARNING: This equipment can radiate radiofrequency energy and, if not installed in compliance with manual instructions and applicable regulations, may cause interference with radio communications.**

 **WARNING: This equipment is fitted with earth connections both in the power cord and for the chassis. Make sure both are properly connected.**

Operation of this equipment in a residential area may cause radio interference, in which case the user may be required to take adequate measures.

The specifications and data contained herein are provided for information only and are subject to changes without prior notice. **R.V.R. Elettronica** disclaims all warranties, express or implied. While R.V.R. Elettronica attempts to provide accurate information, it cannot accept responsibility or liability for any errors or inaccuracies in this manual, including the products and the software described herein. **R.V.R. Elettronica** reserves the right to make changes to equipment design and/or specifications and to this manual at any time without prior notice.

### • Notice concerning product intended purpose and use limitations.

This product is a radio transmitter suitable for frequency-modulation audio radio broadcasting. Its operating frequencies are not harmonised in designated user countries. Before operating this equipment, user must obtain a licence to use radio spectrum from the competent authority in the designated user country. Operating frequency, transmitter power and other characteristics of the transmission system are subject to restrictions as specified in the licence.

## 2. Warranty

La **R.V.R. Elettronica** warrants this product to be free from defects in workmanship and its proper operation subject to the limitations set forth in the supplied Terms and Conditions. Please read the Terms and Conditions carefully, as purchase of the product or acceptance of the order acknowledgement imply acceptance of the Terms and Conditions. For the latest updated terms and conditions, please visit our web site at [WWW.RVR.IT](http://WWW.RVR.IT). The web site may be modified, removed or updated for any reason whatsoever without prior notice. The warranty will become null and void in the event the product enclosure is opened, the product is physically damaged, is repaired by unauthorised persons or is used for purposes other than its intended use, as well as in the event of improper use, unauthorised changes or neglect. In the event a defect is found, follow this procedure:

- 1 Contact the seller or distributor who sold the equipment; provide a description of the problem or malfunction for the event a quick fix is available.

Sellers and Distributors can provide the necessary information to troubleshoot the most frequently encountered problems. Normally, Sellers and Distributors can offer a faster repair service than the Manufacturer would. Please note that Sellers can pinpoint problems due to wrong installation.

- 2 If your Seller cannot help you, contact **R.V.R. Elettronica**. and describe the problem; if our staff deems it appropriate, you will receive an authorisation to return the equipment along with suitable instructions;
- 3 When you have received the authorisation, you may return the unit. Pack the unit carefully before shipment; use the original packaging whenever possible and seal the package perfectly. The customer bears all risks of loss (i.e., R.V.R. shall not be liable for loss or damage) until the package reaches the R.V.R. factory. For this reason, we recommend insuring the goods for their full value. Returns must be sent on a C.I.F. basis (PREPAID) to the address stated on the authorisation as specified by the R.V.R. Service Manager.



Units returned without a return authorisation may be rejected and sent back to the sender.

- Be sure to include a detailed report mentioning all problems you have found and copy of your original invoice (to show when the warranty period began) with the shipment.

Please send spare and warranty replacement parts orders to the address provided below. Make sure to specify equipment model and serial number, as well as part description and quantity.



R.V.R. Elettronica  
Via del Fonditore, 2/2c  
40138 BOLOGNA ITALY  
Tel. +39 051 6010506

## 3. First Aid

All personnel engaged in equipment installation, operation and maintenance must be familiar with first aid procedures and routines.

### 3.1 Electric shock treatment

#### 3.1.1 If the victim is unconscious

Follow the first aid procedures outlined below.

- Lay the victim down on his/her back on a firm surface.
- the neck and tilt the head backwards to free the airway system (**Figure 1**).

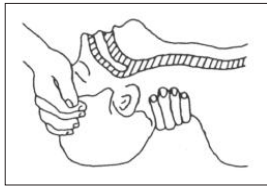

Figure 1

- If needed, open the victim's mouth and check for breathing.
- If there is no breathing, start artificial respiration without delay (**Figure 2**) as follows: tilt the head backwards, pinch the nostrils, seal your mouth around the victim's mouth and give four fast rescue breaths.



Figure 2

- Check for heartbeat (**Figure 3**); if there is no heartbeat, begin chest compressions immediately (**Figure 4**) placing your hands in the centre of the victim's chest (**Figure 5**).

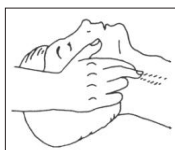

Figure 3



Figure 4

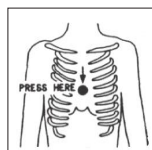

Figure 5

- One rescuer: give 2 quick rescue breaths after each 15 compressions.
- Two rescuers: one rescue breath after each 5 compressions.

- Do not stop chest compressions while giving artificial breathing.
- Call for medical help as soon as possible.

#### 3.1.2 If the victim is conscious

- Cover victim with a blanket.
- Try to reassure the victim.
- Loosen the victim's clothing and have him/her lie down.
- Call for medical help as soon as possible.

### 3.2 Treatment of electric burns

#### 3.2.1 Large burns and broken skin

- Cover affected area with a clean cloth or linen.
- Do not break any blisters that have formed; remove any clothing or fabric that is stuck to the skin; apply adequate ointment.
- Administer adequate treatment for the type of accident.
- Get the victim to a hospital as quickly as possible.
- Elevate arms and legs if injured.

If medical help is not available within an hour, the victim is conscious and is not retching, administer a solution of table salt and baking soda (one teaspoon of table salt to half teaspoon of baking soda every 250 ml of water).

Have the victim slowly drink half a glass of solution for four times during a period of 15 minutes.

Stop at the first sign of retching.

Do not administer alcoholic beverages.

#### 3.2.2 Minor burns

- Apply cold (not ice cold) strips of gauze or dress wound with clean cloth.
- Do not break any blisters that have formed; remove any clothing or fabric that is stuck to the skin; apply adequate ointment.
- If needed, have the victim change into clean, dry clothing.
- Administer adequate treatment for the type of accident.
- Get the victim to a hospital as quickly as possible.
- Elevate arms and legs if injured.

## 4. General Description

The **TLK301**, manufactured by R.V.R. Elettronica, is a telemetry system that allows a remote analysis of the radio transmitter in case of anomaly. Equipment great flexibility makes it possible to control a high number of devices or to modify the station layout. This operation does not involve any radical changes of the control system, it is simply a matter of adding expansion boards that will increase the number of operating parameters the system can manage.

**TLK301** is designed to being contained into a 19" rack box of 1HE.

### 4.1 Unpacking

The package contains:

- 1 **TLK301**
- 1 User Manual
- 1 Mains power cables

The following accessories are also available from Your R.V.R. Dealer:

- **Accessories, spare parts and cables**

### 4.2 Features

The **TLK301** telemetry device manage and control the alarms, send/receive text messages (SMS), connect to external/internal GSM and PSTN modems, WEB interfaces, send EMAIL and use the telecon control software designed by RVR. The various function depend on product versions.

The **TLK301** implements a connector for connections with the **SCMLCD4+1**; it also implements the protocols for SNMPv2 and SMTP Auth mail.

On the front panel there is also a set of LEDs, again depending on the preset configuration, which show system status at a glance.

On rear panel are present all connectors to be used for connections to various components of the station.

The **TLK301** telemetry system and relative management software were designed to solve all of those problems arising from the management of radio stations composed of several RVR devices, whether single or double exciter, being fully backward compatible with all versions with LCD display.

The versions from **/V1** up to **/V4** are specialized in the telemetry of systems including modular machines.

The system has the following main functions (the functions depends on version used) :

- Management of alarms;
- Storage of events that caused faults;
- Telemetrization of operating parameters of device present in each station;
- Use of TELECON management software developed by RVR;
- Connecting to modem External / Internal GSM and PSTN;
- Sending and receiving of SMS;
- WEB interfaces;
- Sending of MAIL;
- SNMP Agent.

This system allows remote management of the radio station, allowing the operator to intervene immediately in the event of a fault.

On the rear panel are all of the connectors to be used for connecting the device to the various station components.

The TELECON management software is easy to understand, as well as the WEB interface used for remote management of the device it is fully compatible with all browsers.

The **TLK301** telemetry system comes in different configurations summarized below:

- Version **V1**: serial telemetry unit for transmitter of Compact and Modular family.
- Version **V2**: GSM telemetry unit for transmitter of Compact and Modular family.
- Version **V3**: WEB telemetry unit for transmitter of Compact and Modular family.
- Version **V4**: GSM e WEB telemetry unit for transmitter of Compact and Modular family.



## 4.3 Frontal Panel Description

### 4.3.1 Frontal Panel Description of TLK301

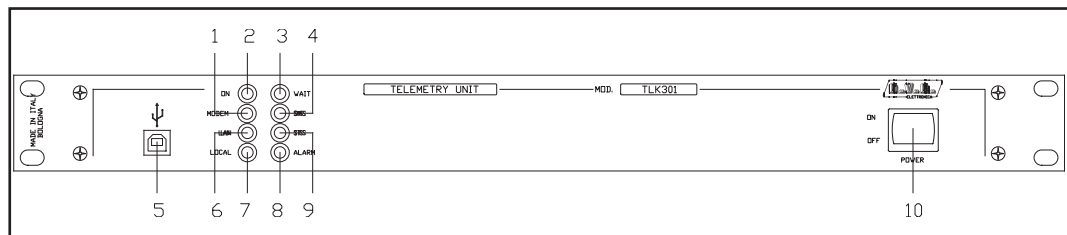

- |            |   |
|------------|---|
| [1] MODEM  | Green LED, turns on when modem is connected and it is properly initialized.   |
| [2] ON     | Green LED, turns on when the equipment is connected to mains power supply.  |
| [3] WAIT   | Yellow LED, when flashing indicates the Start up of equipment. When on, indicates that Start time is active. No alarm messages will be sent until this LED turns off. |
| [4] SMS    | Yellow LED, indicates that it is transmitting an alarm signal by SMS.   |
| [5] USB    | USB Type B connector for programming of firmware and local interfacing with TELECON software.   |
| [6] LAN    | The USB connection automatically puts the unit in local mode. Green LED, turns on when the LAN option is present and properly communicating.                          |
| [7] LOCAL  | Yellow LED, turns on when the equipment is in local operating status.   |
| [8] ALARM  | Red LED, turns on when an alarm is present in the alarm list.   |
| [9] STS    | Red LED, turns on when one of alarm condition is present.   |
| [10] POWER | ON/OFF switch.  |

## 4.4 Rear Panel Description

### 4.4.1 Rear Panel Description of TLK301 /V1

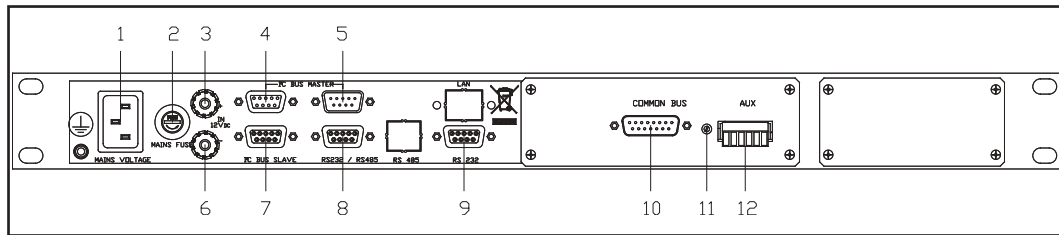

- |                      |   |
|----------------------|---|
| [1] PLUG             | VDE mains power supply connector.   |
| [2] MAINS FUSE       | Fuse carrier. Use a screwdriver to access the fuse.   |
| [3] 12 VDC IN +      | External 12Vdc supply input. Positive (red).  |
| [4] I²C BUS (MASTER) | DB9 female connector, for I²C sampling.<br>Lets you take control of external devices via bus.                                   |
| [5] I²C BUS (MASTER) | DB9 male connector, for I²C sampling.<br>Lets you take control of external devices via bus.                                     |
| [6] 12 VDC IN -      | External 12Vdc supply input. Negative (black).  |
| [7] I²C BUS SLAVE    | DB9 female connector, for I²C sampling.<br>Lets you to be controlled by external devices via bus.                               |
| [8] RS232 / 485      | DB9 female connector for serial sampling.   |
| [9] RS232            | DB9 connector for direct serial communication with the TELECON program and software update in exchange with frontal USB socket. |
| [10] COMMON BUS      | DB15 male connector for interfacing with other devices.   |
| [11] TRIMMER         | Lower power voltage adjustment trimmer.   |
| [12] AUX             | Auxiliary connector   |

## 4.4.2 Rear Panel Description of TLK301 /V2

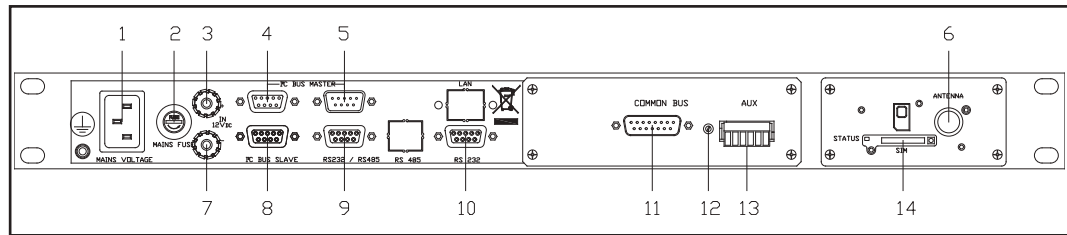

- |                                   |   |
|-----------------------------------|---|
| [1] PLUG                          | VDE mains power supply connector.   |
| [2] MAINS FUSE                    | Fuse carrier. Use a screwdriver to access the fuse.   |
| [3] 12 VDC IN +                   | External 12Vdc supply input. Positive (red).  |
| [4] I <sup>2</sup> C BUS (MASTER) | DB9 female connector, for I <sup>2</sup> C sampling.<br>Lets you take control of external devices via bus.                      |
| [5] I <sup>2</sup> C BUS (MASTER) | DB9 male connector, for I <sup>2</sup> C sampling.<br>Lets you take control of external devices via bus.                        |
| [6] ANTENNA                       | SMA female connector for connection to a GSM antenna.   |
| [7] 12 VDC IN -                   | External 12Vdc supply input. Negative (black).  |
| [8] I <sup>2</sup> C BUS SLAVE    | DB9 female connector, for I <sup>2</sup> C sampling.<br>Lets you to be controlled by external devices via bus.                  |
| [9] RS232 / 485                   | DB9 female connector for serial sampling.   |
| [10] RS232                        | DB9 connector for direct serial communication with the TELECON program and software update in exchange with frontal USB socket. |
| [11] COMMON BUS                   | DB15 male connector for interfacing with other devices.   |
| [12] TRIMMER                      | Lower power voltage adjustment trimmer.   |
| [13] AUX                          | Auxiliary connector.  |
| [14] SIM                          | SIM card tray.<br>On the left side there is a status LED.<br>On the right side there is the eject button for SIM card tray.     |

## 4.4.3 Rear Panel Description of TLK301 /V3

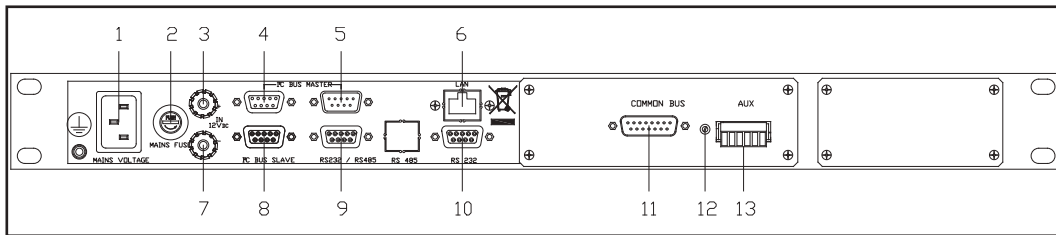

- |                                   |   |
|-----------------------------------|---|
| [1] PLUG                          | VDE mains power supply connector.   |
| [2] MAINS FUSE                    | Fuse carrier. Use a screwdriver to access the fuse.   |
| [3] 12 VDC IN +                   | External 12Vdc supply input. Positive (red).  |
| [4] I <sup>2</sup> C BUS (MASTER) | DB9 female connector, for I <sup>2</sup> C sampling.<br>Lets you take control of external devices via bus.                      |
| [5] I <sup>2</sup> C BUS (MASTER) | DB9 male connector, for I <sup>2</sup> C sampling.<br>Lets you take control of external devices via bus.                        |
| [6] ANTENNA                       | SMA female connector for connection to a GSM antenna.   |
| [7] 12 VDC IN -                   | External 12Vdc supply input. Negative (black).  |
| [8] I <sup>2</sup> C BUS SLAVE    | DB9 female connector, for I <sup>2</sup> C sampling.<br>Lets you to be controlled by external devices via bus.                  |
| [9] RS232 / 485                   | DB9 female connector for serial sampling.   |
| [10] RS232                        | DB9 connector for direct serial communication with the TELECON program and software update in exchange with frontal USB socket. |
| [11] COMMON BUS                   | DB15 male connector for interfacing with other devices.   |
| [12] TRIMMER                      | Lower power voltage adjustment trimmer.   |
| [13] AUX                          | Auxiliary connector.  |

## 4.4.4 Rear Panel Description of TLK301 /V4

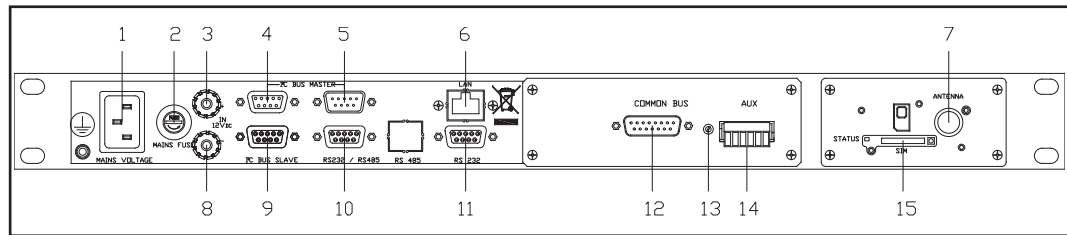

- |  |   |
|--|---|
| <p>[1] PLUG<br/>         [2] MAINS FUSE<br/>         [3] 12 VDC IN +<br/>         [4] I<sup>2</sup>C BUS (MASTER)<br/> <br/>         [5] I<sup>2</sup>C BUS (MASTER)<br/> <br/>         [6] LAN<br/>         [7] ANTENNA<br/>         [8] 12 VDC IN -<br/>         [9] I<sup>2</sup>C BUS SLAVE<br/> <br/>         [10] RS232 / 485<br/>         [11] RS232<br/> <br/>         [12] COMMON BUS<br/>         [13] TRIMMER<br/>         [14] AUX<br/>         [15] SIM</p> | <p>VDE mains power supply connector.<br/>         Fuse carrier. Use a screwdriver to access the fuse.<br/>         External 12Vdc supply input. Positive (red).<br/>         DB9 female connector, for I<sup>2</sup>C sampling.<br/>         Lets you take control of external devices via bus.<br/>         DB9 male connector, for I<sup>2</sup>C sampling.<br/>         Lets you take control of external devices via bus.<br/>         Connettore RJ45 per comunicazioni TCP/IP.<br/>         SMA female connector for connection to a GSM antenna.<br/>         External 12Vdc supply input. Negative (black).<br/>         DB9 female connector, for I<sup>2</sup>C sampling.<br/>         Lets you to be controlled by external devices via bus.<br/>         DB9 female connector for serial sampling.<br/>         DB9 connector for direct serial communication with the TELECON program and software update in exchange with frontal USB socket.<br/>         DB15 male connector for interfacing with other devices.<br/>         Lower power voltage adjustment trimmer.<br/>         Auxiliary connector<br/>         SIM card tray.<br/>         On the left side there is a status LED.<br/>         On the right side there is the eject button for SIM card tray.</p> |
|--|---|

## 4.5 Connectors Description

### 4.5.1 USB

Type: Female B-Type

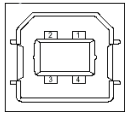

- 1 +V In
- 2 D-
- 3 D+
- 4 GND

### 4.5.2 LAN

Type: Female RJ45

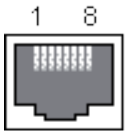

- 1 TX+
- 2 TX-
- 3 RX+
- 4 NC
- 5 NC
- 6 RX-
- 7 NC

### 4.5.3 RS232

Type: Male DB9

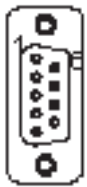

- 1 NC
- 2 SDA
- 3 SCL
- 4 NC
- 5 GND
- 6 NC
- 7 NC
- 8 NC
- 9 NC

### 4.5.4 I<sup>2</sup>C Bus

Type: Female DB9

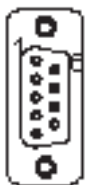

- 1 NC
- 2 SDA
- 3 SCL
- 4 NC
- 5 GND
- 6 NC
- 7 NC
- 8 NC
- 9 NC

## 4.5.5 I<sup>2</sup>C Bus

Type: Male DB9

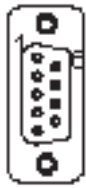

- 1 NC
- 2 SDA
- 3 SCL
- 4 NC
- 5 GND
- 6 NC
- 7 NC
- 8 NC
- 9 NC

## 4.5.6 RS485

Type: Female DB9



- 1 RS485 +
- 2 IC internally connected. Do not use.
- 3 GND
- 4 NC
- 5 IC internally connected. Do not use.
- 6 RS485 -
- 7 NC
- 8 NC
- 9 NC

## 4.5.7 I<sup>2</sup>C Bus Slave

Type: Female DB9

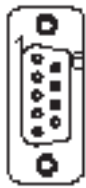

- 1 NC
- 2 SDA
- 3 SCL
- 4 NC
- 5 GND
- 6 NC
- 7 NC
- 8 NC
- 9 NC

## 4.5.8 AUX

Type: 6 PIN

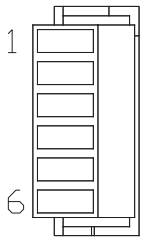

- 1 Normally Closed LOWER POWER
- 2 Common LOWER POWER
- 3 Normally Open LOWER POWER
- 4 Normally Closed INHIBIT PJ-C
- 5 Common INHIBIT PJ-C
- 6 Normally Open INHIBIT PJ-C

## 4.5.9 Common Bus

Type: Male DB15



- 1 GND
- 2 NC
- 3 NC
- 4 NC
- 5 PWR REG  
In case it is in Lower Power mode, then the trimmer regulated voltage comes out.  
If it is in Nominal Power mode, then no voltage (0V) comes out.
- 6 NC
- 7 NC
- 8 NC
- 9 NC
- 10 GND
- 11 NC
- 12 GND
- 13 GND
- 14 INHIBIT PJ-C  
If it is in ON mode, then it is normally closed towards GND (operation modifiable from J1 and J2 on COM-BUS board).  
If it is in OFF mode, then it is normally open (operation modifiable from J1 and J2 on COM-BUS board).



## 5. Quick guide for installation and use

This section provides a step-by-step description of equipment installation and configuration procedure. Follow these procedures closely upon first power-on and each time any change is made to general configuration, such as when a new transmission station is added or the equipment is replaced.

Once the desired configuration has been set up, no more settings are required for normal operation; at each power-up (even after an accidental shutdown), the equipment defaults to the parameters set during the initial configuration procedure.

The topics covered in this section are discussed at greater length in the next sections, with detailed descriptions of all hardware and firmware features and capabilities. Please see the relevant sections for additional details.



**IMPORTANT:** *When configuring and testing the transmitter in which the equipment is integrated, be sure to have the Final Test Table supplied with the equipment ready at hand throughout the whole procedure; the Final Test Table lists all operating parameters as set and tested at the factory.*

### 5.1 Preparation

#### 5.1.1 Preliminary checks

Unpack the transmitter and immediately inspect it for transport damage. Ensure that all connectors are in perfect condition.

The main fuse can be accessed from the outside on the rear panel. Extract the fuse carrier with a screwdriver to check its integrity or for replacement, if necessary. The fuse to be used is this type:

	@ 230 ±15% Vac
<b>TLK301</b> @ 230 Vac/115 Vac	(1x) 3.15A type 5x20

Table 5.1: Fuses

Provide for the following (applicable to operating tests and putting into service):

- √ Single-phase mains power supply, with adequate earth connection.
- √ Connection cable kit (**NOT INCLUDED**), including:
  - Cables for telemetry signals and sampling.
  - If a LAN output is present: Ethernet cable (with RJ45 connector) for connection to ADSL router or LAN.

## 5.1.2 Connections

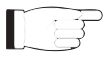

**Note:** the mains must be equipped with adequate earth connection properly connected to the equipment. This is a pre-requisite for ensuring operator safety and correct operation.

Connect the sampling cables of **TLK301** sources to output connectors of system to telemetric data, such as the **REMOTE** connector of transmitters.

If LAN output is present, connect the **ETHERNET** output of **TLK301** to the appropriate input of your ADSL router or LAN network. If the connecting device was different, identify an equivalent.

Connect the mains cable to the corresponding connector MAINS on **TLK301**.

## 5.1.3 Dip Switch configuration

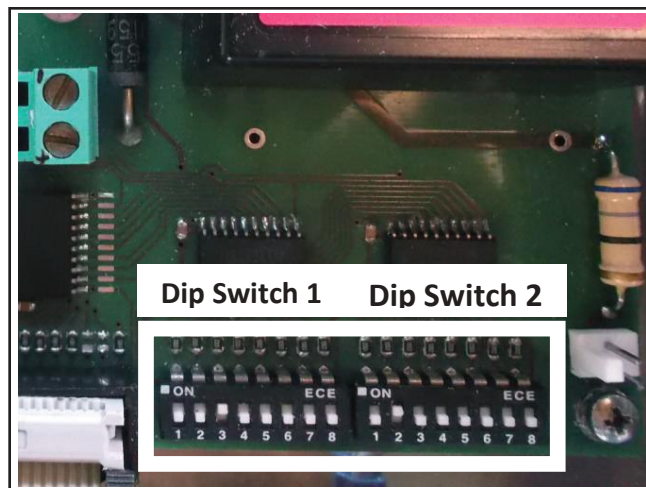

Photo 5.1: Dip Switch

	1	2	3	4	5	6	7	8	1	2	3	4	5	6	7	8
Modem None																
Modem PSTN Option	x															
Modem GSM Option		x														
Lan Option			x													
Not used				x												
Config TX									x	x	x	x	x			
Not used					x	x	x	x						x	x	x

Table 5.2: Dip Switch



**Note:** the modification of the settings in the Dip Switches must be done only and exclusively by trained and qualified personnel, aware of the risks connected to an incorrect application of the regulations. In case of doubts about the configuration to apply, please contact RVR ELETTRONICA Customer Service, describing the configuration and serial numbers of the machines to be used.

The first Dip Switch, from position 1 to position 2, is only available for the **TLK301/V2** and **TLK301/V4** versions and allows configuration in case of option with GSM modem.

Position 3 is only available for the **TLK301/V3** and **TLK301/V4** versions and allows configuration in case of option with LAN socket.

Position 4, available for all versions, allows configuration for the COM-BUS socket.



**Note:** *The position 4 of the first Dip Switch must be enabled only in presence of RVR amplifiers equipped with LD-MOS technology in their power supplies. Keep disabled in presence of RVR amplifiers without this technology.*

The position from 8 to 5 of the first Dip Switch must be set as binary numbering based on the I<sup>2</sup>C slave address to be assigned.

Dip Switch, from position 5 to position 1 (CONFIG TX), is to set as binary number based on the configuration number to which reference is made (for example the configuration 12 is equal to 00110, or the configuration 20 is equal to 00101).



**Note:** *for further information on the possible configurations, and on the correct setting of the Dip Switch, read the chapter on Configurations in this manual.*

### 5.1.3.1 Configuration of transmitter Version from V1 to V4

adr	TEX#1	TEX#2	SCM	HC o PA	PA	PA	PA	PA	PA
<b>Config 01</b>	1								
<b>Config 02</b>	1			4					
<b>Config 03</b>	1			4	5	6			
<b>Config 04</b>	1			4	5	6	7		
<b>Config 05</b>	1			4	5	6	7	8	
<b>Config 06</b>	1			4	5	6	7	8	9
<b>Config 07</b>	1	2	3	4					
<b>Config 08</b>	1	2	3	4	5	6			
<b>Config 09</b>	1	2	3	4	5	6	7		
<b>Config 10</b>	1	2	3	4	5	6	7	8	
<b>Config 11</b>	1	2	3	4	5	6	7	8	9
adr	PTX#1	PTX#2	SCM	HC o PA	PA	PA	PA	PA	PA
<b>Config 12</b>	1								
<b>Config 13</b>	1			4					
<b>Config 14</b>	1			4	5	6			
<b>Config 15</b>	1			4	5	6	7		
<b>Config 16</b>	1			4	5	6	7	8	
<b>Config 17</b>	1			4	5	6	7	8	9
<b>Config 18</b>	1	2	3	4					
<b>Config 19</b>	1	2	3	4	5	6			
<b>Config 20</b>	1	2	3	4	5	6	7		
<b>Config 21</b>	1	2	3	4	5	6	7	8	
<b>Config 22</b>	1	2	3	4	5	6	7	8	9

Table 5.3: TX configurations in versions from V1 to V4

## 6. Identification and Access to the Modules

### 6.1 Identification of the Modules

The **TLK301** are made up of various modules linked to each other through connectors so as to make maintenance and any required module replacement easier.

#### 6.1.1 TL301 versions /V1 - Upper view

The figure below shows the equipment upper view with the various components pointed out.

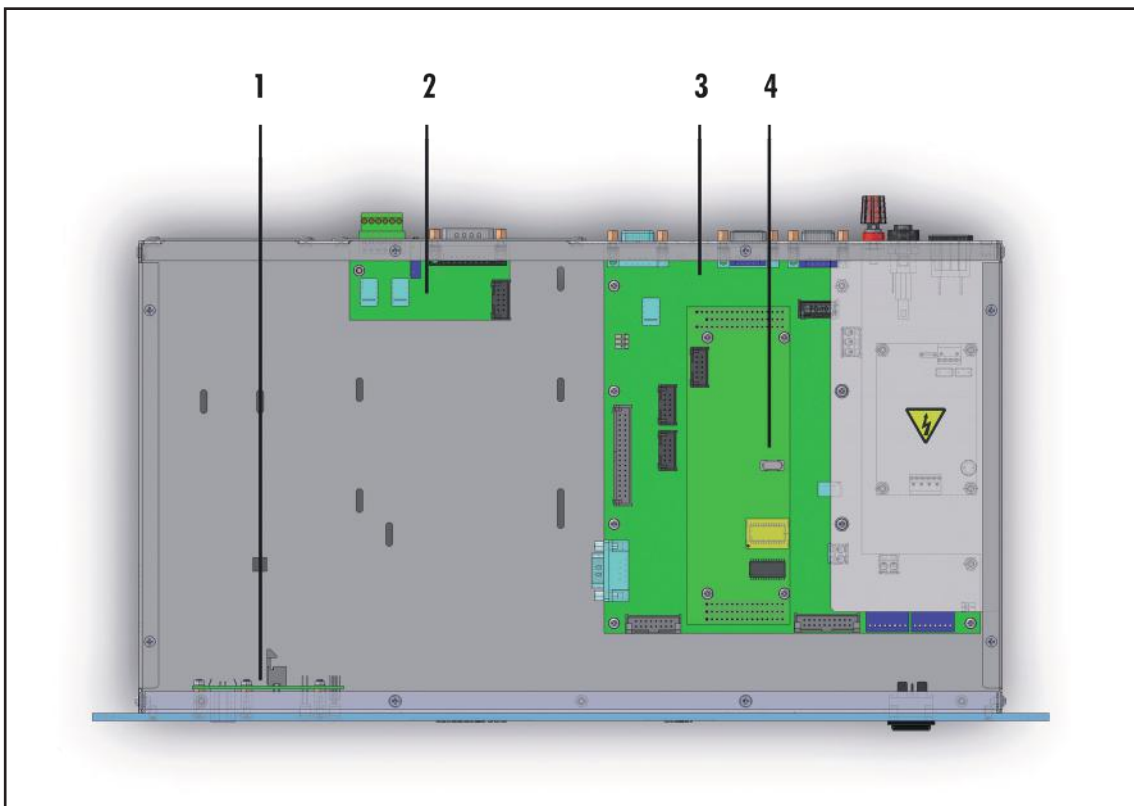

- [1] USB & LED card
- [2] COM-BUS interface card
- [3] Mainboard & Power Supply card
- [4] 16-bit CPU card

## 6.1.2 TL301 versions /V2 - Upper view

The figure below shows the equipment upper view with the various components pointed out.

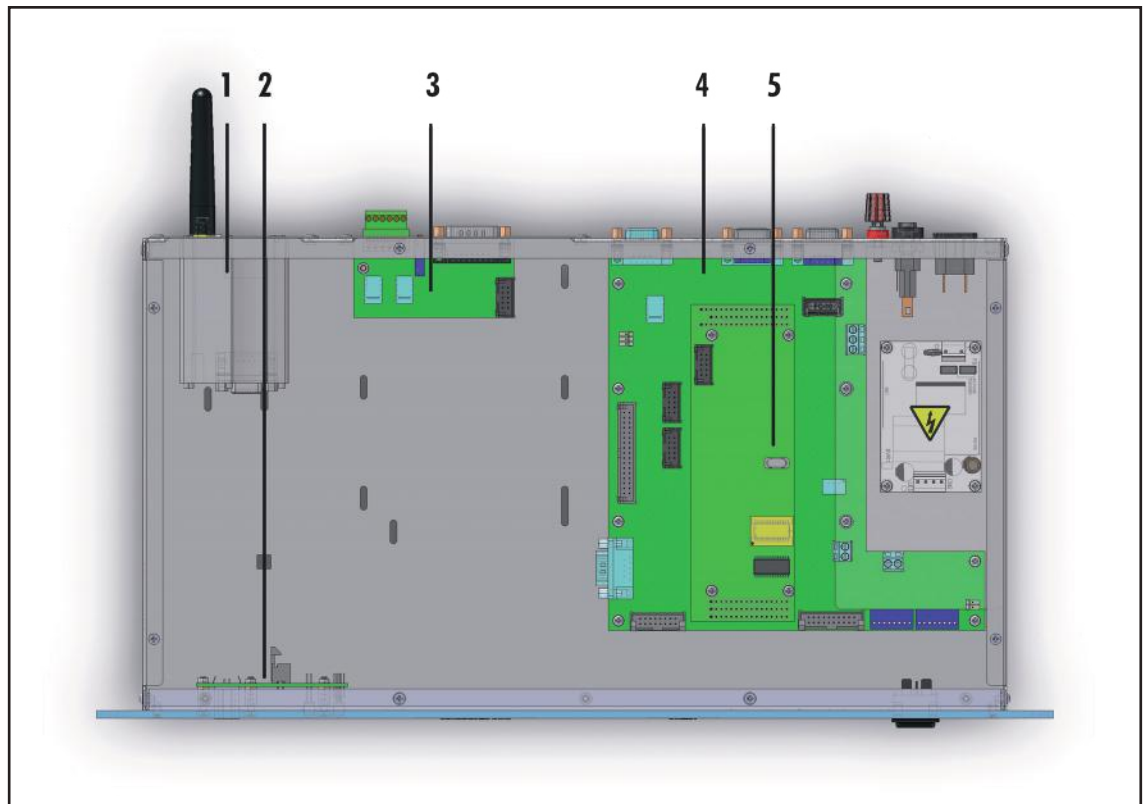

- [1] Modem GSM & Antenna
- [2] USB & LED card
- [4] COM-BUS interface card
- [5] Mainboard & Power Supply card
- [6] CPU 16-bit card

## 6.1.3 TL301 versions /V3 - Upper view

The figure below shows the equipment upper view with the various components pointed out.

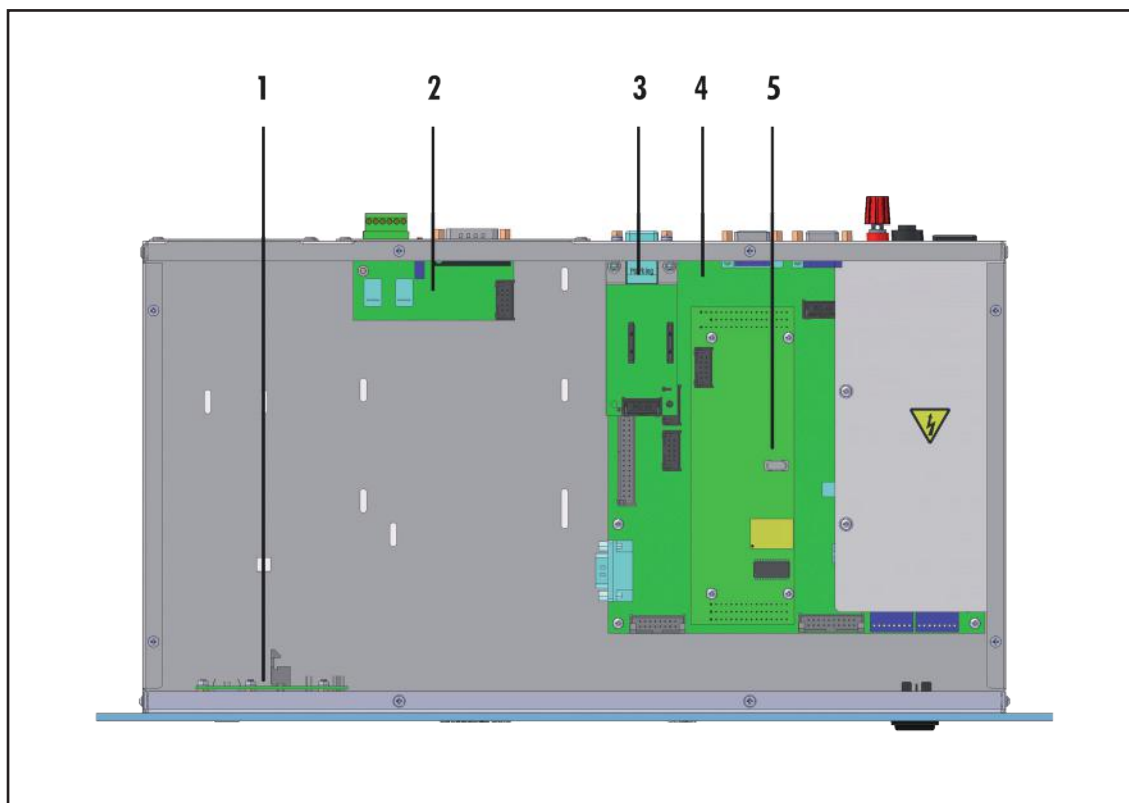

- [1] USB & LED card
- [2] COM-BUS interface card
- [3] LAN card
- [4] Mainboard & Power Supply card
- [5] 16-bit CPU card

## 6.1.4 TL301 versions /V4 - Upper view

The figure below shows the equipment upper view with the various components pointed out.

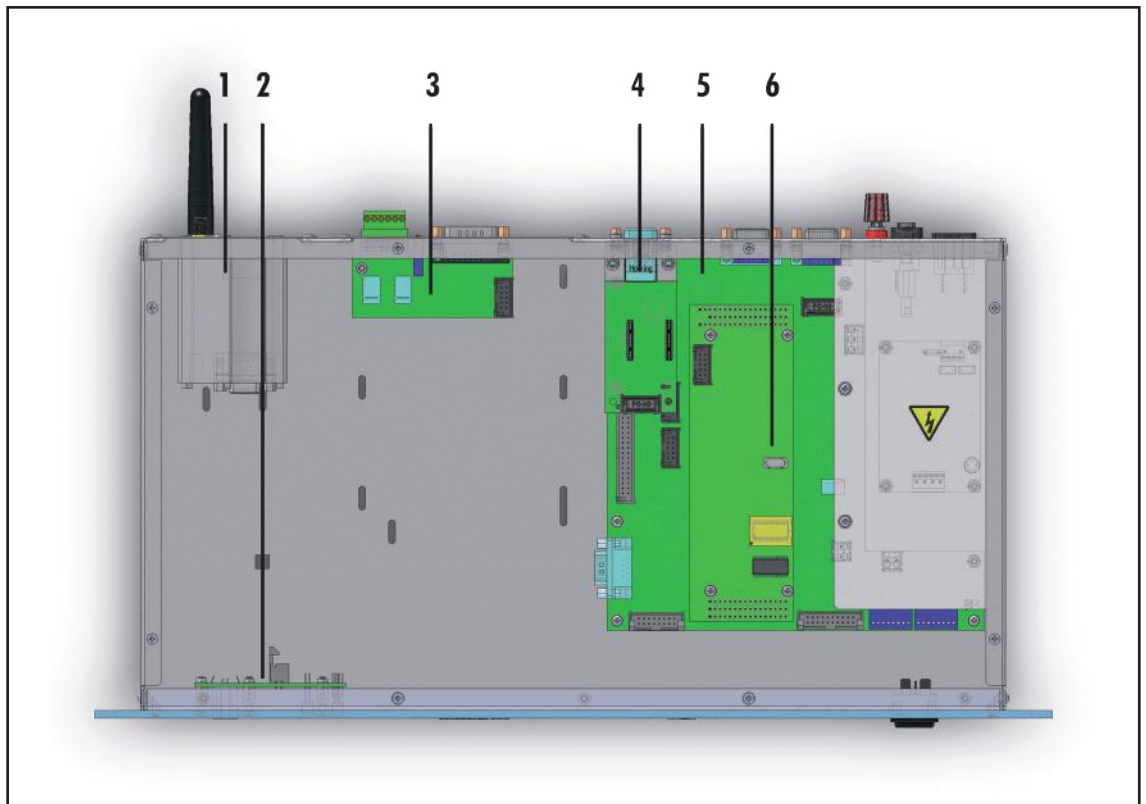

- [1] GSM Modem & Antenna
- [2] USB & LED card
- [3] COM-BUS interface card
- [4] LAN card
- [5] Mainboard & Power Supply card
- [6] 16-bit CPU card

## **7. Working Principles**

### **7.1 Panel card**

The panel card contains display and keys needed to interface with the user.

### **7.2 Mainboard**

The main board carries out the following functions:

- RS232, RS485, USB and I<sup>2</sup>C input/output treatment;
- Signal Processing Control;
- Management measures;
- Distribution of power supplies

The power supply is a “direct from mains” type and it can be connected to any voltage between 90 and 260 V without any adjustments or manual settings.

### **7.3 16-bit CPU Card**

The CPU card is located on the mainboard.

This card is the heart of the equipment as it handles and processes all information provided by the other cards and by other devices connected through the serial interface.

It is possible to perform firmware updates by directly connecting the RS232 output of **TLK301** to serial or USB port of one PC.

The card has a diagnostic LEDs to verify it works.

### **7.4 USB card**

This card adds an USB 2.0 port to allow connection to one PC by creating a virtual serial port.

The USB connector is used to program the firmware and to interface in local with TELECON software.

The USB connection automatically puts the equipment in local mode.



## 7.5 LAN card

This card adds a LAN port that allows you to connect itself to an equipment via TCP/IP. The visualization and modification of working parameters concern transmitter is so possible using an Internet browser in added Java and Ajax features.

## 7.6 Alarm generation

Alarm generation parameters are listed below:

- Output power supplied by transmitter (forward power good “PgD”);
- Reflected power supplied by transmitter (reflected power good “PgR”);
- Temperature status by trasnmitter (OVER TEMPERATURE);
- Presence of audio signal from both exciters;
- Mains voltage state (present or missing).

An inhibit time (start time) after power-on is provided to ensure false alarm prevention. When this inhibit time times out, the thresholds of alarm generation parameters are checked and remote alarms are sent if needed.

Alarm generation technique is outlined in the figure below; remote alarm delay, i.e. the amount of time the system waits before issuing a remote alarm after an alarm condition occurs is indicated in figure 7.1. When appropriate, a new line is added to the alarm log stored, up to twenty lines maximum.

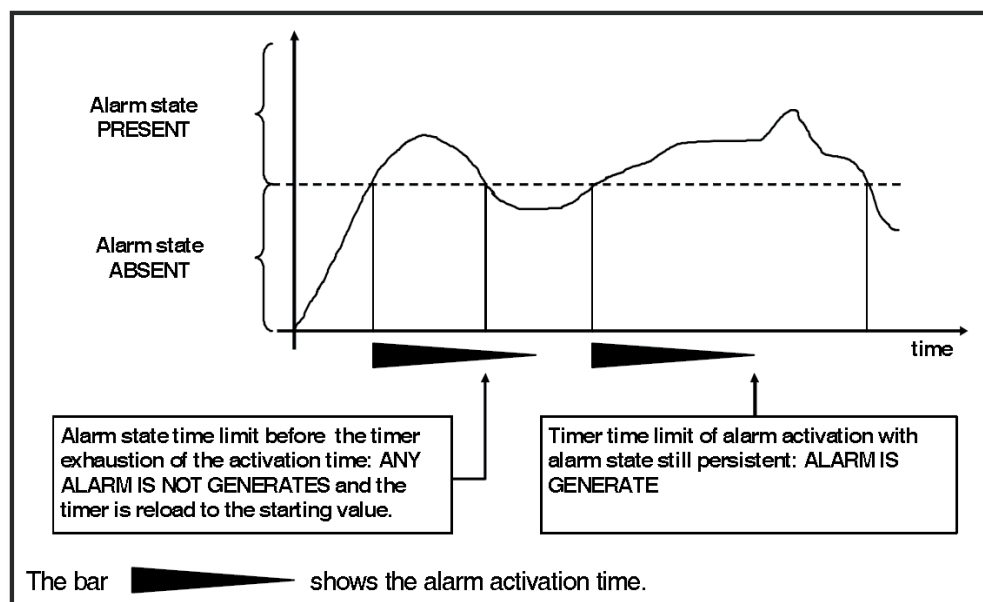

Figure 7.1

The alarm log may be reviewed using the “TELECON” software, or through SMS (see relevant section) only for GSM model when connected to an external modem, or through Trap viewable in a MIB browser only for WEB version with SNMP.



**WARNING:** The mains alarm is internally generated if the device is powered through appropriate terminals with an external 12V<sub>DC</sub>; instead, an SMS message indicating a normal condition is sent upon next start-up.

## 8. Web User Interface (WUI)

Once all connections previously described are performed, the equipment is ready for commissioning.

The **WUI** (Web User Interface) allows you to adjust, modify or display the configuration variables such as IP, netmask and gateway address. Follow the procedure below to open the **WUI**:

- 1) Open your web browser on your PC, and connect to ***http://192.168.0.244*** address to connect to the **WUI** (if LAN IP address was previously modified, it is necessary to use the new one). At this point the following page opens.

By factory the RVR uses the following adjustments:

- IP address: **192.168.0.244**
- Netmask address: **255.255.255.0**
- Gateway address: **192.168.0.1**

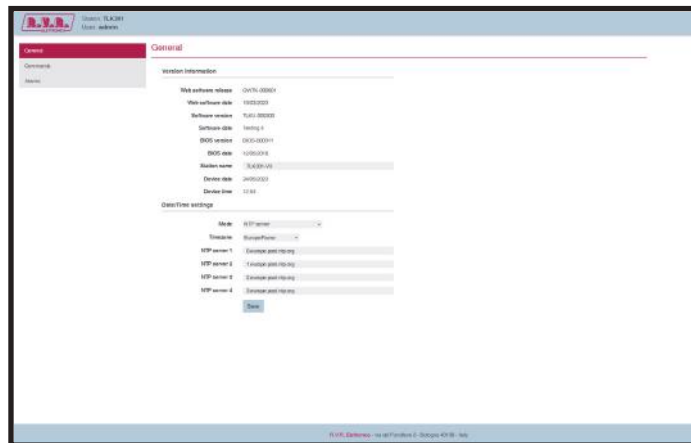

Menù 1



**Note :** If address ***http://192.168.0.244*** does not work, check and set IP address as ***192.168.0.XXX*** (where ***XXX*** is a figure between 1 and 254, excluding 244 that is **TLK301** interface default address). To change the IP address, follow the instructions in the manual or in the online guide and technical help, specific for the Operating System you use.

- 2) Modify the parameters in accordance with the own needs.
- 3) Now interface is ready to remotely read data and modify the various settings of the equipment.

## 8.1 Management Software

- 1) After access is made, the **General menu** (main page) opens and shows possible viewing options. This picture shows the **General menu** after access:

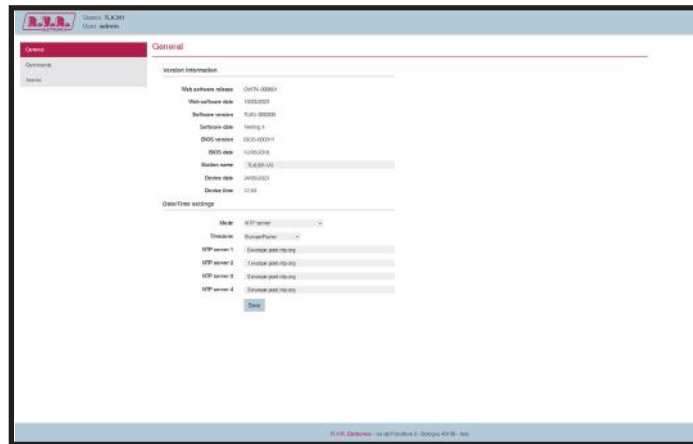

Menu 1

To enter in one of the sub-menus, select the name and then click on item to enter.

To go back to **General menu**, just press the F5 key on your computer's keyboard to force the WEB page reload.

The page that appears is divided into four frames:

- 1) **Title**: it has the logo, the identification of the equipment and the type of user (user, operator or administrator). It is located on the top of the page.  
At the top right it is possible to change the language of the menus (between English and Italian) and it is possible to session log out or restart the **TLK301**.
- 2) **Navigation menu**: it allows you to select the page to display.  
To enter into a submenu, select the name and then click on the item to enter.
- 3) **Body**: area where the page displays information about the selected menu.
- 4) **Subscript**: section where the page displays information about the company.

Graphical elements, common to all the menus, are briefly described below:

## LEVEL METER



Channel and modulation input levels are represented by vertical bars located on the right side of the field.

Alongside there are some numbers which have the function of indicating the level expressed in kHz.

## INDICATORS



Shows the observed measurement condition.

Red: alarm condition or data block

Grey: data inactivity condition

Yellow: data attention condition

Green: operating condition or data activity

## SELECTION AREA

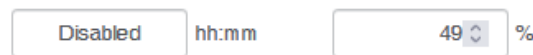

The data values to be modified can be entered inside this area.

The data can be entered by typing the value directly in the format described on the right of the field, or it can be changed using the UP and DOWN arrows, if present.

The changed data will not be updated until it is approved using the CONFIRMATION BUTTON immediately below.

## CONFIRMATION BUTTON

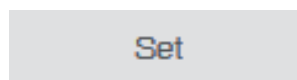

The changed data will not be modified until it is approved via the **CONFIRMATION BUTTON** located immediately under the **SELECTION AREA** described above. The previously saved data will keep in case you not confirm the failure.

## 8.1.1 General Menu - User

Values found here are “live readings”, and as such they can not be modified. To change the settings, use the **operator** or **administrator General** menu.

This page shows the user the data of **TLK301** interface:

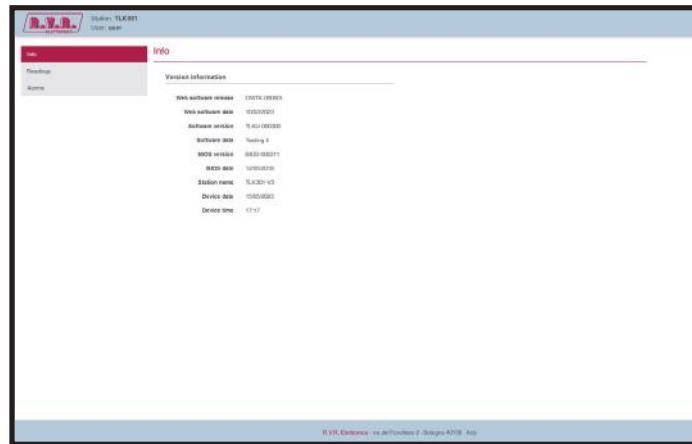

Menù 2

Web Software Release

Shows the release of WEB firmware.

Web Software Date

Shows the issue date of WEB firmware.

Software Version

Shows the firmware version of the equipment.

Software Date

Shows the issue date of the equipment firmware (dd/MM/yyyy).

BIOS Version

Shows the BIOS version of the equipment.

BIOS Date

Shows the BIOS release date of the equipment (dd/MM/yyyy).

Station Name

Shows the ID name of transmitting station.

Device Date

Shows the day stored on the equipment (dd/MM/yyyy).

Device Time

Shows the time stored on the equipment (hh:mm).

## 8.1.2 Readings Menu - User

Values found here are “live readings”, and as such they can not be modified. To change the settings, use the **operator** or **administrator Command Menu**.

The upper part allows you to enable or disable the Auto-refresh by clicking on the relevant box.

With Auto-refresh enabled the measures are taken every 5/15/30/60 seconds and gave available in a legible form by the current page.

With Auto-refresh disabled the measures are frozen at the time when you uncheck the box and gave available in a legible form by the current page.

This page shows the user the data collected by the **TLK301** interface:

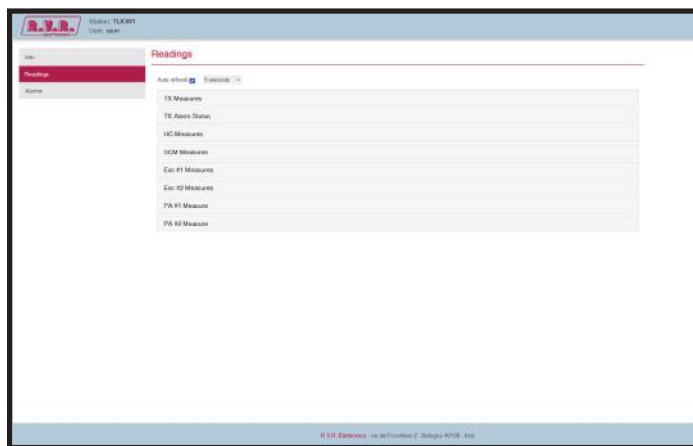

Menu 3



**Note:** The #n next to the EXC or PA wording referred to the number of the exciter or amplifier to which the measurement refers.

The measurements are collected in tabs regarding either the entire station or the individual equipments that make it up according to your needs. To be able to read or modify those of interest, just click on the relative name to expand.

### 8.1.2.1 TX Measures tab - User

TX Measures					
9609 W TX Forward Power	122 W TX Reflected Power	1026 W TX Unbalanced Power	<input checked="" type="checkbox"/> TX ON Status	<input type="checkbox"/> TX OFF Status	<input checked="" type="checkbox"/> Remote
38 °C TX Temperature		8 Config	<input checked="" type="checkbox"/> NOM Power	<input type="checkbox"/> LOW Power	<input type="checkbox"/> FaultReset
Disabled hh:mm Time to LOW	Disabled hh:mm Time to NOM	49 % Level LOW	100 % Level NOM	92.00 MHz EXC Freq.	80 % EXC.Power

- TX Forward Power  
Shows station forward power expressed in W.
- TX Reflected Power  
Shows station reflected power expressed in W
- TX Unbalanced Power  
Shows station unbalanced power expressed in W.
- Set ON Status  
Shows the data logical state.
- Set OFF Status  
Shows the data logical state.
- Remote  
Shows the data logical state
- TX Temperature  
Shows station internal temperature reading expressed in °C.
- Config  
Shows the set configuration of the station indicated.
- NOM Power  
Shows the data logical state.
- LOW Power  
Shows the data logical state.
- Fault/Reset  
Shows the presence of alarms on the station.
- Time to LOW  
Shows the data status and set time expressed in hh:mm.
- Time to NOM  
Shows the data status and set time expressed in hh:mm.
- Level LOW  
Shows the data power expressed in percentage.
- Level NOM  
Shows the data power expressed in percentage.
- Exc x Freq.  
Shows operating frequency of the station expressed in MHz.
- Exc Power  
Shows operating power of the station expressed in percentage.



## 8.1.2.2 TX Alarm Status tab - User

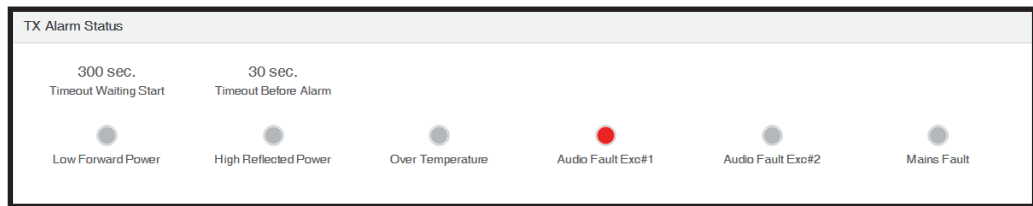

### Timeout Waiting Start

Shows the time to wait before starting alarm verification expressed in seconds.

### Timeout Before Alarm

Shows the persistence time of the alarm before it is considered as such expressed in seconds.

### LOW Forward Power

Shows the data logical state.

### High Reflected Power

Shows the data logical state.

### Over Temperature

Shows the data logical state.

### Audio Fault Exc #n

Shows the data logical state of the exciter indicated.

### Mains Fault

Shows the data logical state.

## 8.1.2.3 HC Measures tab - User

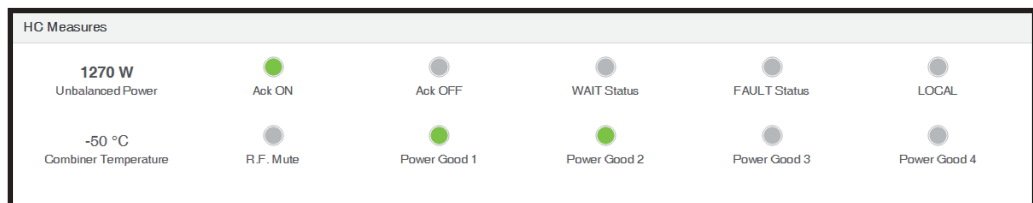

### Unbalanced Power

Shows the unbalanced power of the hybrid coupler expressed in W.

### Ack ON

Shows the data logical state.

### Ack OFF

Shows the data logical state.

### WAIT Status

Shows the data logical state.

FAULT Status

Shows the data logical state.

LOCAL

Shows the data logical state.

Combiner Temperature

Shows the internal temperature reading of the hybrid coupler expressed in °C.

R.F. Mute

Shows the data logical state.

Power Good n

Shows the data logical state of the hybrid coupler indicated.

#### 8.1.2.4 SCM Measures tab - User

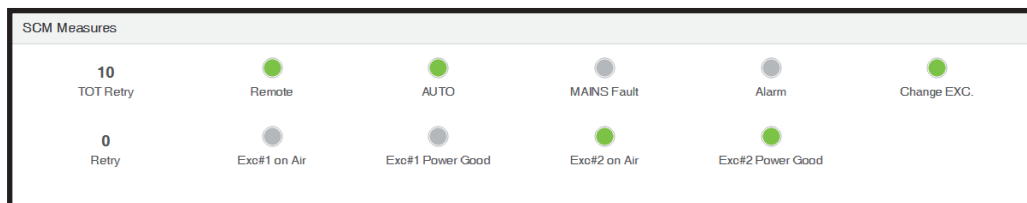

Tot Retry

Shows the number of total retries before Switching to manual.

Remote

Shows the data logical state.

AUTO

Shows the data logical state.

MAINS Fault

Shows the data logical state.

Alarm

Shows the data logical state.

Change EXC.

Shows the data logical state.

Retry

Shows the current number of retry.

EXC.#n on air

Shows the data logical state of the exciter indicated.

Exc#n Power Good on air

Shows the data logical state of the exciter indicated.

## 8.1.2.5 Exc #n Measures tab - User

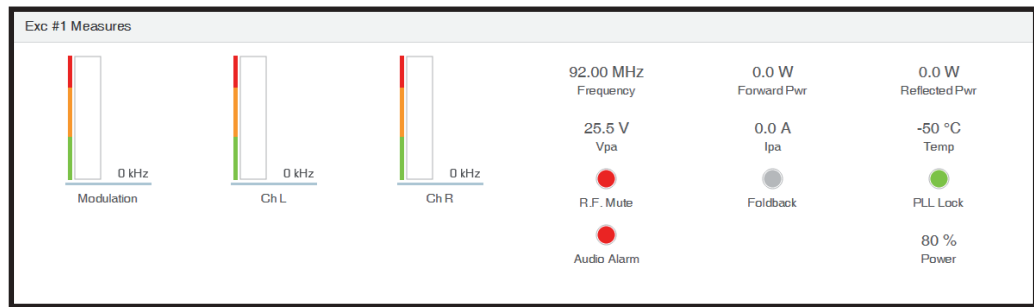

Modulation Exc#n

Shows exciter modulation expressed in kHz.

Ch L Exc#n

Shows modulation on left channel of the exciter indicated expressed in kHz.

Ch R Exc#n

Shows modulation on right channel of the exciter indicated expressed in kHz.

Frequency Exc#n

Shows operating frequency of the exciter indicated expressed in MHz.

Forward Pwr Exc#n

Shows the forward power of the exciter indicated expressed in kW.

Reflected Pwr Exc#n

Shows the reflected power of the exciter indicated expressed in kW.

Vpa Exc#n

Shows amplifier module of the exciter indicated voltage expressed in V.

Ipa Exc#n

Shows amplifier module current of the exciter indicated expressed in A.

Temp Exc#n

Shows the internal temperature reading of the exciter expressed in °C.

R.F. Mute

Shows the data logical state.

Foldback

Shows the data logical state.

PLL Lock

Shows the data logical state.

Audio Alarm  
Shows the data logical state.

Power Exc#n  
Shows operating power of the exciter expressed in percentage.

8.1.2.6 PA #n Measures tab - User

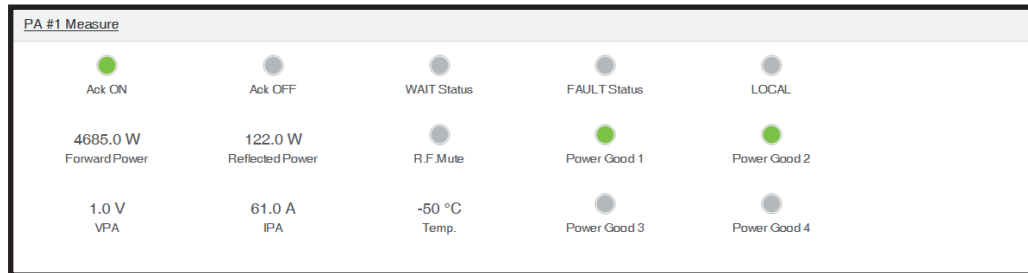

Ack ON  
Shows the data logical state.

Ack OFF  
Shows the data logical state.

WAIT Status  
Shows the data logical state.

FAULT Status  
Shows the data logical state.

LOCAL  
Shows the data logical state.

Forward Power  
Shows the forward power of the amplifier indicated expressed in kHz.

Reflected Power  
Shows the reflected power of the amplifier indicated expressed in kHz.

R.F.Mute  
Shows the data logical state.

Power Good n  
Shows the data logical state of the amplifier indicated.

VPA  
Shows amplifier module of the amplifier indicated voltage expressed in V.

IPA  
Shows amplifier module current of the amplifier indicated expressed in A.

## 8.1.3 Alarm List Menu - User

Values found here are “live readings”, and as such they can not be modified. To change the settings, use the menu **Alarms ► Reset operator or administrator**.

Within this menu it is possible to view all the alarms stored by the system: each new event will automatically cancel the older ones.

This page shows the user the alarms of the exciter connected to the **TLK301** interface:

Type	Name	Time	Date	Counter
0	Audio Alarm 2	12:21:00	2023-06-13	41
0	Low-Frequency power 1	12:20:00	2023-06-13	40
3	Audio Alarm 1	11:26:00	2023-03-03	39
3	Audio Alarm 1	13:26:00	2023-02-13	38
1	High-Frequency power 1	11:26:00	2023-02-13	37
0	Low-Frequency power 1	11:26:00	2023-02-13	36
3	Audio Alarm 1	17:18:00	2023-03-09	35
0	Audio Alarm 1	16:01:00	2023-02-09	34
0	Low-Frequency power 1	16:40:00	2023-02-09	33
0	Audio Alarm 2	16:30:00	2023-02-09	32
0	Low-Frequency power 1	16:34:00	2023-02-09	31
3	Audio Alarm 1	13:40:00	2023-02-09	30
0	Audio Alarm 2	13:30:00	2023-02-09	29
0	Audio Alarm 2	13:10:00	2023-02-09	28
3	Audio Alarm 1	11:14:00	2023-02-09	27
3	Audio Alarm 1	08:37:00	2023-02-09	26
0	Low-Frequency power 1	08:28:00	2023-02-09	25
0	Low-Frequency power 1	02:30:00	2023-02-09	24
0	Audio Alarm 2	14:42:00	2023-02-08	23
0	Low-Frequency power 1	13:54:00	2023-01-03	22

Menu 4

Type

Shows the alarm code.

Name

Shows the description for the error that led to even.

Time

Shows event recording time (hh:mm).

Date

Shows the day event was recorded (dd/MM/yyyy).

Counter

Shows progressive number for event recording.

## 8.1.4 General Menu - Operator & Administrator



**Note :** Access to this menu and modification of these parameters are only possible after login with operator or administrator rights.

This page not only shows the user information on the **TLK301** interface, but also allows you to set various parameters.

Below there is a description of the items that allow modification of the parameter, with respect to the General menu - User. Press the buttons to confirm your choice; if you let timer to time out, the parameter setting will remain as previously set:

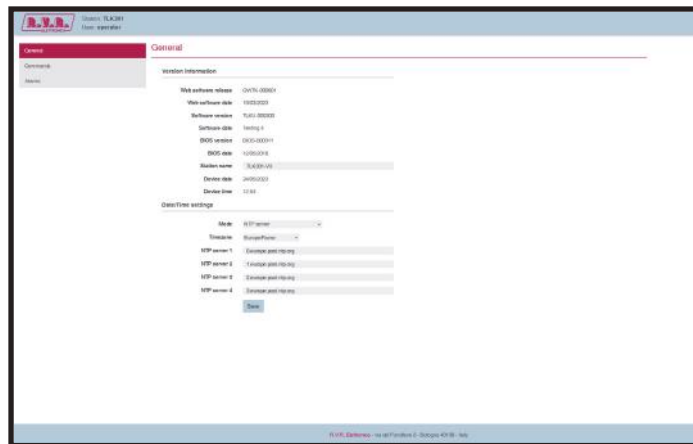

Menu 5

Web Software Release

Shows the release of WEB firmware.

Web Software Date

Shows the issue date of WEB firmware.

Software Version

Shows the firmware version of the equipment.

Software Date

Shows the issue date of the equipment firmware (dd/MM/yyyy).

BIOS Version

Shows the BIOS version of the equipment.

BIOS Date

Shows the BIOS release date of the equipment (dd/MM/yyyy).

Station Name

Setting of the name station. Write in the box the name that you want to assign and then press the **Save** button to apply your choice.

Device Date

Shows the day stored on the equipment (dd/MM/yyyy).

Device Time

Shows the time stored on the equipment (hh:mm).

## Mode

Selection of the time synchronization mode between **NTP server** (remote automatic synchronization with Network Time Protocol server) or **Local date/time synchronization** (local synchronization). Press the **Save** button to apply your choice.

## Timezone

Selection of the time zone area. Press the **Save** button to apply your choice.

## NTP server n

This menu is active only if **NTP server** mode has been selected.

Setting of the web address of the NTP server indicated. Write in the box the address that you want to assign and then press the **Save** button to apply your choice.

## Synchronization

This menu is active only if **Local date/time synchronizazition** mode has been selected.

Allows you to align the time stored in the device with that of the navigation system, by pressing the **Synchronization** button or synchronize the clock (hh:mm); or press the **Save** button to apply your choice.

## 8.1.5 Commands Menu - Operator & Administrator



**Note :** Access to this menu and modification of these parameters are only possible after login with operator or administrator rights.

This page not only shows the user information about the system connected to the **TLK301** interface, but also allows you to set various parameters.

The upper part allows you to enable or disable the Auto-refresh by clicking on the relevant box.

With Auto-refresh enabled the measures are taken every 5/15/30/60 seconds and gave available in a legible form by the current page.

With Auto-refresh disabled the measures are frozen at the time when you uncheck the box and gave available in a legible form by the current page.

Below there is a description of the items that allow modification of the parameter, with respect to the Readings menu - User. Press the buttons to confirm your choice; if you let timer to time out, the parameter setting will remain as previously set:

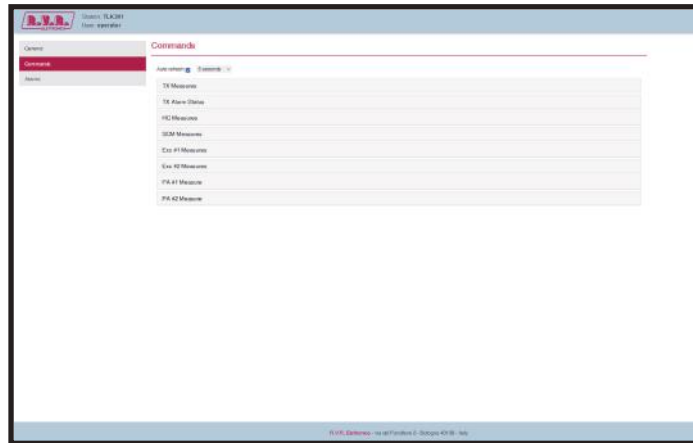

Menu 6



**Note:** The #n next to the EXC or PA wording referred to the number of the exciter or amplifier to which the measurement refers.

### 8.1.5.1 TX Measures tab - Operator & Administrator

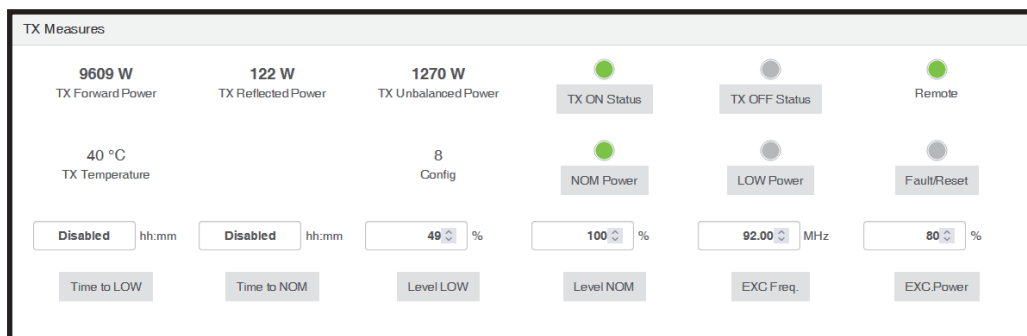

**TX Forward Power**

Shows station forward power expressed in W.

**TX Reflected Power**

Shows station reflected power expressed in W

**TX Unbalanced Power**

Shows station unbalanced power expressed in W.

**Set ON Status**

Press the button to change the logical state of the data.

**Set OFF Status**

Press the button to change the logical state of the data.

**Remote**

Shows the data logical state.

**TX Temperature**

Shows station internal temperature reading expressed in °C.



Config

Shows the set configuration of the station indicated.

NOM Power

Press the button to change the logical state of the data.

LOW Power

Press the button to change the logical state of the data.

Fault/Reset

Press the button to reset the the station alarms.

Time to LOW

Setting of the time to activate the LOWER POWER expressed in hh:mm.  
Press the button to confirm the data.

Time to NOM

Setting of the time to activate the NOMINAL POWER expressed in hh:mm. Press the button to confirm the data.

Level LOW

Setting of the time to activate the LOWER POWER expressed in percentage. Press the button to confirm the data.

Level NOM

Setting of the time to activate the NOMINAL POWER expressed in percentage. Press the button to confirm the data.

Exc x Freq.

Setting of the station operating frequency expressed in MHz. Press the button to confirm the data.

Exc Power

Setting of the station operating power expressed in percentage. Press the button to confirm the data.

## 8.1.5.2 TX Alarm Status tab - Operator & Administrator

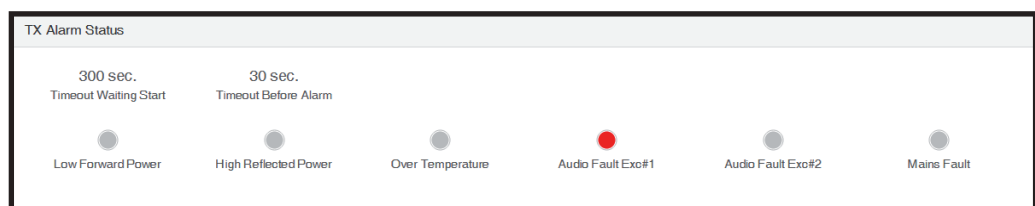

Timeout Waiting Start

Shows the time to wait before starting alarm verification expressed in seconds.

Timeout Before Alarm

Shows the persistence time of the alarm before it is considered as such expressed in seconds.

LOW Forward Power  
Shows the data logical state.

High Reflected Power  
Shows the data logical state.

Over Temperature  
Shows the data logical state.

Audio Fault Exc #n  
Shows the data logical state of the exciter indicated.

Mains Fault  
Shows the data logical state.

### 8.1.5.3 HC Measures tab - Operator & Administrator

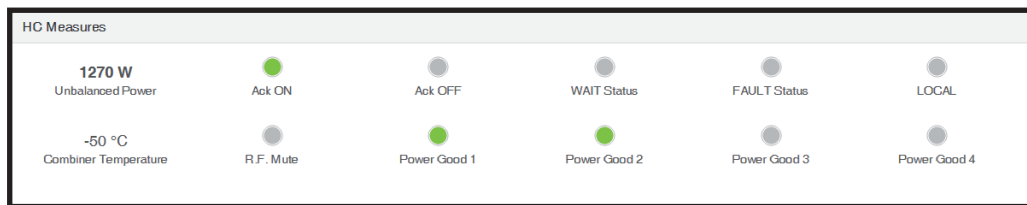

Unbalanced Power  
Shows the unbalanced power of the hybrid coupler expressed in W.

Ack ON  
Shows the data logical state.

Ack OFF  
Shows the data logical state.

WAIT Status  
Shows the data logical state.

FAULT Status  
Shows the data logical state.

LOCAL  
Shows the data logical state.

Combiner Temperature  
Shows the internal temperature reading of the hybrid coupler expressed in °C.

R.F. Mute  
Shows the data logical state.

Power Good n  
Shows the data logical state of the hybrid coupler indicated.

## 8.1.5.4 SCM Measures tab - Operator & Administrator

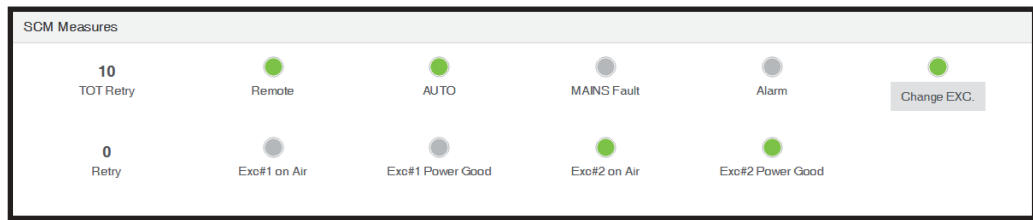

Tot Retry

Shows the number of total retries before Switching to manual.

Remote

Shows the data logical state.

AUTO

Shows the data logical state.

MAINS Fault

Shows the data logical state.

Alarm

Shows the data logical state.

Change EXC.

Press the button to change the logical state of the data.

Retry

Shows the current number of retry.

EXC.#n on air

Shows the data logical state of the exciter indicated.

Exc#n Power Good on air

Shows the data logical state of the exciter indicated.

## 8.1.5.5 Exc #n Measures tab - Operator & Administrator

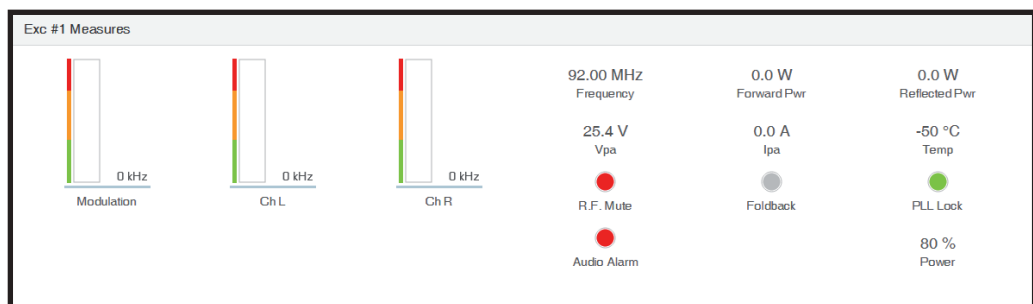

Modulation Exc#n

Shows exciter modulation expressed in kHz.

- Ch L Exc#n  
Shows modulation on left channel of the exciter indicated expressed in kHz.
- Ch R Exc#n  
Shows modulation on right channel of the exciter indicated expressed in kHz.
- Frequency Exc#n  
Shows operating frequency of the exciter indicated expressed in MHz.
- Forward Pwr Exc#n  
Shows the forward power of the exciter indicated expressed in kHz.
- Reflected Pwr Exc#n  
Shows the reflected power of the exciter indicated expressed in kHz.
- Vpa Exc#n  
Shows amplifier module of the exciter indicated voltage expressed in V.
- Ipa Exc#n  
Shows amplifier module current of the exciter indicated expressed in A.
- Temp Exc#n  
Shows the internal temperature reading of the exciter expressed in °C.
- R.F. Mute  
Shows the data logical state.
- Foldback  
Shows the data logical state.
- PLL Lock  
Shows the data logical state.
- Audio Alarm  
Shows the data logical state.
- Power Exc#n  
Shows operating power of the exciter expressed in percentage.

8.1.5.6 PA #n Measures tab - Operator & Administrator

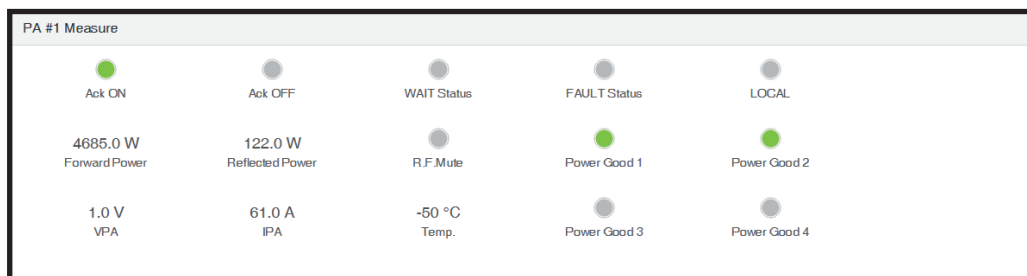

Ack ON	Shows the data logical state.
Ack OFF	Shows the data logical state.
WAIT Status	Shows the data logical state.
FAULT Status	Shows the data logical state.
LOCAL	Shows the data logical state.
Forward Power	Shows the forward power of the amplifier indicated expressed in kHz.
Reflected Power	Shows the reflected power of the amplifier indicated expressed in kHz.
R.F.Mute	Shows the data logical state.
Power Good n	Shows the data logical state of the amplifier indicated.
VPA	Shows amplifier module of the amplifier indicated voltage expressed in V.
IPA	Shows amplifier module current of the amplifier indicated expressed in A.

### 8.1.6 Alarms Menu - Operator & Administrator



**Note :** Access to this menu and modification of these parameters are only possible after login with operator or administrator rights.

Within this menu you can display the last 20 alarms saved by the system: any new event will automatically delete the older ones. Using **Reset** item at bottom left of the menu, you can delete all pending alarms.

This page shows to the user the alarms of the system connected to the **TLK301** interface:

Type	Name	Time	Date	Counter
4	Audio Alarm 2	17:33:00	2023-07-26	40
3	Audio Alarm 1	17:33:00	2023-07-26	39
5	DCM Fault	18:40:00	2023-07-12	88
4	Audio Alarm 2	17:08:00	2023-07-11	38
3	Audio Alarm 1	17:08:00	2023-07-11	37
0	Low Forward power 1	13:01:00	2023-06-30	37
0	Low Forward power 1	13:04:00	2023-06-30	36
4	Audio Alarm 2	12:30:00	2023-06-30	35
3	Audio Alarm 1	12:30:00	2023-06-30	34
4	Audio Alarm 2	12:15:00	2023-06-30	33
3	Audio Alarm 1	12:15:00	2023-06-30	32
4	Audio Alarm 2	11:00:00	2023-06-30	31
3	Audio Alarm 1	11:00:00	2023-06-30	30
4	Audio Alarm 2	10:30:00	2023-06-29	49
3	Audio Alarm 1	10:30:00	2023-06-29	48
3	Audio Alarm 1	11:00:00	2023-06-26	47
3	Audio Alarm 1	11:00:00	2023-06-14	46
3	Audio Alarm 1	11:00:00	2023-06-14	45
3	Audio Alarm 1	12:10:00	2023-05-22	44
4	Audio Alarm 2	10:30:00	2023-05-02	43

Menu 7

Type

Shows the alarm code.

Name

Shows the description for the error that led to even.

Time

Shows event recording time (hh:mm).

Date

Shows the day event was recorded (dd/MM/yyyy).

Counter

Shows progressive number for event recording.

## 8.1.7 Email Menù - Administrator



**Note :** Access to this menu and modification of these parameters are only possible after login with operator or administrator rights.

This page not only shows the user the information about sending messages through **TLK301** interface network connection, but also allows setting various parameters.

Press the **Save** button to confirm selection; if you let timer to time out, the parameter setting will remain as previously set.



**Note :** to make changes within these sub-menus you need to have through technical knowledge of network management. It is recommended to have changes performed by trained or qualified personnel.

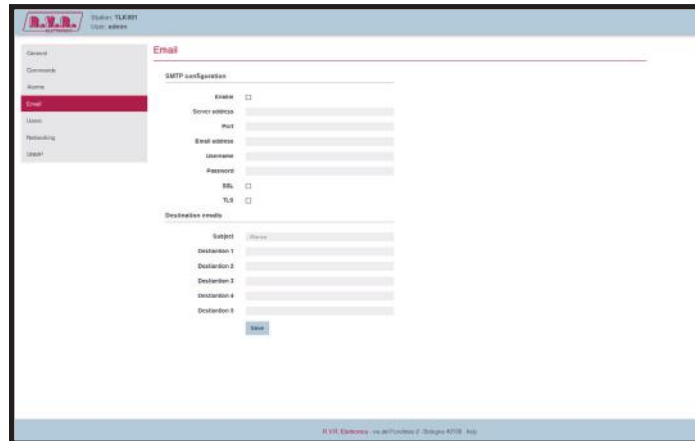

Menu 8

- Enable  
Enabling of SMTP Service Status.
- Server address  
Setting of the SMTP server address.
- Port  
Setting of the port to use with the SMTP server.
- Email address  
Setting of the transmission address used for sending messages.
- Username  
Setting of the user name for accessing to the SMTP server.
- Password  
Setting of the password for accessing to the SMTP server.
- SSL  
Enabling of the utilization of SSL protocols on the SMTP server.
- TLS  
Enabling of the utilization of TLS protocols on the SMTP server.
- Subject  
Setting of the “subject” field description of the mail in case of sending alarm messages.
- Destination 1  
Setting of the first email address to which alarm warning mail messages shall be sent.
- Destination 2  
Setting of the second email address to which alarm warning mail messages shall be sent.

Destination 3

Setting of the third email address to which alarm warning mail messages shall be sent

Destination 4

Setting of the fourth email address to which alarm warning mail messages shall be sent

Destination 5

Setting of the fifth email address to which alarm warning mail messages shall be sent

### 8.1.8 Users Menu - Administrator



**Note :** Access to this menu and modification of these parameters are only possible after login with operator or administrator rights.

This page allows the configuration of login as an administrator and maintenance of **TLK301** interface via WUI.

Press the **Save** button to confirm selection; if you let timer to time out, the parameter setting will remain as previously set.

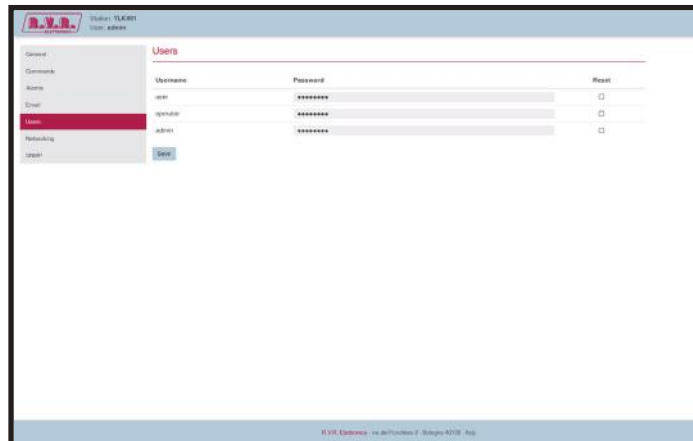

Menu 9

User Password

Setting of the password for user functions (parameter read-only enabling). The **Reset** button allows you to delete the password set.

Operator Password

Setting of the password for operator functions (parameter reading and partial change enabling). The **Reset** button allows you to delete the password set.

Admin Password

Setting of the password for administrator functions (parameter reading and full change enabling). The **Reset** button allows you to delete the password set.



## 8.1.9 Network Menu - Administrator



**Note :** Access to this menu and modification of these parameters are only possible after login with operator or administrator rights.

This page not only shows the user the information about **TLK301** interface network connection, but also allows setting various parameters.

Press the **Save** button to confirm selection; if you let timer to time out, the parameter setting will remain as previously set.



**Note :** to make changes within these sub-menus you need to have through technical knowledge of network management. It is recommended to have changes performed by trained or qualified personnel.



**Note:** The IP address must be set to static and does not have the opportunity to acquire an address from DHCP server on network.

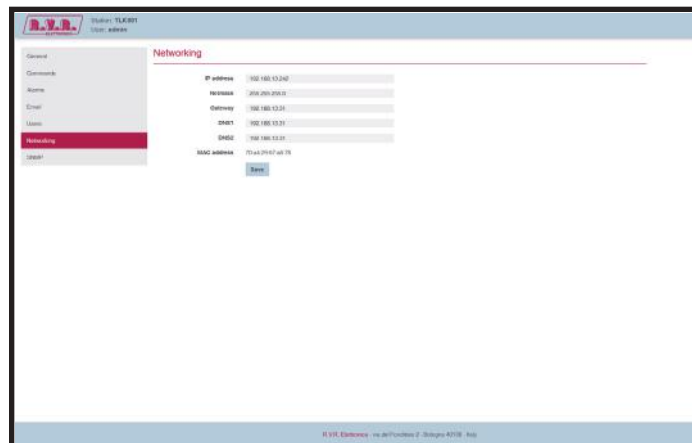

Menu 10

### IP address

Setting of the number that unequivocally identifies, within a single network, the devices connected to an IT network that uses the IP standard (Internet Protocol).

### Netmask

Setting of the subnet mask, necessary for the computer that must communicate with another IP address to know if it should route packages toward the gateway of its local network or use the address of the receiver local network.

### Gateway

Setting of the gateway address. In simpler networks, there is only one gateway that forwards to the internet network all the outbound traffic. In more complicated networks where many subnets are available, each of them refers to a gateway that will route data traffic towards the other subnets or forward it to other gateways.

## DNS1 server

Setting of the first DNS server address (Domain Name System); in case the server should change the server hosting a service, or it is necessary to change its IP address, it is enough to change the DNS record, without changing client settings.

## DNS2 server

Setting of the second DNS server address (Domain Name System); in case the server should change the server hosting a service, or it is necessary to change its IP address, it is enough to change the DNS record, without changing client settings.

## MAC Address

Shows the MAC (Media Access Control) address; this address is uniquely assigned to the ethernet network card present on exciter. It can be useful if you want to add in your router, or firewall, a list of MAC addresses of network cards authorized to connect to the network.

### 8.1.10 SNMP Menù - Administrator



**Note :** Access to this menu and modification of these parameters are only possible after login with operator or administrator rights.

This page not only shows the user the information relating to the management and supervision of devices connected to the network via SNMP (Simple Network Management Protocol) of **TLK301** interface, but also allows setting various parameters.

Press the **Save** button to confirm selection; if you let timer to time out, the parameter setting will remain as previously set.



**Note :** to make changes within these sub-menus you need to have through technical knowledge of network management. It is recommended to have changes performed by trained or qualified personnel.

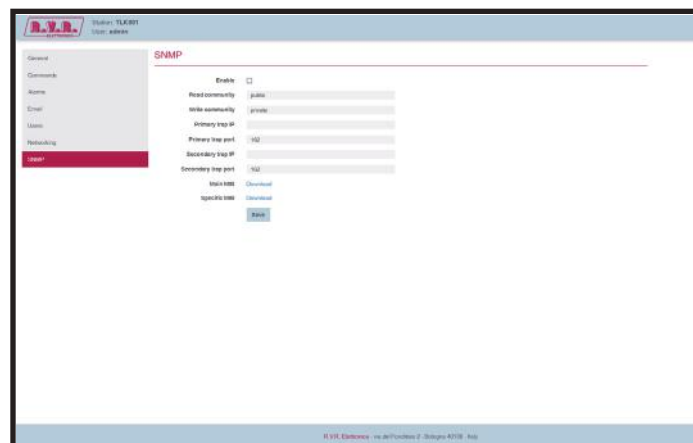

Menu 11

**Enable**

Enabling of the SNMP service status.

**Read Community**

Setting of the string for the SET command.

**Write Community**

Setting of the string for the GET command.

**Primary Trap IP**

Setting of the identification number of primary IP address set to send the Trap signaling. It must be in dotted format XXX.XXX.XXX.XXX (ie: 192.168.0.5).

**Primary Trap Port**

Viewing the first Trap destination with the Port to which alarm warning messages shall be sent. The destination port of the Trap can not be edited.

**Secondary Trap IP**

Setting of the identification number of secondary IP address set to send the Trap signaling. It must be in dotted format XXX.XXX.XXX.XXX (ie: 192.168.0.5).

Impostazione del numero identificativo dell'indirizzo IP secondario configurato a cui inviare la segnalazione Trap. Deve essere nel formato punteggiato XXX.XXX.XXX.XXX (esempio: 192.168.0.5).

**Secondary Trap Port**

Viewing the second Trap destination with the Port to which alarm warning messages shall be sent. The destination port of the Trap can not be edited.

**Main MIB**

The main MIB files of manufacturer of product stored in **TLK301** can be can be downloaded by pressing the **Download** onto your PC or browser device.

**Specific MIB**

The specific MIB files of product stored in **TLK301** can be can be downloaded by pressing the **Download** onto your PC or browser device.

## 9. Versions with GSM

This section describes the features introduced with versions /V2 and /V4 (option with GSM telemetry) and the necessary steps for their proper configuration.

These versions are able to handle remote the alarm reporting by sending SMS messages through a internal GSM modem or through a dial-up external PSTN modem (option on demand) by sending an alarm message string to a connected PC.

Before querying the system using SMS messages, establish a connection using the "TELECON" software and set the provider service centre number and the telephone numbers authorised to send these commands to the devices.

When any one of the parameters listed above changes state, a text message with the following information is sent via modem (if fitted):

- Station Name.
- Station ID.
- State of measurements.

ES1. (example of TLK**TLK301** in double exciter configuration with external switching unit)

*TLC ID:01-Station name-  
FwdPwr1 OK-  
RflPwr1 OK-  
Temp1 OK-  
Audio1 OK-  
Mains OK-  
SCM Fault OK-  
Audio2 OK-*

ES2. (example of **TLK301** in single exciter configuration)

*TLC ID:01-Station name-  
FwdPwr1 OK-  
RflPwr1 OK-  
Temp1 OK-  
Audio OK-  
Mains OK-*

The following table list the commands you can send:

Command	Response	Description
<b>INFO</b>	Station Name: (string 16char max) Station ID: (to 000 from 999) FWD Power: (Exciter Forward Power in W) RFL Power: (Exciter Reflected Power in W) Temp: (Temperature in °C) Tx ON (Tx state ON/OFF/STAND-BY) Local (Local, Remote) Alarm Present (Present/Absent)	Transmitter status information
<b>TXON</b>	Station Name: (string 16char max) Station ID: (from 000 to 999) Tx is ON, Fault Command	Transmitter power-on
<b>TXOFF</b>	Station Name: (string 16char max) Station ID: (from 000 to 999) Tx is OFF, Fault Command	Transmitter power-off
<b>ALARM</b>	Station Name: (string 16char max) Station ID: (to 000 from 999) Alarm: (Last 4 alarm list store in memory)	Alarm log
<b>RESET</b>	Station Name: (string 16char max) Station ID: (to 000 from 999) RESET stored Record	Clear Alarm Log
<b>STATUS</b>	Station Name: (string 16char max) Station ID: (to 000 from 999) Status: Resend status alarm message	Resend the alarm status information
<b>VERSION</b>	Station Name: (string 16char max) Station ID: (to 000 from 999) Release App, Release Bios, Table Code	Software Version informations

Table 9.2 - V2 and V4 versions



**Note:** Response time to SMS commands may vary with different GSM network providers; as a general rule, response time should not exceed 7-10 minutes maximum..

## 10. Configurations of Transmitter System

Below are listed the several possible system configurations, the configuration that needs to assume on the dip switch and the screens obtainable via WEB.



**Note:** for further information on the Dip Switch, please read the section on Dip Switch Configuration present in this manual.

### 10.1 Configuration of Transmitter from V1 to V4 Versions

#### 10.1.1 Configuration of System 01

ITEM OGGETTO	COMPOSITION COMPOSIZIONE	READINGS/COMMANDS MENU TABS SCHEDE MENU' READINGS/COMMANDS
1	TLK (telemetry/telemetria)	TX Measures TX Alarm Status
2	TEX-LCD (exciter/eccitatore)	Exc #n Measures

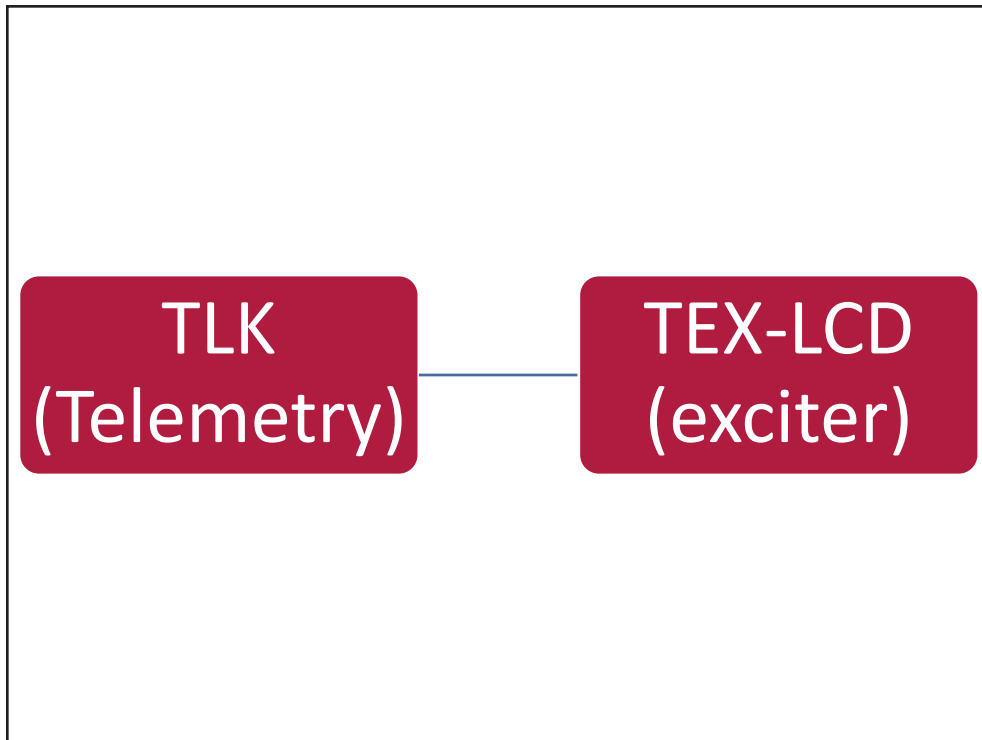

Configuration #01: **System**

#### 10.1.1.1 Configuration of Dip Switch for System 01

	1	2	3	4	5	6	7	8	1	2	3	4	5	6	7	8
Config TX 1									x							

Configuration #01: **Dip Switch**

10.1.1.2 I<sup>2</sup>C Address for System 01

adr	TEX#1	TEX#2	SCM	HC o PA	PA	PA	PA	PA	PA
<b>Config 01</b>	1								

*Configuration #01: I<sup>2</sup>C Address*

10.1.2 Configuration of System 02

ITEM OGGETTO	COMPOSITION COMPOSIZIONE	READINGS/COMMANDS MENU TABS SCHEDE MENU' READINGS/COMMANDS
1	TLK (telemetry/telemetria)	TX Measures TX Alarm Status
2	TEX-LCD (exciter/eccitatore)	Exc #n Measures
3	PJ (amplifier/amplificatore)	PA #n Measure

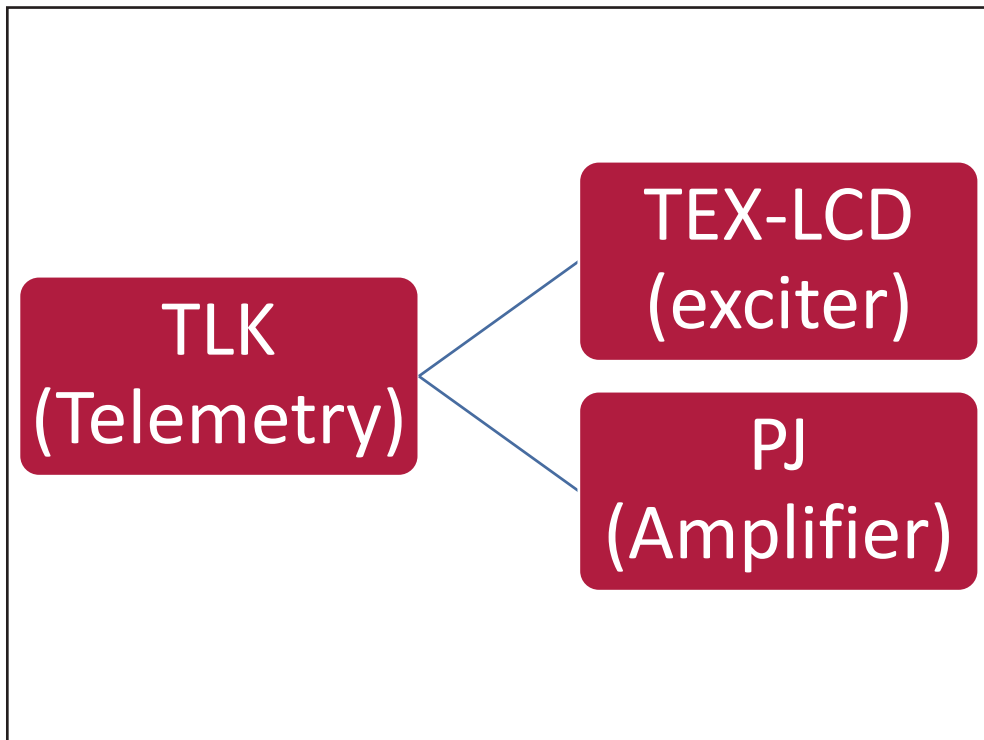

Configuration #02: **System**

10.1.2.1 Configuration of Dip Switch for System 02

	1	2	3	4	5	6	7	8	1	2	3	4	5	6	7	8
Config TX 2									x							

Configuration #02: **Dip Switch**

10.1.2.2 I<sup>2</sup>C Address for System 02

adr	TEX#1	TEX#2	SCM	HC o PA	PA	PA	PA	PA	PA
Config 02	1			4					

Configuration #02: **I<sup>2</sup>C Address**



## 10.1.3 Configuration of System 03

ITEM OGGETTO	COMPOSITION COMPOSIZIONE	READINGS/COMMANDS MENU TABS SCHEDE MENU' READINGS/COMMANDS
1	TLK (telemetry/telemetria)	TX Measures TX Alarm Status
2	TEX-LCD (exciter/eccitatore)	Exc #n Measures
3	HC-LCD (hybrid coupler/accoppiatore ibrido)	HC Measures
4	2x PJ (amplifier/amplificatore)	PA #n Measure PA #n Measure

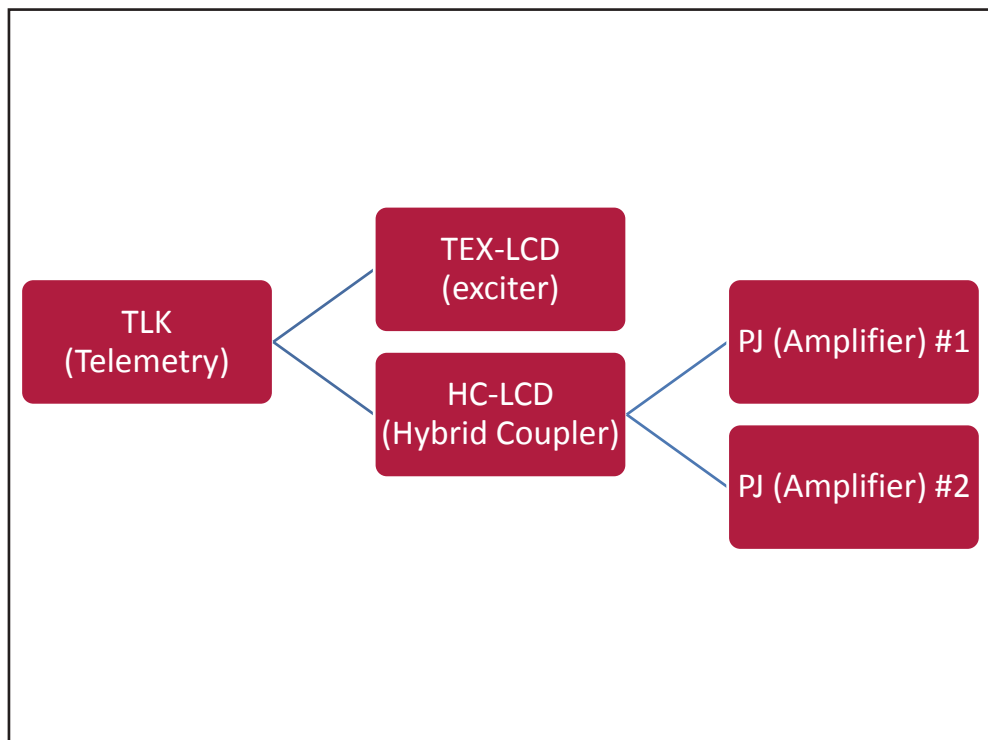

Configuration #03: **System**

### 10.1.3.1 Configuration of Dip Switch for System 03

	1	2	3	4	5	6	7	8	1	2	3	4	5	6	7	8
Config TX 3									x	x						

Configuration #03: **Dip Switch**

### 10.1.3.2 I<sup>2</sup>C Address for System 03

adr	TEX#1	TEX#2	SCM	HC o PA	PA	PA	PA	PA	PA
<b>Config 03</b>	1			4	5	6			

Configuration #03: **I<sup>2</sup>C Address**

10.1.4 Configuration of System 04

ITEM OGGETTO	COMPOSITION COMPOSIZIONE	READINGS/COMMANDS MENU TABS SCHEDE MENU' READINGS/COMMANDS
1	TLK (telemetry/telemetria)	TX Measures
2	TEX-LCD (exciter/eccitatore)	TX Alarm Status
3	HC-LCD (hybrid coupler/accoppiatore ibrido)	Exc #n Measures
4	3x PJ (amplifier/amplificatore)	HC Measures
		PA #n Measure
		PA #n Measure

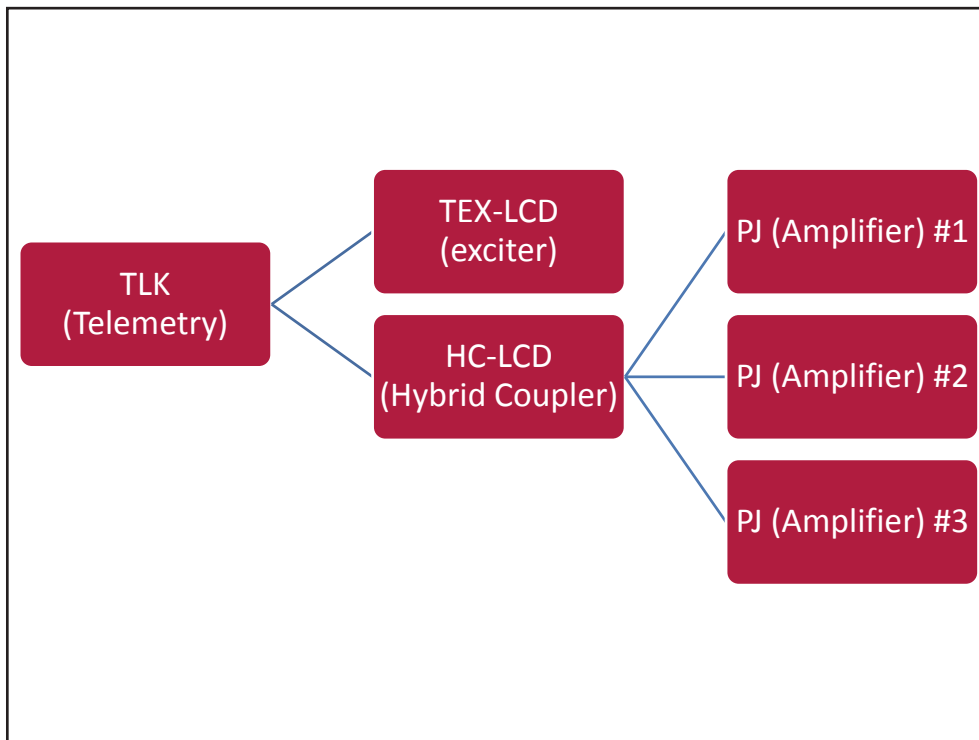

Configuration #04: System

10.1.4.1 Configuration of Dip Switch for System 04

	1	2	3	4	5	6	7	8	1	2	3	4	5	6	7	8
Config TX 4											x					

Configuration #04: Dip Switch

10.1.4.2 I<sup>2</sup>C Address for System 04

adr	TEX#1	TEX#2	SCM	HC o PA	PA	PA	PA	PA	PA
Config 04	1			4	5	6	7		

Configuration #04: I<sup>2</sup>C Address

## 10.1.5 Configuration of System 05

ITEM OGGETTO	COMPOSITION COMPOSIZIONE	READINGS/COMMANDS MENU TABS SCHEDE MENU' READINGS/COMMANDS
1	TLK (telemetry/telemetria)	TX Measures
		TX Alarm Status
2	TEX-LCD (exciter/eccitatore)	Exc #n Measures
3	HC-LCD (hybrid coupler/accoppiatore ibrido)	HC Measures
4	4x PJ (amplifier/amplificatore)	PA #n Measure
		PA #n Measure
		PA #n Measure
		PA #n Measure

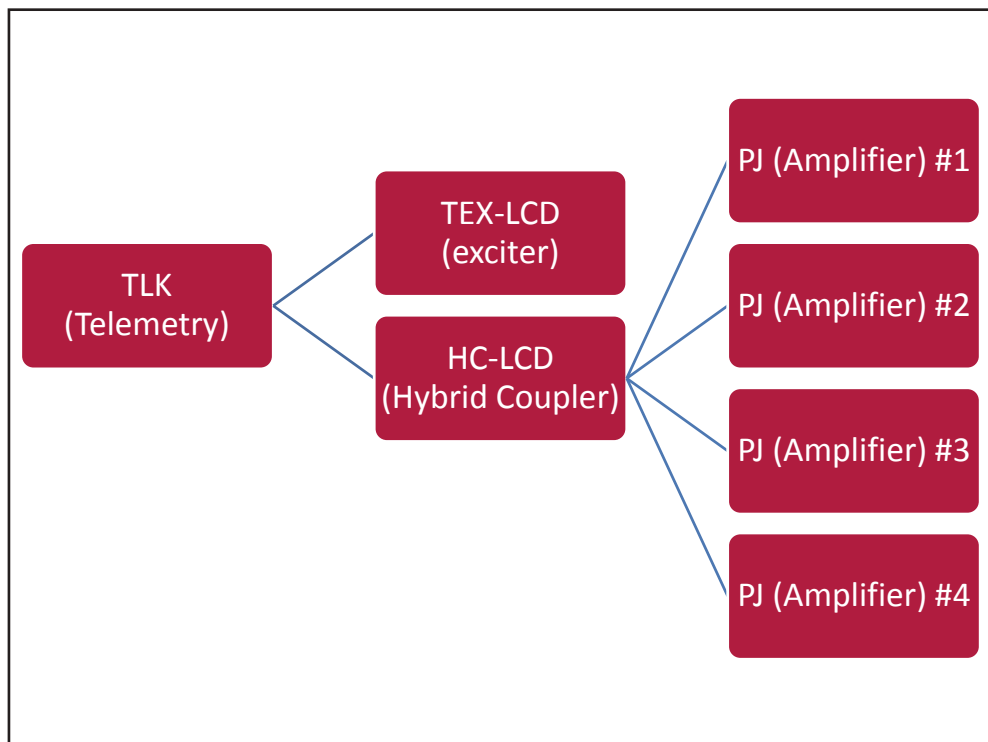

Configuration #05: **System**

### 10.1.5.1 Configuration of Dip Switch for System 05

	1	2	3	4	5	6	7	8	1	2	3	4	5	6	7	8
Config TX 5									x		x					

Configuration #05: **Dip Switch**

### 10.1.5.2 I<sup>2</sup>C Address for System 05

adr	TEX#1	TEX#2	SCM	HC o PA	PA	PA	PA	PA	PA
Config 05	1			4	5	6	7	8	

Configuration #05: **I<sup>2</sup>C Address**

10.1.6 Configuration of System 06

ITEM OGGETTO	COMPOSITION COMPOSIZIONE	READINGS/COMMANDS MENU TABS SCHEDE MENU' READINGS/COMMANDS
1	TLK (telemetry/telemetria)	TX Measures
		TX Alarm Status
2	TEX-LCD (exciter/eccitatore)	Exc #n Measures
3	HC-LCD (hybrid coupler/accoppiatore ibrido)	HC Measures
4	5x PJ (amplifier/amplificatore)	PA #n Measure
		PA #n Measure
		PA #n Measure
		PA #n Measure
		PA #n Measure

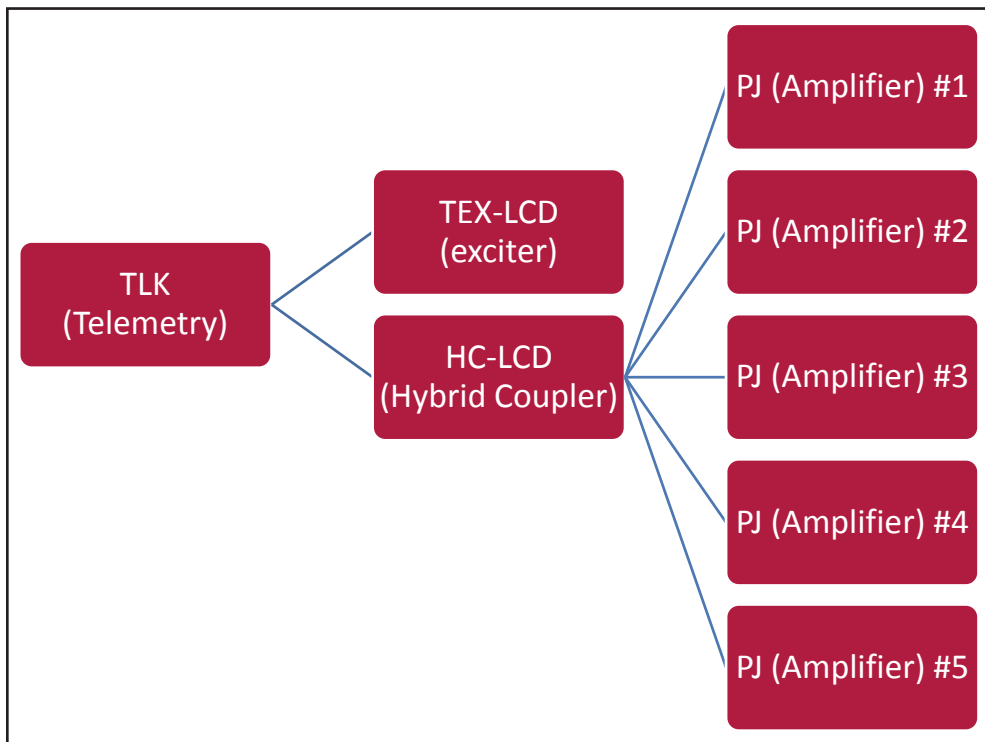

Configuration #06: System

10.1.6.1 Configuration of Dip Switch for System 06

	1	2	3	4	5	6	7	8	1	2	3	4	5	6	7	8
Config TX 6										x	x					

Configuration #06: Dip Switch

10.1.6.2 I<sup>2</sup>C Address for System 06

adr	TEX#1	TEX#2	SCM	HC o PA	PA	PA	PA	PA	PA
Config 06	1			4	5	6	7	8	9

Configuration #06: I<sup>2</sup>C Address

## 10.1.7 Configuration of System 07

ITEM OGGETTO	COMPOSITION COMPOSIZIONE	READINGS/COMMANDS MENU TABS SCHEDE MENU' READINGS/COMMANDS
1	TLK (telemetry/telemetria)	TX Measures
		TX Alarm Status
2	SCM-LCD (changeovere/ scambiatore)	SCM Measures
3	2x TEX-LCD (exciter/eccitatore)	Exc #n Measures
		Exc #n Measures
4	PJ (amplifier/amplificatore)	PA #n Measure

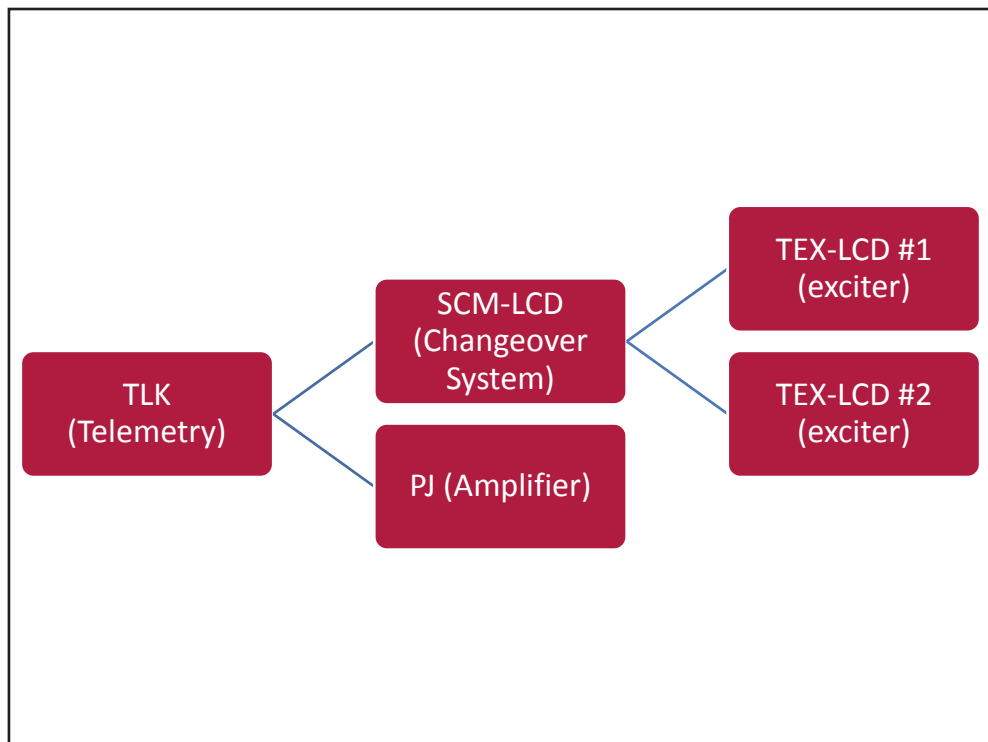

Configuration #07: System

### 10.1.7.1 Configuration of Dip Switch for System 07

	1	2	3	4	5	6	7	8	1	2	3	4	5	6	7	8
Config TX 7									x	x	x					

Configuration #07: Dip Switch

### 10.1.7.2 I<sup>2</sup>C Address for System 07

adr	TEX#1	TEX#2	SCM	HC o PA	PA	PA	PA	PA	PA
Config 07	1	2	3	4					

Configuration #07: I<sup>2</sup>C Address

10.1.8 Configuration of System 08

ITEM OGGETTO	COMPOSITION COMPOSIZIONE	READINGS/COMMANDS MENU TABS SCHEDE MENU' READINGS/COMMANDS
1	TLK (telemetry/telemetria)	TX Measures
		TX Alarm Status
2	SCM-LCD (changeovere/ scambiatore)	SCM Measures
3	2x TEX-LCD (exciter/eccitatore)	Exc #n Measures
		Exc #n Measures
4	HC-LCD (hybrid coupler/accoppiatore ibrido)	HC Measures
5	2x PJ (amplifier/amplificatore)	PA #n Measure
		PA #n Measure

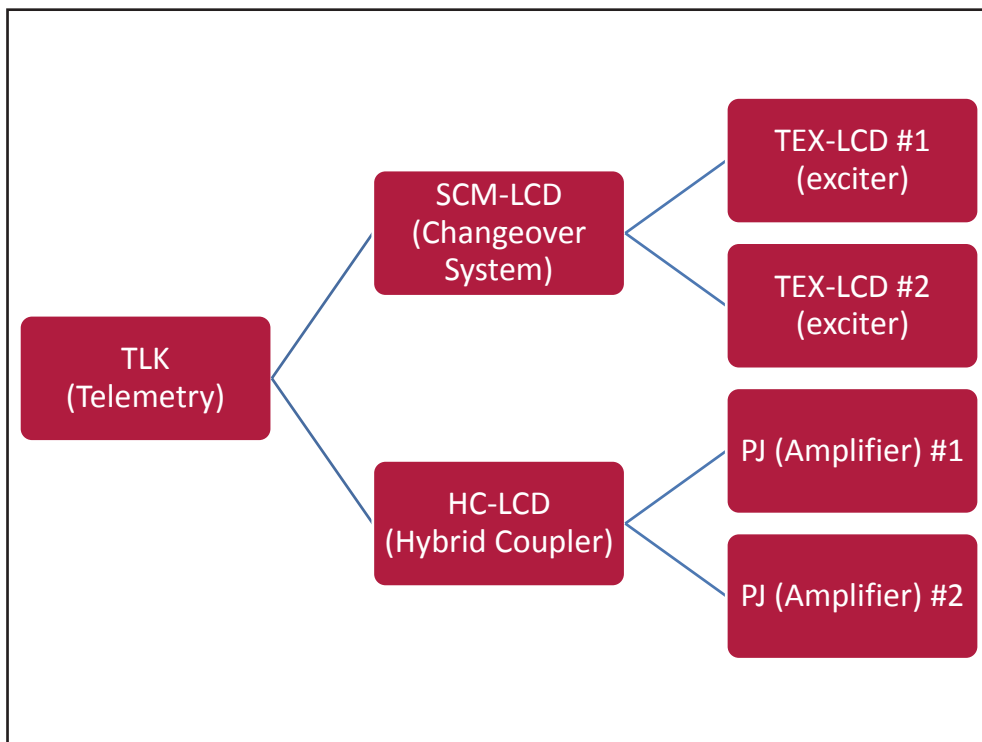

Configuration #08: **System**

10.1.8.1 Configuration of Dip Switch for System 08

	1	2	3	4	5	6	7	8	1	2	3	4	5	6	7	8
Config TX 8												x				

Configuration #08: **Dip Switch**

10.1.8.2 I<sup>2</sup>C Address for System 08

adr	TEX#1	TEX#2	SCM	HC o PA	PA	PA	PA	PA	PA
Config 08	1	2	3	4	5	6			

Configuration #08: **I<sup>2</sup>C Address**

## 10.1.9 Configuration of System 09

ITEM OGGETTO	COMPOSITION COMPOSIZIONE	READINGS/COMMANDS MENU TABS SCHEDE MENU' READINGS/COMMANDS
1	TLK (telemetry/telemetria)	TX Measures TX Alarm Status
2	SCM-LCD (changeover/ scambiatore)	SCM Measures
3	2x TEX-LCD (exciter/eccitatore)	Exc #n Measures Exc #n Measures
4	HC-LCD (hybrid coupler/accoppiatore ibrido)	HC Measures
5	3x PJ (amplifier/amplificatore)	PA #n Measure PA #n Measure PA #n Measure

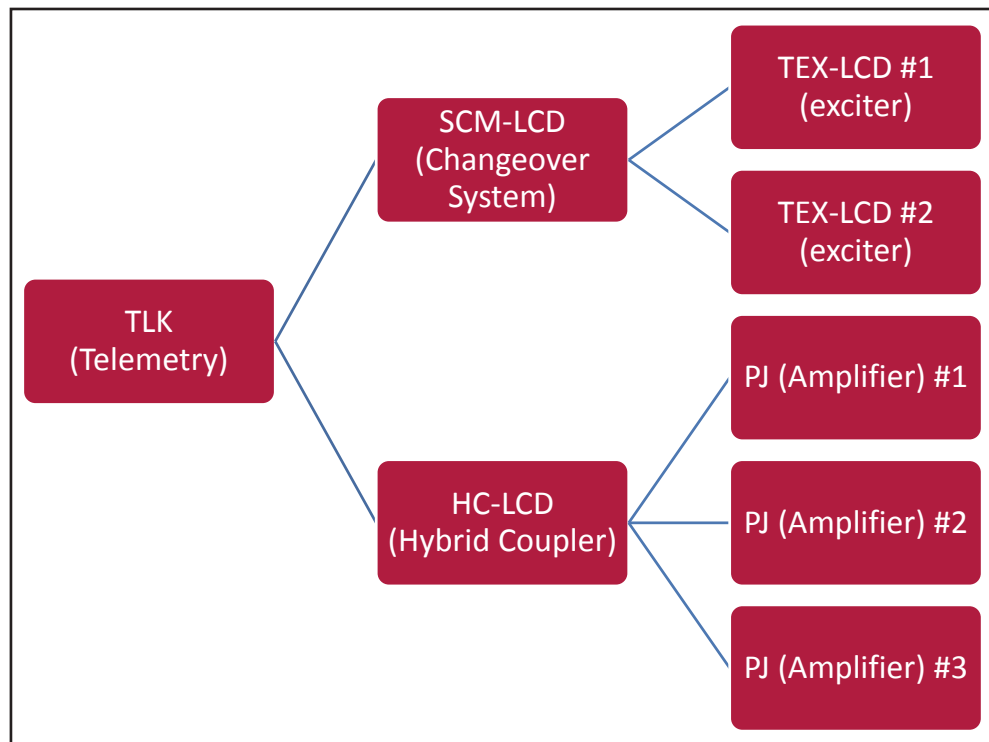

Configuration #09: **System**

### 10.1.9.1 Configuration of Dip Switch for System 09

	1	2	3	4	5	6	7	8	1	2	3	4	5	6	7	8
Config TX 9									x			x				

Configuration #09: **Dip Switch**

## 10.1.9.2 I<sup>2</sup>C Address for System 09

adr	TEX#1	TEX#2	SCM	HC o PA	PA	PA	PA	PA	PA
<b>Config 09</b>	1	2	3	4	5	6	7		

*Configuration #09: I<sup>2</sup>C Address*



## 10.1.10 Configuration of System 10

ITEM OGGETTO	COMPOSITION COMPOSIZIONE	READINGS/COMMANDS MENU TABS SCHEDE MENU' READINGS/COMMANDS
1	TLK (telemetry/telemetria)	TX Measures TX Alarm Status
2	SCM-LCD (changeovere/ scambiatore)	SCM Measures
3	2x TEX-LCD (exciter/eccitatore)	Exc #n Measures Exc #n Measures
4	HC-LCD (hybrid coupler/accoppiatore ibrido)	HC Measures
5	4x PJ (amplifier/amplificatore)	PA #n Measure PA #n Measure PA #n Measure PA #n Measure

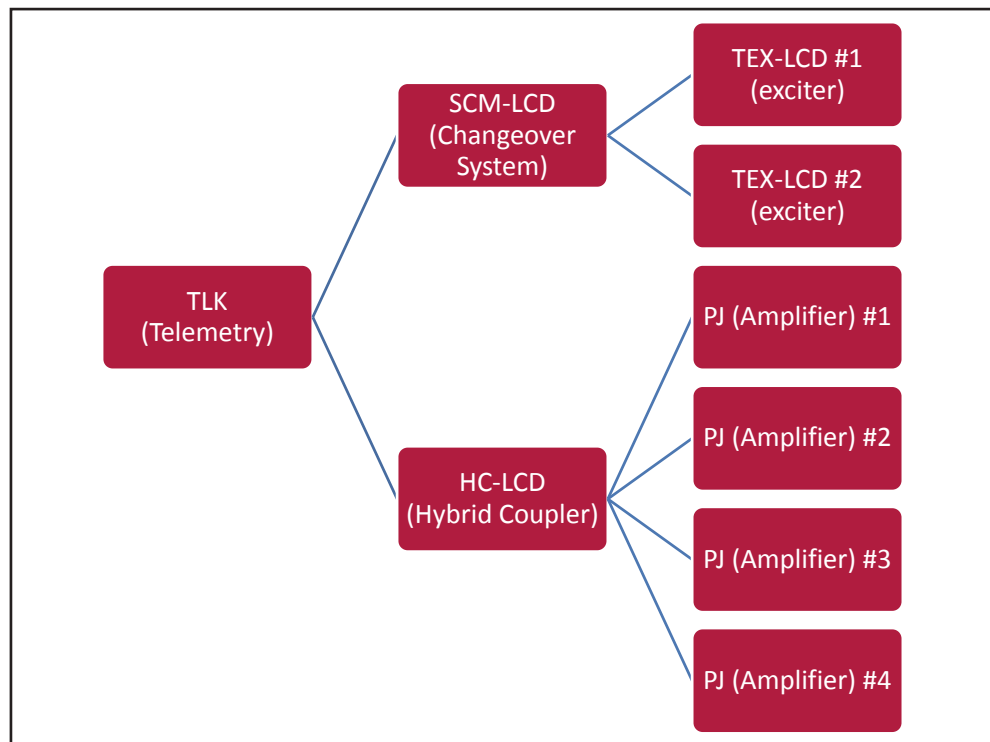

Configuration #10: System

### 10.1.10.1 Configuration of Dip Switch for System 10

	1	2	3	4	5	6	7	8	1	2	3	4	5	6	7	8
Config TX 10										x		x				

Configuration #10: Dip Switch

10.1.10.2 I<sup>2</sup>C Address for System 10

adr	TEX#1	TEX#2	SCM	HC o PA	PA	PA	PA	PA	PA
<b>Config 10</b>	1	2	3	4	5	6	7	8	

*Configuration #10: I<sup>2</sup>C Address*

## 10.1.11 Configuration of System 11

ITEM OGGETTO	COMPOSITION COMPOSIZIONE	READINGS/COMMANDS MENU TABS SCHEDE MENU' READINGS/COMMANDS
1	TLK (telemetry/telemetria)	TX Measures TX Alarm Status
2	SCM-LCD (changeovere/ scambiatore)	SCM Measures
3	2x TEX-LCD (exciter/eccitatore)	Exc #n Measures Exc #n Measures
4	HC-LCD (hybrid coupler/accoppiatore ibrido)	HC Measures
5	5x PJ (amplifier/amplificatore)	PA #n Measure PA #n Measure PA #n Measure PA #n Measure PA #n Measure

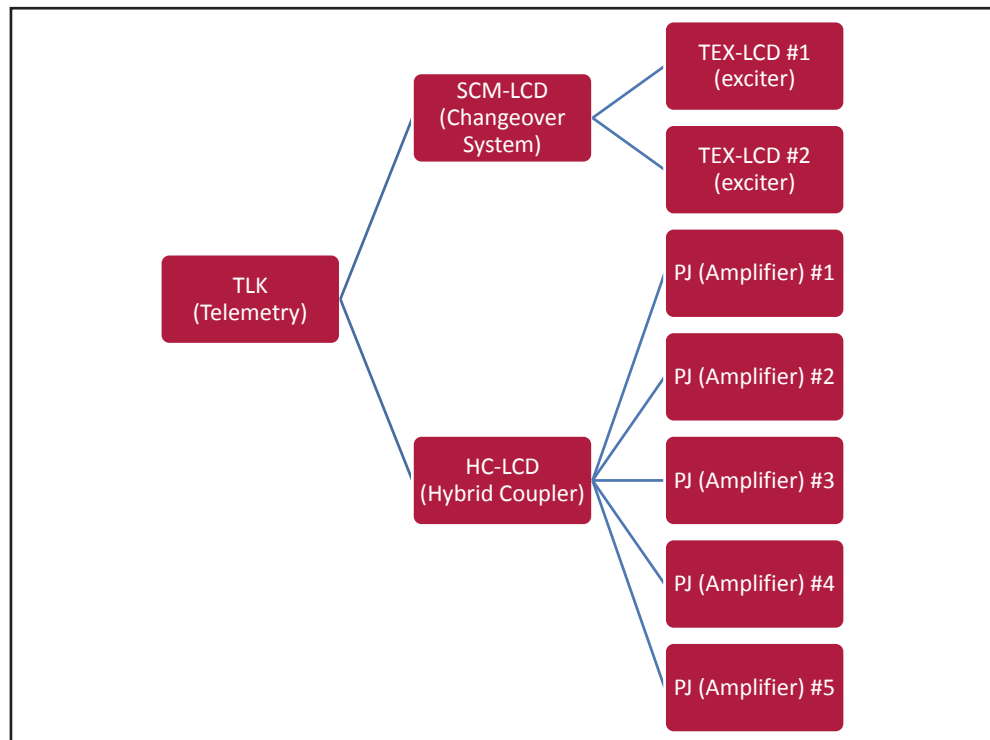

Configuration #11: System

### 10.1.11.1 Configuration of Dip Switch for System 11

	1	2	3	4	5	6	7	8	1	2	3	4	5	6	7	8
Config TX 11									X	X		X				

Configuration #11: Dip Switch

10.1.11.2 I<sup>2</sup>C Address for System 11

adr	TEX#1	TEX#2	SCM	HC o PA	PA	PA	PA	PA	PA
<b>Config 11</b>	1	2	3	4	5	6	7	8	9

*Configuration #11: I<sup>2</sup>C Address*

## 10.1.12 Configuration of System 12

ITEM OGGETTO	COMPOSITION COMPOSIZIONE	READINGS/COMMANDS MENU TABS SCHEDE MENU' READINGS/COMMANDS
1	TLK (telemetry/telemetria)	TX Measures TX Alarm Status
2	PTX-LCD (exciter/eccitatore)	Exc #n Measures

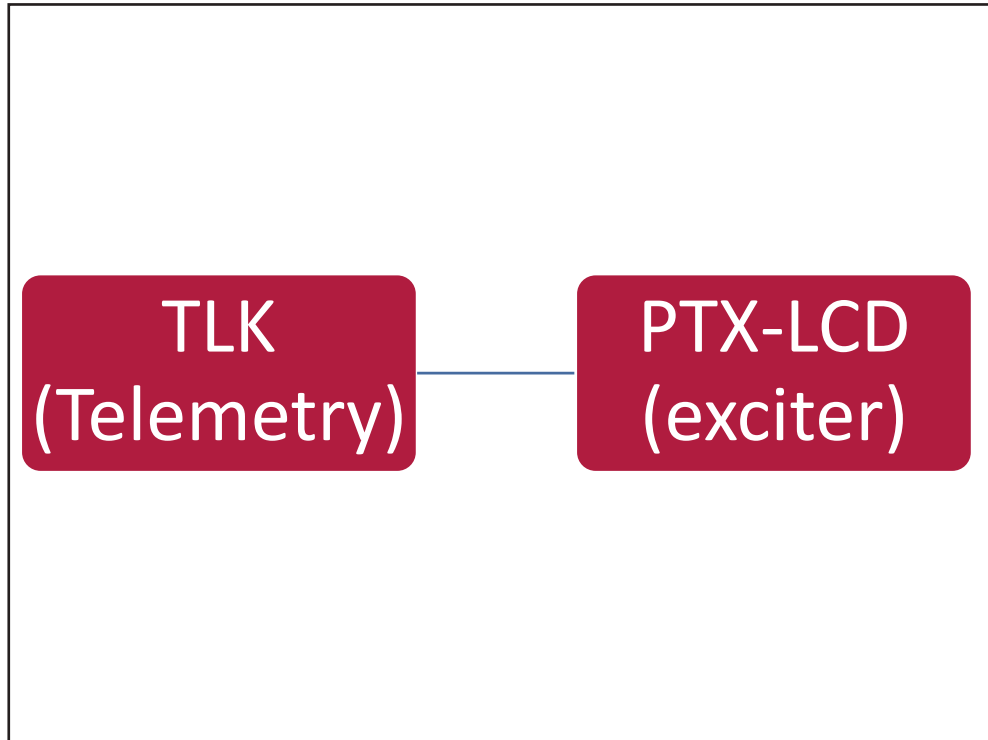

Configuration #12: **System**

### 10.1.12.1 Configuration of Dip Switch for System 12

	1	2	3	4	5	6	7	8	1	2	3	4	5	6	7	8
Config TX 12											x	x				

Configuration #12: **Dip Switch**

### 10.1.12.2 I<sup>2</sup>C Address for System 12

adr	PTX#1	PTX#2	SCM	HC o PA	PA	PA	PA	PA	PA
Config 12	1								

Configuration #12: **I<sup>2</sup>C Address**

10.1.13 Configuration of System 13

ITEM OGGETTO	COMPOSITION COMPOSIZIONE	READINGS/COMMANDS MENU TABS SCHEDE MENU' READINGS/COMMANDS
1	TLK (telemetry/telemetria)	TX Measures TX Alarm Status
2	PTX-LCD (exciter/eccitatore)	Exc #n Measures
3	PJ (amplifier/amplificatore)	PA #n Measure

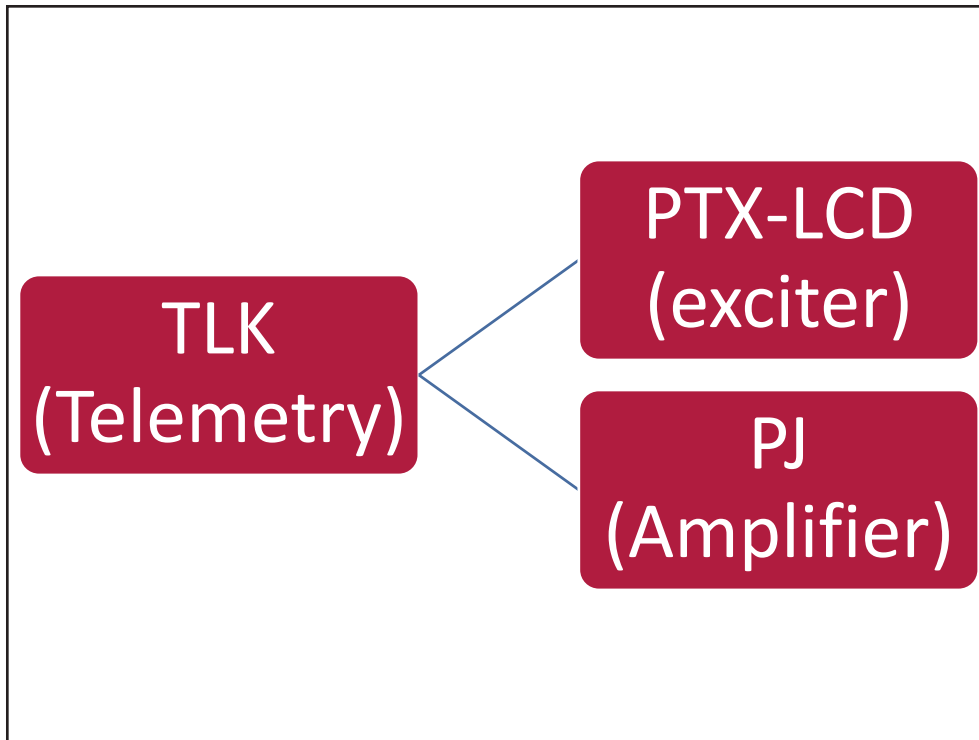

Configuration #13: System

10.1.13.1 Configuration of Dip Switch for System 13

	1	2	3	4	5	6	7	8	1	2	3	4	5	6	7	8
Config TX 13									x		x	x				

Configuration #13: Dip Switch

10.1.13.2 I<sup>2</sup>C Address for System 13

adr	PTX#1	PTX#2	SCM	HC o PA	PA	PA	PA	PA	PA
Config 13	1			4					

Configuration #13: I<sup>2</sup>C Address

## 10.1.14 Configuration of System 14

ITEM OGGETTO	COMPOSITION COMPOSIZIONE	READINGS/COMMANDS MENU TABS SCHEDE MENU' READINGS/COMMANDS
1	TLK (telemetry/telemetria)	TX Measures TX Alarm Status
2	PTX-LCD (exciter/eccitatore)	Exc #n Measures
3	HC-LCD (hybrid coupler/accoppiatore ibrido)	HC Measures
4	2x PJ (amplifier/amplificatore)	PA #n Measure PA #n Measure

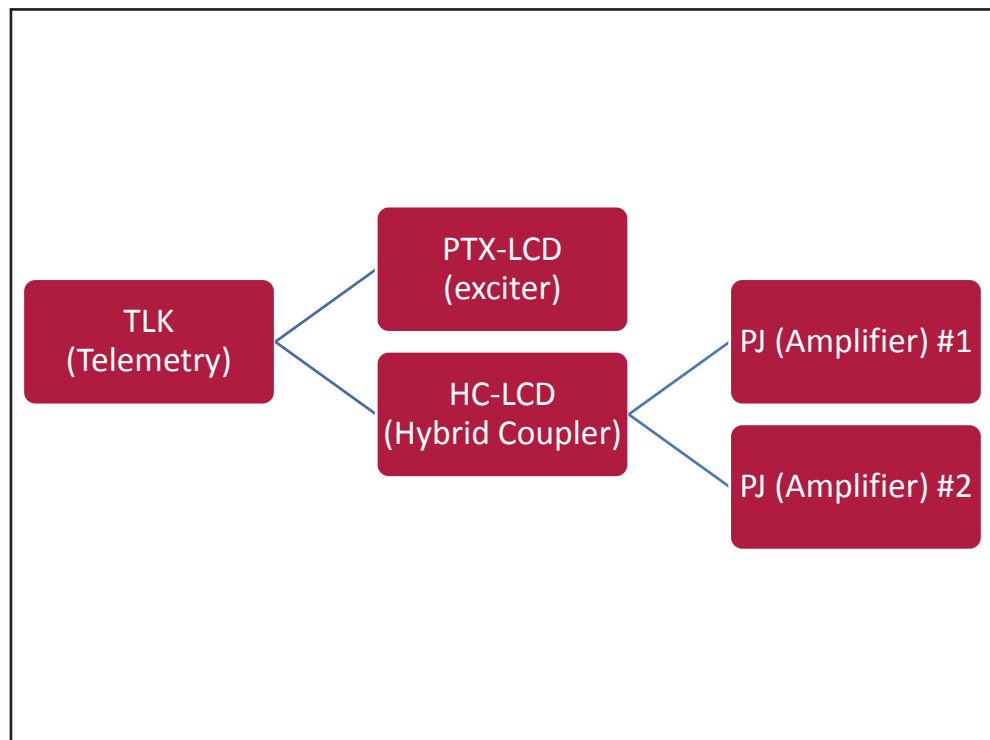

Configuration #14: **System**

### 10.1.14.1 Configuration of Dip Switch for System 14

	1	2	3	4	5	6	7	8	1	2	3	4	5	6	7	8
Config TX 14										x	x	x				

Configuration #14: **Dip Switch**

### 10.1.14.2 I<sup>2</sup>C Address for System 14

adr	PTX#1	PTX#2	SCM	HC o PA	PA	PA	PA	PA	PA
Config 14	1			4	5	6			

Configuration #14: **I<sup>2</sup>C Address**

## 10.1.15 Configuration of System 15

ITEM OGGETTO	COMPOSITION COMPOSIZIONE	READINGS/COMMANDS MENU TABS SCHEDE MENU' READINGS/COMMANDS
1	TLK (telemetry/telemetria)	TX Measures
2	PTX-LCD (exciter/eccitatore)	TX Alarm Status
3	HC-LCD (hybrid coupler/accoppiatore ibrido)	Exc #n Measures
4	3x PJ (amplifier/amplificatore)	HC Measures
		PA #n Measure
		PA #n Measure
		PA #n Measure

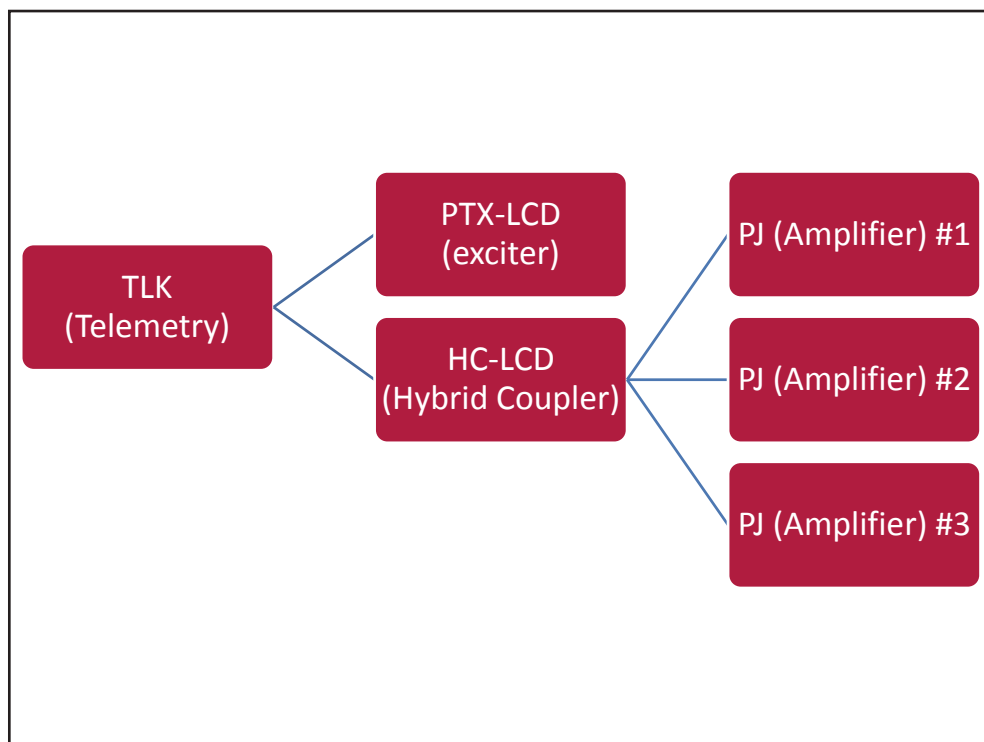

Configuration #15: System

### 10.1.15.1 Configuration of Dip Switch for System 15

	1	2	3	4	5	6	7	8	1	2	3	4	5	6	7	8
Config TX 15									x	x	x	x				

Configuration #15: Dip Switch

### 10.1.15.2 I<sup>2</sup>C Address for System 15

adr	PTX#1	PTX#2	SCM	HC o PA	PA	PA	PA	PA	PA
Config 15	1			4	5	6	7		

Configuration #15: I<sup>2</sup>C Address



## 10.1.16 Configuration of System 16

ITEM OGGETTO	COMPOSITION COMPOSIZIONE	READINGS/COMMANDS MENU TABS SCHEDE MENU' READINGS/COMMANDS
1	TLK (telemetry/telemetria)	TX Measures TX Alarm Status
2	PTX-LCD (exciter/eccitatore)	Exc #n Measures
3	HC-LCD (hybrid coupler/accoppiatore ibrido)	HC Measures
4	4x PJ (amplifier/amplificatore)	PA #n Measure PA #n Measure PA #n Measure PA #n Measure

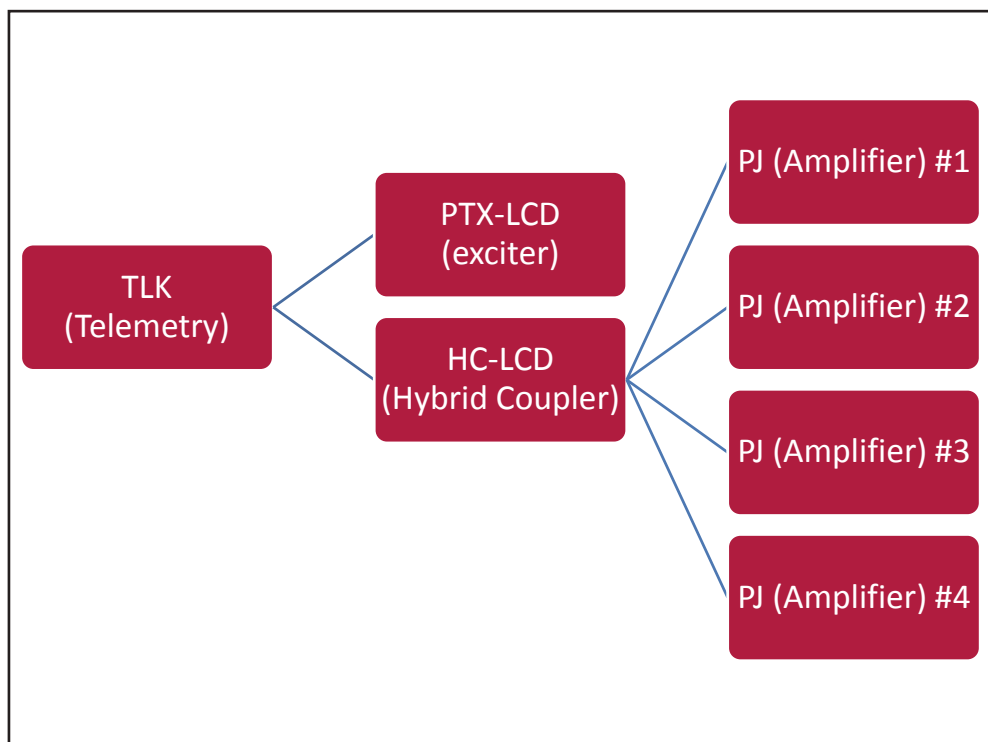

Configuration #16: System

### 10.1.16.1 Configuration of Dip Switch for System 16

	1	2	3	4	5	6	7	8	1	2	3	4	5	6	7	8
Config TX 16													x			

Configuration #16: Dip Switch

### 10.1.16.2 I<sup>2</sup>C Address for System 16

adr	PTX#1	PTX#2	SCM	HC o PA	PA	PA	PA	PA	PA
Config 16	1			4	5	6	7	8	

Configuration #16: I<sup>2</sup>C Address

10.1.17 Configuration of System 17

ITEM OGGETTO	COMPOSITION COMPOSIZIONE	READINGS/COMMANDS MENU TABS SCHEDE MENU' READINGS/COMMANDS
1	TLK (telemetry/telemetria)	TX Measures TX Alarm Status
2	PTX-LCD (exciter/eccitatore)	Exc #n Measures
3	HC-LCD (hybrid coupler/accoppiatore ibrido)	HC Measures
4	5x PJ (amplifier/amplificatore)	PA #n Measure PA #n Measure PA #n Measure PA #n Measure PA #n Measure

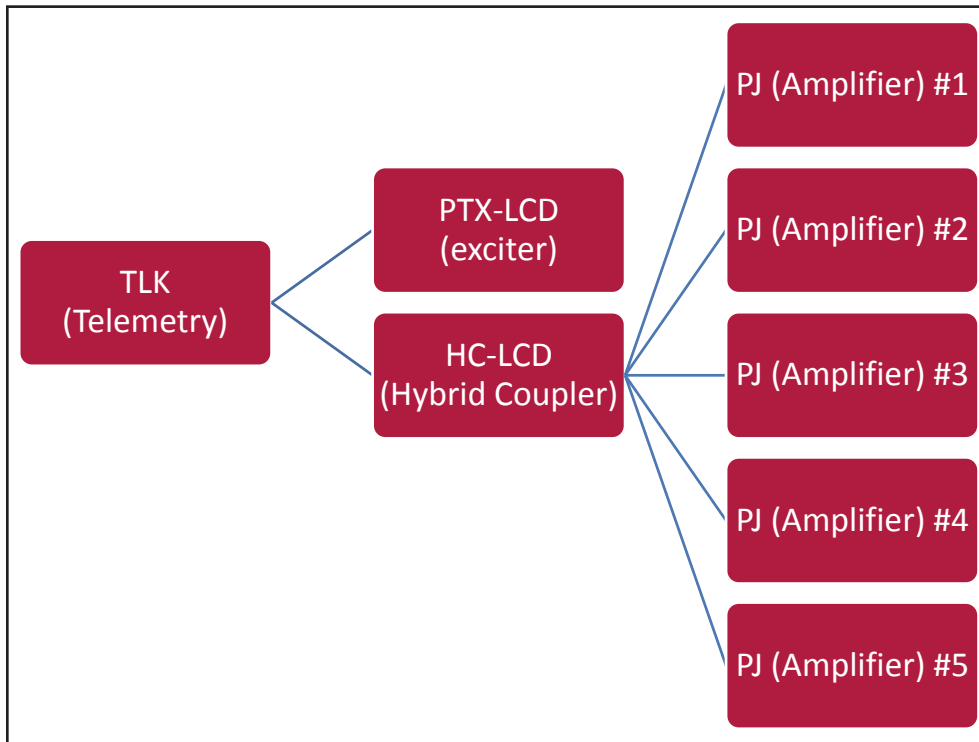

Configuration #17: **System**

10.1.17.1 Configuration of Dip Switch for System 17

	1	2	3	4	5	6	7	8	1	2	3	4	5	6	7	8
Config TX 17									x				x			

Configuration #17: **Dip Switch**

### 10.1.17.2 I<sup>2</sup>C Address for System 17

adr	PTX#1	PTX#2	SCM	HC o PA	PA	PA	PA	PA	PA
<b>Config 17</b>	1			4	5	6	7	8	9

*Configuration #17: I<sup>2</sup>C Address*

10.1.18 Configuration of System 18

ITEM OGGETTO	COMPOSITION COMPOSIZIONE	READINGS/COMMANDS MENU TABS SCHEDE MENU' READINGS/COMMANDS
1	TLK (telemetry/telemetria)	TX Measures
		TX Alarm Status
2	SCM-LCD (changeovere/ scambiatore)	SCM Measures
3	2x PTX-LCD (exciter/eccitatore)	Exc #n Measures
		Exc #n Measures
4	PJ (amplifier/amplificatore)	PA #n Measure

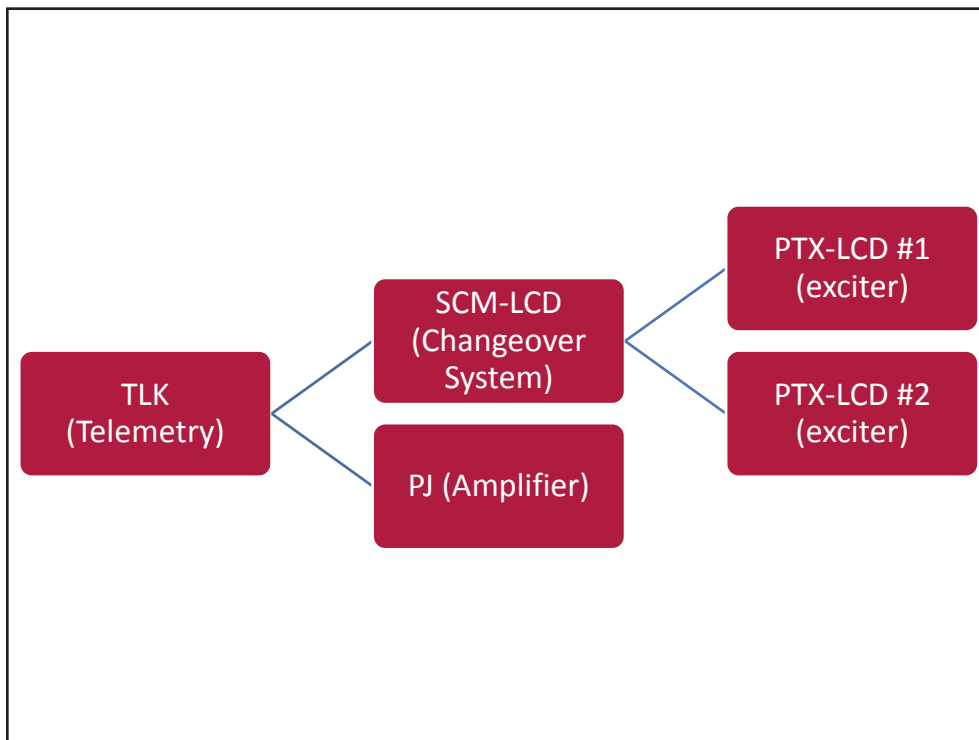

Configuration #18: **System**

10.1.18.1 Configuration of Dip Switch for System 18

	1	2	3	4	5	6	7	8	1	2	3	4	5	6	7	8
Config TX 18										x			x			

Configuration #18: **Dip Switch**

10.1.18.2 I<sup>2</sup>C Address for System 18

adr	PTX#1	PTX#2	SCM	HC o PA	PA	PA	PA	PA	PA
<b>Config 18</b>	1	2	3	4					

Configuration #18: **I<sup>2</sup>C Address**

## 10.1.19 Configuration of System 19

ITEM OGGETTO	COMPOSITION COMPOSIZIONE	READINGS/COMMANDS MENU TABS SCHEDE MENU' READINGS/COMMANDS
1	TLK (telemetry/telemetria)	TX Measures TX Alarm Status
2	SCM-LCD (changeovere/ scambiatore)	SCM Measures
3	2x PTX-LCD (exciter/eccitatore)	Exc #n Measures Exc #n Measures
4	HC-LCD (hybrid coupler/accoppiatore ibrido)	HC Measures
5	2x PJ (amplifier/amplificatore)	PA #n Measure PA #n Measure

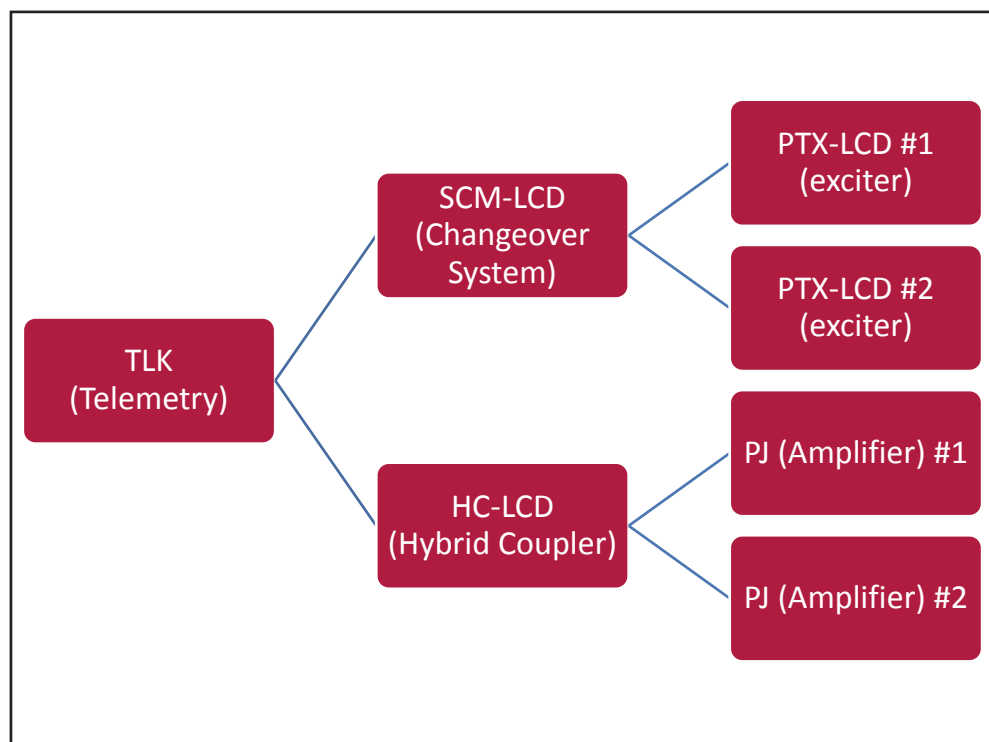

Configuration #19: System

### 10.1.19.1 Configuration of Dip Switch for System 19

	1	2	3	4	5	6	7	8	1	2	3	4	5	6	7	8
Config TX 19									x	x			x			

Configuration #19: Dip Switch

### 10.1.19.2 I<sup>2</sup>C Address for System 19

adr	PTX#1	PTX#2	SCM	HC o PA	PA	PA	PA	PA	PA
Config 19	1	2	3	4	5	6			

Configuration #19: I<sup>2</sup>C Address

10.1.20 Configuration of System 20

ITEM OGGETTO	COMPOSITION COMPOSIZIONE	READINGS/COMMANDS MENU TABS SCHEDE MENU' READINGS/COMMANDS
1	TLK (telemetry/telemetria)	TX Measures TX Alarm Status
2	SCM-LCD (changeovere/ scambiatore)	SCM Measures
3	2x PTX-LCD (exciter/eccitatore)	Exc #n Measures Exc #n Measures
4	HC-LCD (hybrid coupler/accoppiatore ibrido)	HC Measures
5	3x PJ (amplifier/amplificatore)	PA #n Measure PA #n Measure PA #n Measure

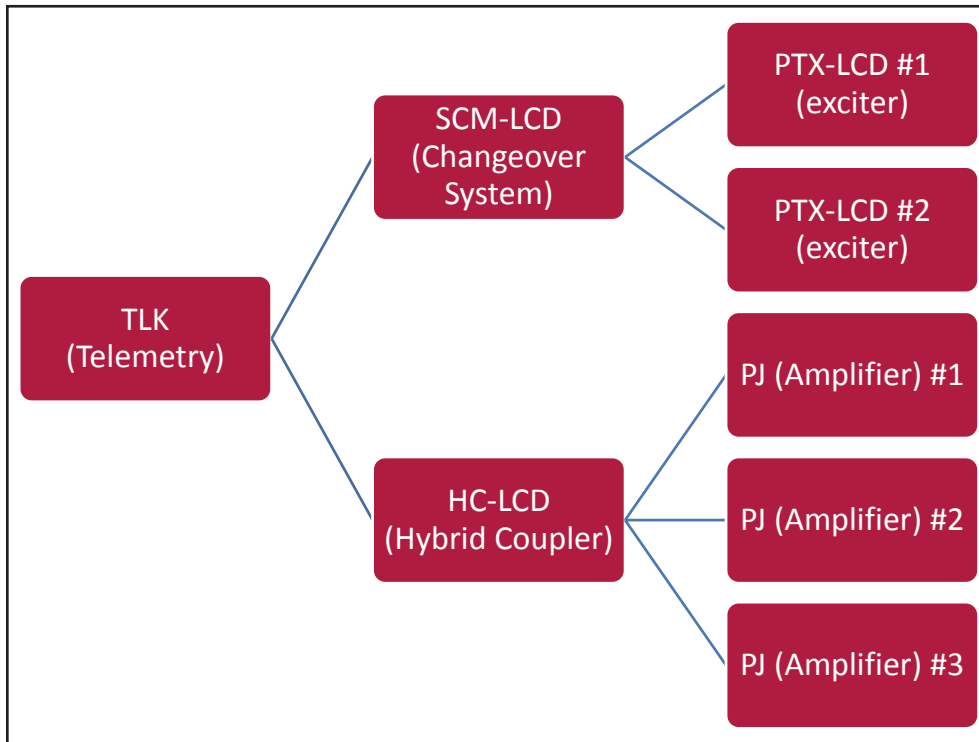

Configuration #20: **System**

10.1.20.1 Configuration of Dip Switch for System 20

	1	2	3	4	5	6	7	8	1	2	3	4	5	6	7	8
Config TX 20											x		x			

Configuration #20: **Dip Switch**

### 10.1.20.2 I<sup>2</sup>C Address for System 20

adr	PTX#1	PTX#2	SCM	HC o PA	PA	PA	PA	PA	PA
<b>Config 20</b>	1	2	3	4	5	6	7		

*Configuration #20: I<sup>2</sup>C Address*

10.1.21 Configuration of System 21

ITEM OGGETTO	COMPOSITION COMPOSIZIONE	READINGS/COMMANDS MENU TABS SCHEDE MENU' READINGS/COMMANDS
1	TLK (telemetry/telemetria)	TX Measures TX Alarm Status
2	SCM-LCD (changeovere/ scambiatore)	SCM Measures
3	2x PTX-LCD (exciter/eccitatore)	Exc #n Measures Exc #n Measures
4	HC-LCD (hybrid coupler/accoppiatore ibrido)	HC Measures
5	4x PJ (amplifier/amplificatore)	PA #n Measure PA #n Measure PA #n Measure PA #n Measure

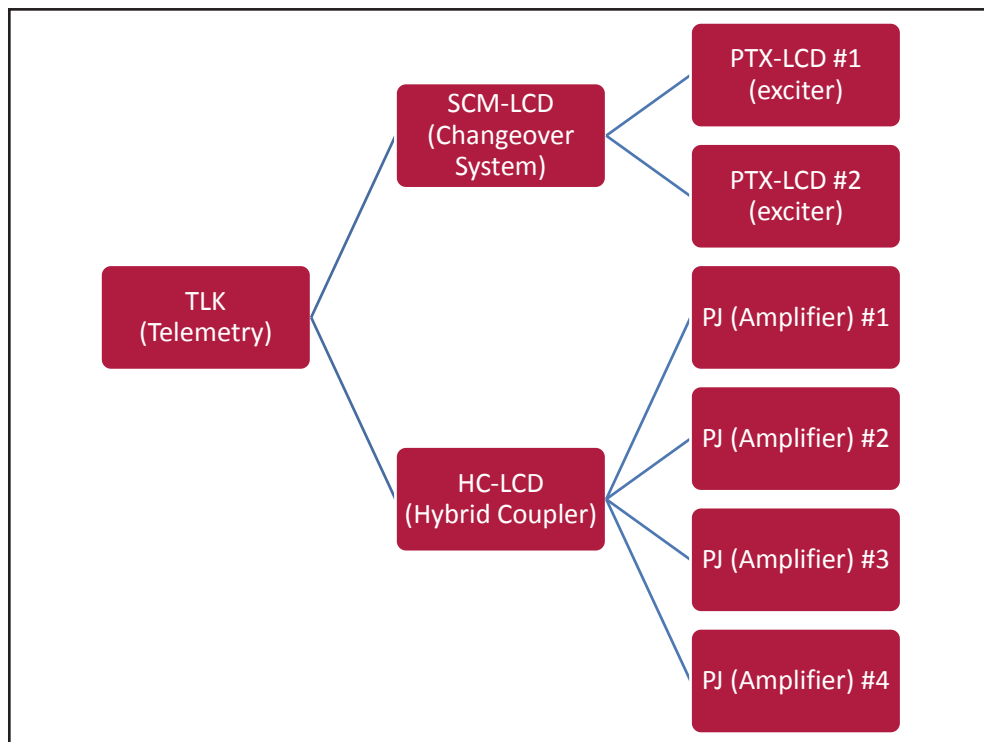

Configuration #21: **System**

10.1.21.1 Configuration of Dip Switch for System 21

	1	2	3	4	5	6	7	8	1	2	3	4	5	6	7	8
Config TX 21									x		x		x			

Configuration #21: **Dip Switch**



### 10.1.21.2 I<sup>2</sup>C Address for System 21

adr	PTX#1	PTX#2	SCM	HC o PA	PA	PA	PA	PA	PA
<b>Config 21</b>	1	2	3	4	5	6	7	8	

*Configuration #21: I<sup>2</sup>C Address*

10.1.22 Configuration of System 22

ITEM OGGETTO	COMPOSITION COMPOSIZIONE	READINGS/COMMANDS MENU TABS SCHEDE MENU' READINGS/COMMANDS
1	TLK (telemetry/telemetria)	TX Measures TX Alarm Status
2	SCM-LCD (changeovere/ scambiatore)	SCM Measures
3	2x PTX-LCD (exciter/eccitatore)	Exc #n Measures Exc #n Measures
4	HC-LCD (hybrid coupler/accoppiatore ibrido)	HC Measures
5	5x PJ (amplifier/amplificatore)	PA #n Measure PA #n Measure PA #n Measure PA #n Measure PA #n Measure

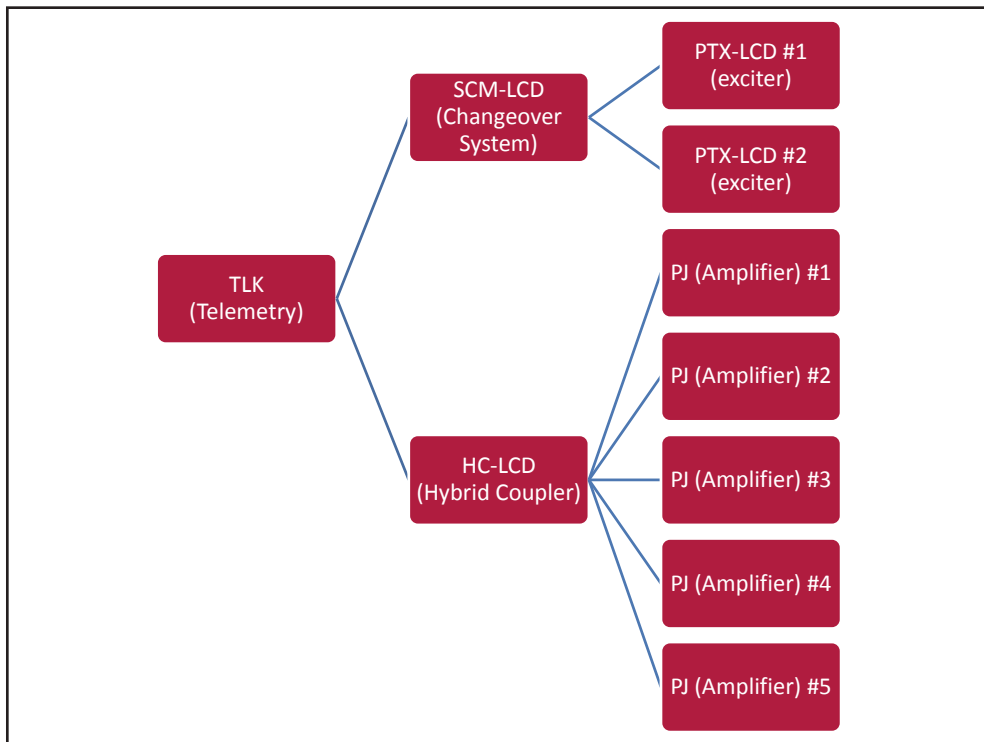

Configuration #22: **System**

10.1.22.1 Configuration of Dip Switch for System 22

	1	2	3	4	5	6	7	8	1	2	3	4	5	6	7	8
Config TX 22									x	x		x				

Configuration #22: **Dip Switch**

### 10.1.22.2 I<sup>2</sup>C Address for System 22

adr	PTX#1	PTX#2	SCM	HC o PA	PA	PA	PA	PA	PA
<b>Config 22</b>	1	2	3	4	5	6	7	8	9

*Configuration #22: I<sup>2</sup>C Address*

## 11. SNMP Telemetry

SNMP (Simple Network Management Protocol) is a worldwide protocol that allows the management and supervision of the equipment connected to the network.

Measurements and commands are described by a MIB (Management Information Base), which is a list of OID (Object Identifier). Each OID is a variable that can be written (SET) or read (GET) through a NMS (Network Management System) compatible with SNMP.

The MIB is a text file written in ASN.1 and it is imported from the NMS in order to know what OID can be expected by the AGENT (proxy card) and how to interpret the information received.

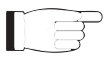

**Nota :** *The user can not freely distribute the MIB, unless written authorization issued by the manufacturer. The MIB is property of the manufacturer.*

The SNMP version used in this application is the v2, and is compatible with all NMS systems.

New Status:	<input type="text"/>
New Read Community:	<input type="text" value="public"/>
New Write Community:	<input type="text" value="private"/>
New Primary Trap IP:	<input type="text" value="192.168.0.41"/>
New Secondary Trap IP:	<input type="text" value="192.168.0.41"/>
Main Mib:	<a href="#">rvr-main-mib.mib</a>
Specific Mib:	<a href="#">rvr-tlk-v3-v4-mib.mib</a>

Menu 1



**Nota :** *Use a MIB BROWSER (not included) to use the MIB of RVR equipments. These are usually provided in an accompanying CD with the system in which the TLK301 is installed.*

### 11.1 MAIN MIB Description

The MAIN MIB reads and manages the main parameters of **TLK300 & TLK2000** and provides general information related to manufacturer.

Through this MIB you can read, and in some cases set, parameters such as IP address, Netmask, Gateway and DNS address.

It is also possible to manage IP address, time and date stored within the telemetry system.

In cases where the parameter is a read-only, and you can not change it, it will be indicated by a red X over the icon reference. In some cases to apply a particular change, it is necessary to click on the OID item “Apply Changes”.



**Note :** In the following examples is used a MIB browser of ManageEngine, but any MIB Browser can be used.

## 11.1.1 Reading and Settings of parameters

The description of each variable is specified inside MIB, which are subsequently reported in the description box (Description) at the end.

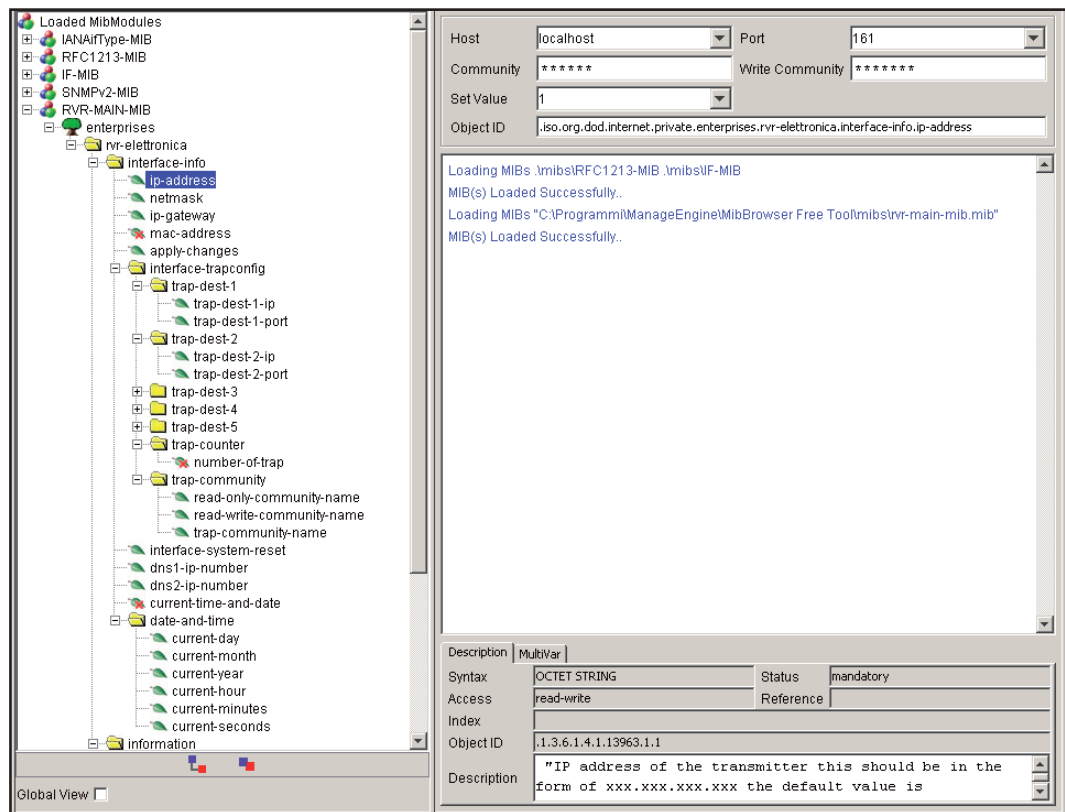

Menu 2

The telemetry system is capable of sending Trap up to two different addresses. Different addresses can be set using the OID in major MIB, in this case:

- IP address for the destination of the Trap.

## 11.2 SPECIFIC MIB Description

The SPECIFIC MIB reads and manages the parameters administrated by TLK301 included in transmitter station.

Through this MIB you can read powers (forward, reflected or unbalanced), temperature, voltages and currents on modules of possible amplifiers, exciters and changeovers connected to **TLK301**.



**Note :** In MIB browser will always display the maximum configuration of amplifiers, exciters and changeover available. The machines not present, will report zero readings.

It is also possible to manage to control the switching on or off of transmitter, the alarm reset, automatic or manual changeover.

In cases where the parameter is a read-only, and you can not change it, it will be indicated by a red X over the icon reference. In some cases to apply a particular change, it is necessary to click on the OID item “Apply Changes”.



**Note :** In the following examples is used a MIB browser of ManageEngine, but any MIB Browser can be used.

## 11.2.1 Reading of Measurement

Each transmitter has a range of measures that can be read.

The description of each variable is specified inside MIB, which are subsequently reported in the description box (Description) at the end..

The screenshot shows the ManageEngine MIB browser interface. On the left, a tree view displays the hierarchy of MIB objects under 'RVR-TLK-V3-V4-MIB'. The selected object is 'forward-power' under the path 'tkk-tlk-v3-v4.readings.power-readings.system-1-power.system-power-readings'. The right pane shows the configuration for this object, including Host (localhost), Port (161), and Object ID (tkk.tlk-v3-v4.readings.power-readings.system-1-power.system-power-readings.forward-power). Below this, a log shows the successful loading of MIBs. At the bottom, a table provides details for the selected object:

Description	Multivar	Status	mandatory
Syntax	INTEGER	Reference	
Access	read-only		
Index			
Object ID	.1.3.6.1.4.1.13963.4.150.1.1.1.1.1.1		
Description	"Total forward power expressed in WATTS. This is the total output of the transmitter. "		

Menu 3

## 11.2.1 Reading of Status

Similarly to measurements, each transmitter has a range of states that can be read.

The description of each variable is specified inside MIB, which are subsequently reported in the description box (Description) at the end.

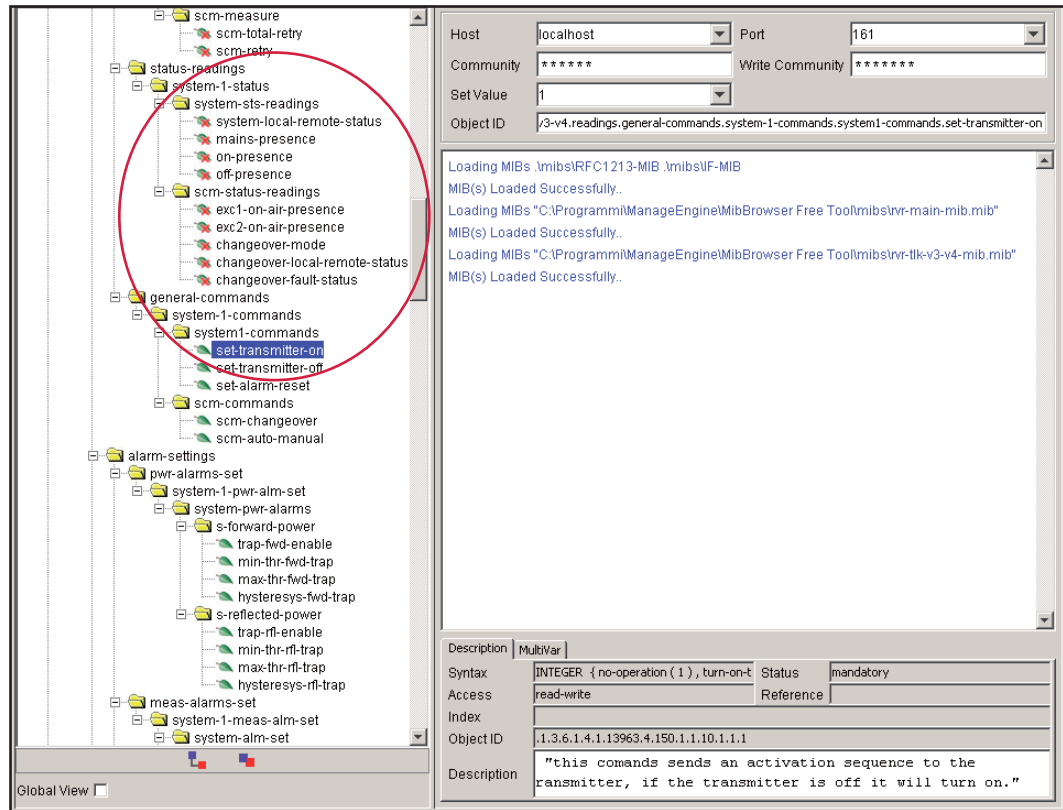

Description	MultiVar
Syntax	INTEGER { no-operation ( 1 ), turn-on-t Status mandatory
Access	read-write Reference
Index	
Object ID	.1.3.6.1.4.1.13963.4.150.1.1.10.1.1.1
Description	"this comands sends an activation sequence to the transmitter, if the transmitter is off it will turn on."

Menu 4

The indications on the states can be of three types:

- **0** Indication of absence of the transmitter system component.
- **1** Indication of ON state, presence or activation of parameter.
- **2** Indication of OFF state, absence or deactivation of parameter.

## 11.2.2 Comand sending

Similarly to measurements, the commands have a number of OID that are only in write mode. For each transmitter, the MIB export a specific set of OID.

The commands set are of two types: bistable (ON / OFF) or impulsive type.

- **Bistable control:** in order to activate (ON), the user must send a "2" as value; in order to disable (OFF), the user must send a "1" as value. No other value is accepted like a command.

- **Impulsive control:** typically the commands are impulsive type. In other words, if you put the transmitter “ON” (“2” value), the next command is “OFF” (“2” value) and not a disable for “ON” command (“1” value).

The screenshot shows a network management interface. On the left is a tree view of the device's configuration. The 'system1-commands' folder is expanded, and 'set-transmitter-on' is highlighted with a red circle. On the right, a detailed view of this command is shown. The 'Host' is 'localhost' and the 'Port' is '161'. The 'Community' is '\*\*\*\*\*' and the 'Write Community' is '\*\*\*\*\*'. The 'Set Value' is '1'. The 'Object ID' is '/3-v4.readings.general-commands.system-1-commands.system1-commands.set-transmitter-on'. Below this, there is a log showing MIBs being loaded successfully. At the bottom, a table provides details for the command:

Description	Multivar	Status	mandatory
Syntax	INTEGER {no-operation (1), turn-on-t	Reference	
Access	read-write		
Index			
Object ID	.1.3.6.1.4.1.13963.4.150.1.1.10.1.1.1		
Description	"this comands sends an activation sequence to the transmitter, if the transmitter is off it will turn on."		

Menu 5



**Note:** In the example above, all controls are impulsive type.

### 11.2.3 Reading and Settings of Trap

For each Trap related to measurement can be set:

- Enabler Trap command on a power measure.
- The minimum value (MIN) is the fixed point below which is sent a Trap.
- The maximum value (MAX) is the fixed point beyond which is sent a Trap.
- The hysteresis value is a nominal value that the system adds (or subtracts) to real value in order to exit from alarm condition. In other words, it is helpful to avoid situations of continuous alarm, if readout is very close to the set point alarm.



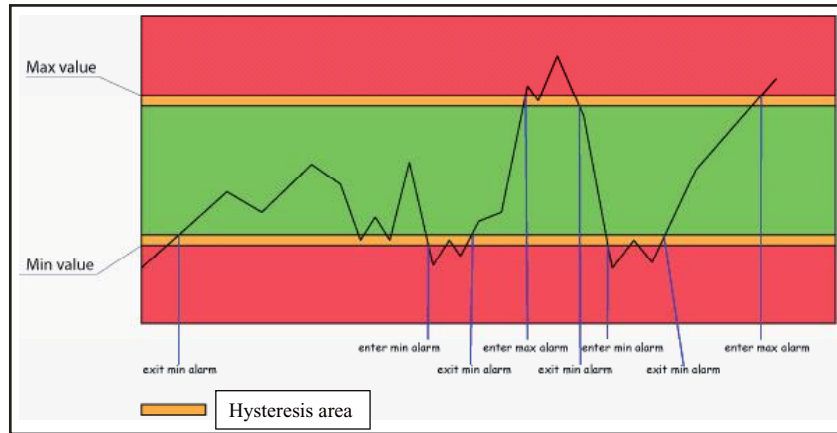

Menu 6

As you can see the hysteresis is a protected area in which the alarm is not sent, when the value exceeds the minimum value (MIN) when there is no alarm or the maximum value (MAX) alarm is active, the minimum value (MIN) alarm is set. To exit the MIN alarm condition, the value should be equal to the MIN value plus the value of hysteresis.



**Note :** the hysteresis value must be less than  $\frac{1}{2}$  referred to distance between the minimum value (MIN) and maximum value (MAX).

An example of an analog alarm setting, are included in the following section in the SNMP tree:

Description	Multivar
Syntax	INTEGER {no-operation(1), turn-on}
Status	mandatory
Access	read-write
Reference	
Index	
Object ID	1.3.6.1.4.1.13963.4.150.1.1.10.1.1.1
Description	"this comands sends an activation sequence to the transmitter, if the transmitter is off it will turn on."

Menu 7

An example of an alarm where you can edit only the enabler of states is shown below:

Description	Multivar
Syntax	INTEGER {no-operation (1), turn-on-t Status mandatory
Access	read-write Reference
Index	
Object ID	.1.3.6.1.4.1.13963.4.150.1.1.10.1.1.1
Description	"this comands sends an activation sequence to the ransmitter, if the transmitter is off it will turn on."

Menu 8

Below are shown the OID descriptions of the trap sent by system:

Menu 9

## 12. Connecting TLK to Internet network

In order to connect the system to the public network TLK you must have an internet connection typically provided through a router with NAT (Network Address Translation), which allows devices connected to the LAN to go out with the number router's public IP and protect any attempts at forcing.

In case you have connecting directly with the public IP address on the LAN socket is advisable to insert a router / firewall to avoid exposing the system TLK directly to the public network but manage only the ports used by TLK for the functions of the web interface, SNMP, and SMTP .

The system uses incoming port 80, can not be changed, such as web interface visible from any Web Browser and port 161 can not be changed, such as SNMP port.

For sending the email TLK uses port 25, modifiable, and port 162 can not be changed, for the sending of SNMP Trap.

To ensure that the TLK is visible from the outside is necessary that the router / firewall is set up port forwarding, the function can have different names depending on the brand of your router.

The public port 80 from IP to the IP of TLK for WEB and port 161 of the public interface to the IP of TLK for SNMP data.

To ensure that the unit can send the Trap and the Email needs to be able to use the network at its output ports 162 for Trap and the port 25 for email.

To send the e-mail system TLK uses the MX record for the target domain DNS asked that must be set correctly in the appropriate fields otherwise not be able to send emails.

Also for the emails you must make sure that the destination server accept email from the public IP of our digestive system because the ships directly to the destination SMTP server without going through a server forward as is usual practice for mailers electronics installed on personal computers.

The apparatus as said default IP is set to RVR as 192.168.0.244 and will be adjusted on the network configured as your router's LAN port is used for port forwarding.

If you have multiple devices connected to the LAN after the router is necessary to use different ports on the public interface that will be routed to the fixed ports of the devices TLK must have a LAN IP different from each other.

- TLK#1 IP 192.168.0.244 Port forwarding port 80 > port 80 of 192.168.0.244
- TLK#1 IP 192.168.0.244 Port forwarding port 161 > port 161 of 192.168.0.244
- TLK#2 IP 192.168.0.245 Port forwarding port 81 > port 80 of 192.168.0.245
- TLK#2 IP 192.168.0.245 Port forwarding port 163 > port 161 of 192.168.0.245

With this configuration, the apparatus TLK # 1 will be visible from WEB as `http://public.ip` and apparatus TLK # 2 will be visible from as `http://public.ip:81` WEB, SNMP and how you must use port 161 to see the TLK # 1 and port 163 to see the TLK # 2.

To send the Trap or Email being output there is no problem, as long as there are no restrictions on using ports 25 and 162 are wanted by the service provider.

To know the public IP of our apparatus is desirable to have a FIXED IP connection service that is provided by the provider, if the service has a dynamic IP you will have to rely on a DNS service that gives a name to our IP and keep updated in the event of a change of IP in order to reach the TLK always writing the same name.

This service is provided by many providers, some free and some paid, and usually some routers include this function that can handle some of the service providers, and in case you need to use this service will need to be programmed into your router by following the instructions in that, given the various methods used to manage this function, we can not include this function in the system TLK.

In case your network TLK has many systems connected to the Internet the safest way to manage and functional systems is to create a VPN between all stations and the headquarters in order to have all the devices in the same network in order to view them directly with their IP without the limitations of different ports for devices in the same location, not all routers have this programming possibilities, limits the output ports and having to manage any dynamic IP with a DNS service.

In this case, the customer will have to rely on a company that specializes in networks to configure your VPN between locations.



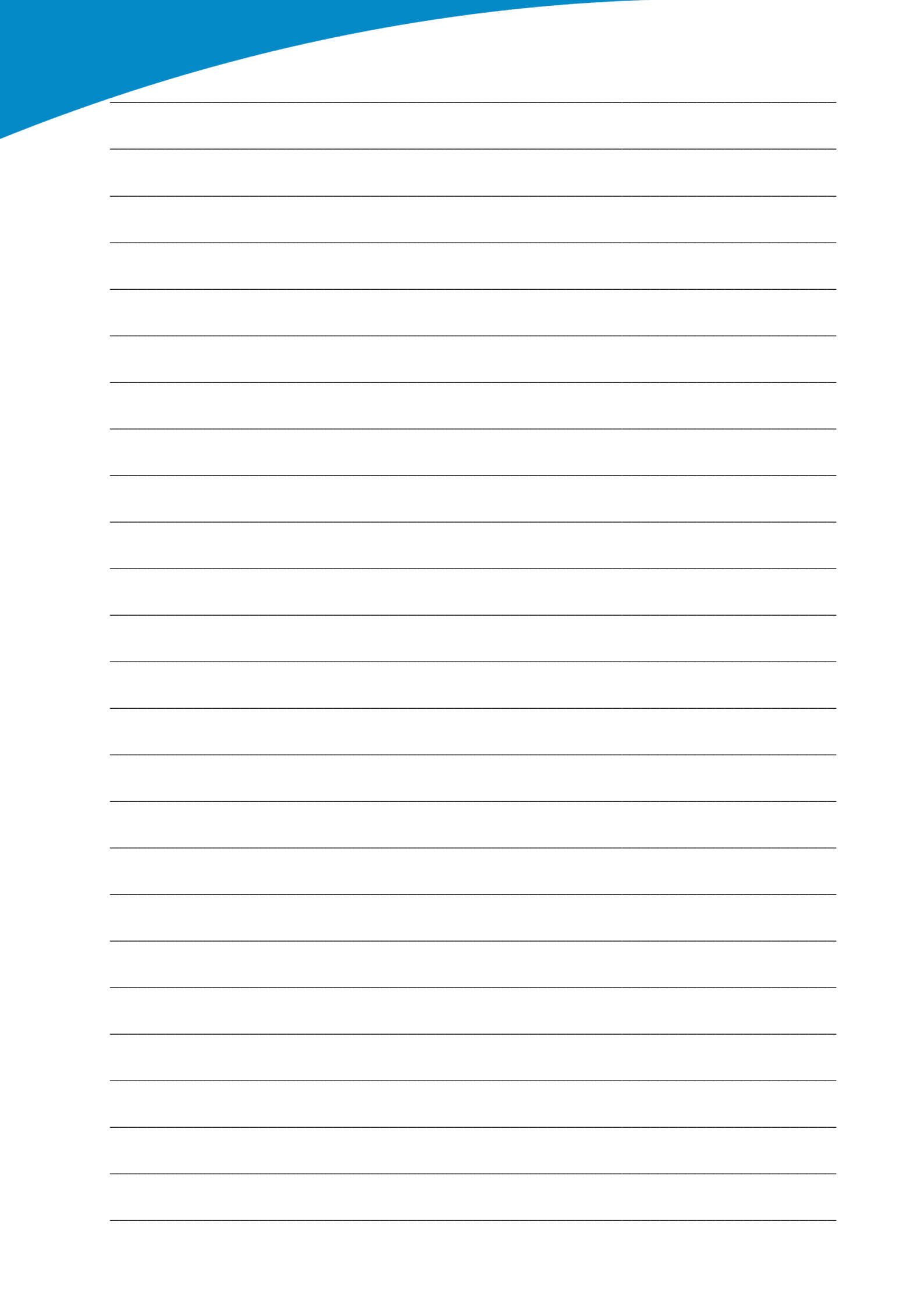





**R.V.R. Elettronica S.r.l.**  
Via del Fonditore 2 / 2c  
40138 · Bologna · Italy  
Phone: +39 051 6010506 · Fax: +39 051 6011104  
e-mail: [info@rvr.it](mailto:info@rvr.it) · web: <http://www.rvr.it>

Member of CISQ Federation



The RVR Logo, and others referenced RVR products and services are trademarks of RVR Elettronica in Italy, other countries or both. RVR © 1998 all rights reserved.  
All other trademarks, trade names or logos used are property of their respective owners.